



Export product catalog

export.frederiksen-scientific.com/

Viaduktvej 35
6870 Ølgod
+45 7524 4966
export@frederiksen-scientific.com

Contents

Physics	2
Chemistry	124
Biology	253
Tech & eng.	346

Physics

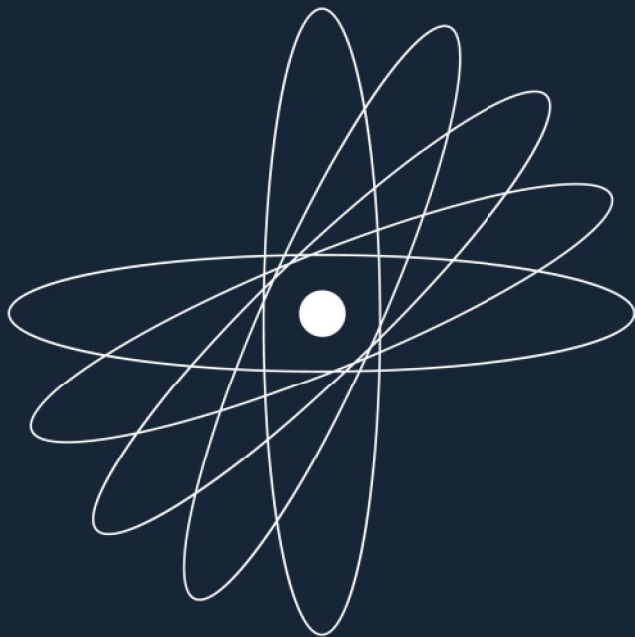



Item: 197561

Photocell holder

Spare part - holder for photocell 197560.



Item: 288740

3 Colour LED Light Source Set

Battery-powered LED laser set consisting of red, green and violet colors. The set is connected with magnets. Batteries are included in the



Item: 489025

Handheld Pyranometer with Di

This instrument is used to measure the global irradiance of sunlight. The instrument is equipped with a display for reading the solar radiation and if data is to be logged



Item: 194515

Balloons, long, 100 pcs

Offset balloons. Can be used for hovercraft order no. 194505.



Item: 195055

Mounting bracket for photocel

Use this mounting bracket to easily mount the [197570](#) SpeedGate or other photocell units on the



Item: 195500

Bumper fork with plug

Elastic fork with prongs. Used in combination with 195510 for elastic shock on an air cushion rail and in conjunction with the 195210 firing mechanism.



Item: 195560

Flag with plug, 25 mm

Used as an aperture for photocell unit for time measurements on the air cushion rail. Weight 5 g.



Item: 195530

Tube with wax and plug

Spare part for accessories for air cushion rail 195050. Used together with 195520 for inelastic impact on an air duster rail.



Item: 195510

Bumper plate with plug

Spare part for accessory air cushion rail; 195050.



Item: 195520

Needle with plug

Used with 195530 for inelastic impact on an air cushion rail.
Weight: 10 g.
Included in 195003 Air



Item: 195590

Armature with plug

Mounted on trolley to the air cushion rail.
This spare part belongs to 195210 - Electric firing mechanism.



Item: 196000

Cart for air track

Spare part / extra trolley for air cushion rail.
The trolley is made of black lacquered aluminum and has mounting holes for accessory



Item: 196300

Slotted weights with holder

Used for acceleration of hovercraft.
The set consists of 2 g holder, 2 weights of 1 g each, 1 weight of 2 g, 1 weight of 5



Item: 196500

Pulley with plug

The pulley is used in acceleration tests with the air cushion rail. Mounted using the pin at one end of the rail.
The mass distribution of the



Item: NL112110

Optical kit with LED

This optics set consists of the following parts:
Aluminum optical bench 100 cm with scale, can also be used as an inclined



Item: NL114045

Universal digital meter, max 10

Universal digital meter max. 10A. Excellent for demonstration and/or practical use. Optimally protected against overload. Operation of these meters is



Item: NL112316

Lens in holder, + 50 mm

The lenses are permanently mounted in the black plastic holders. The focal length is indicated on the frame. The size of the disk is 130 mm ϕ . The stem has a diameter of



Item: NL118521

Optical bench for classroom u

Accessories for NL112110.

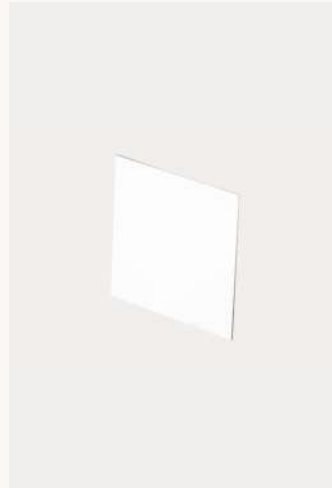

Item: NL122155

Projection screen, 17 x 17 cm,

Projection screen, 17 x 17 cm, white



Item: NL122156

Lens, f = +100 mm, in Holder

Lens, f = +100 mm, in holder

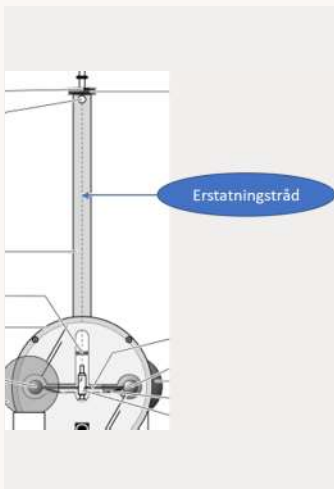

Item: 198055

Sparepart, Wire Fittings for 19

Spare part for 198050 - 26 cm thin copper torsion wire for replacement



Item: NL112317

Lens in Holder, +100 mm

The lenses are fixed in the black plastic fittings. The focal length is indicated on the frame. The size of the disc is 130 mm ϕ . The stem



Item: NL112318

Lens in Holder, +150 mm

The lenses are fixed in the black plastic fittings. The focal length is indicated on the frame. The size of the disc is 130 mm ϕ . The stem



Item: NL122157

Lens, f = +150 mm, in Holder

Lens, f = +150 mm, in holder



Item: NL122158

Lens, f = +200 mm, in Holder

Lens, f = +200 mm, in holder



Item: 217720

Slotted Weights with Holder, N

Solder set with 10 x 10 g weights.



Item: 217730

Slotted Weights with Holder, 1

Diameter: 37 mm.
Iron slotted solder, 100gX10, nickel plated.



Item: NL112319

Lens in Holder, +200 mm

The lenses are fixed in the black plastic fittings. The focal length is indicated on the frame. The size of the disc is 130 mm ø. The stem



Item: NL112320

Lens in Holder, +300 mm

The lenses are fixed in the black plastic fittings. The focal length is indicated on the frame. The size of the disc is 130 mm ø. The stem



Item: NL119218

Slinky spring

This iron spring is suitable for demonstrating wave oscillations.
Diameter 75 mm, length 110 mm



Item: NL122159

Lens, f = +300 mm, in Holder

Lens, f = +300 mm, in holder



Item: 616441

Capacitor, Electrolytic, 1000 µF

Electrolytic capacitor (Elco) from Philips, series AS 030-033/AS 021.
25 V with a capacity of 1000 µF.



Item: NL122160

Lens, f = +50 mm, in Holder

Lens with focal point $f = +50$ mm in lens holder.
 Lens diameter is 50 mm.
 Fits lens holder NL122168.
 Fits rider NL122151.



Item: 670089

Neodymium magnets

Neodymium magnet, $\varnothing 12$ mm, 4 mm - N45.
 Weight: 3.4 g



Item: 224510

Tuning fork, 2 pcs, economy

Used for resonance experiments and demonstration of shock tones.
 The kit consists of two 440 Hz



Item: NL112321

Lens in Holder, -100 mm

The lenses are fixed in the black plastic fittings. The focal length is indicated on the frame. The size of the disc is 130 mm \varnothing . The stem



Item: NL122152

Slider with slot for screen

Rider with slot for projection screen.
 Fits rail NL118521 and part of set NL112110.



Item: 173610

Drinking bird

The bird that drinks and drinks. You may know it from your childhood, but it's still funny. Put a glass in front of the birds, help it take the first sip. After the first sip, it will



Item: 173611

Balancing bird

A beautiful little bird that not only decorates but also arouses curiosity. How can the bird keep its balance?



Item: 178015

Rubber mat f. 178000

Spare part (rubber base) for 178000 Pump disk.
 The rubber washer will deteriorate over time, so it may be a good idea to have a



Item: 178510

Bell jar with knob

This Duran glass pump bell is an accessory part for the pump plate 178020. This is a premium product made of thick and heavy glass of the highest



Item: 178520

Bell jar with tube

This pump bell is an accessory part for pump plate 178020. The air pump bell has a tube at the top of the bell that can be closed with a 31/38 mm rubber stopper.



Item: 178600

Jar with hose connector

For simple experiments with positive or negative pressure. Ordinary "jam jars" with screw cap and gasket. The lid is fitted with a nickel-plated



Item: 180500

Boyle-Mariotte apparatus

To demonstrate the relationship between volume and pressure at constant temperature. The device consists of a



Item: 187605

Anemometer, digital

Electronic anemometer with easy-to-read digital display that directly shows the wind speed in km/h, m/s, knots or feet/minute. The anemometer part is suspended in



Item: 189650

Gamma-Scout with alarm

Rechargeable Geiger counter with alarm function that can be activated when set radiation levels are exceeded.



Item: 190500

Lever arm

Weighing bar with holes indicating the arm length from the center of gravity. Made of 2 mm brass and nickel-plated.



Item: 190510

Rod with pin

Suitable for hanging item number 190500 - Barbell bar. Made of nickel-plated brass. Length: 95 mm.



Item: 191002

Weight with hooks, 200 g

Lead with hook on both ends
Weight: 200 g



Item: 191005

Weight with hooks, 100 g

Lead with hook on both end faces.
Weight: 100 g



Item: 191025

Weight with hooks, 50 g

Lead with hook on both surfaces.
Weight: 50 g.



Item: 191055

Weight with hooks, 20 g

Lead with hook on both ends.
Weight: 20 g



Item: 191085

Weight with hooks, 5 g

Lead with hook on both ends.
Weight: 5 g



Item: 191090

Weights with hooks, assortme

Weighing set with six pairs of different chrome-plated iron weights.

The set contains:

- 2 x 5 g



Item: 192010

Double cone with ramp

Contrary to what you might intuitively expect, the double cone seems to roll uphill when placed at the bottom of the ramp, but is this really the case?



Item: 192500

Friction Block, Roughness

Square wooden block with rubber, felt, sandpaper and wood surfaces. Equipped with hook.

Dimension : 60 x 60 x 300



Item: 192510

Friction Block, Area

To demonstrate friction with a body with the possibility of 2 different surfaces but with the same mass. Equipped with hook.



Item: 195003

Accessory set for air track

Extra accessory kit (spare part) for air cushion rail (195050). It contains the following parts:
4 pcs - Air cushion trolley



Item: 195050

Air track

Used to study smooth motion, smooth accelerated motion, Newton's 2. Newton's 2nd law, elastic and inelastic shock, etc.



Item: 110002

Cable, BNC to safety plugs

Adapter cable, BNC (male) to two safety connectors (male). Used, for example, to connect an experimental setup to an oscilloscope.



Item: 110090

Cable, 2 mm banana to safety

Transition connector: 1 set of wires (1 red and 1 black) with 2 mm banana plug on one end and 4 mm safety plug on the other.



Item: 111005

Adapter, BNC to safety socket

Transition piece from BNC to double safety plug.



Item: 113075

Cable holder for wall mountin

Safety cable holder, robust design that can hold at least 60 cables.
Consists of a 350 mm long aluminum rail with 18 plastic



Item: 113510

Copper wire, uninsulated, Ø0.

Roll of 100 g.



Item: 113520

Copper wire, uninsulated, Ø0.

Roll of 100 g.
Diameter: 0.5 mm.



Item: 113530

Copper wire, uninsulated, Ø1.0

Copper wire, uninsulated.
Diameter: 1 mm.
Quantity of copper on the roll:
14.3 m.



Item: 113540

Copper wire, uninsulated, Ø2

Copper wire, uninsulated.
Diameter: 2.00 mm. Length:
15 m.



Item: 106013

Lead for breadboard set, blue

This sturdy and flexible cable is designed for use with breadboards and experimenting with electronics. With a length of 10 cm and a conductor



Item: 106020

Lead for breadboard set, black

This sturdy and flexible cable is designed for use with breadboards and experimenting with electronics. With a length of 10 cm and a conductor



Item: 106220

Mini leads

Cords with insulated crocodile clips, also called "Japanese wires".
10 pcs. in assorted colors.
Length: 500 mm.



Item: 196010

Weight for cart, 50 g

Places symmetrically in pairs on the 196000 air cushion rail carriage.
Weight: 50 g.
Four of these weights are



Item: 196800

Adjustable end stop

Accessory for 195050: Can be attached to the air cushion rail to shorten the distance. Equipped with a 4 mm hole for connector pins.



Item: 197001

Hose for Air Blower

Spare part for air cushion rail fan.
(NOTE: When buying a new fan, hose included).



Item: 197570

SpeedGate

Speedgate is a stand-alone measuring device as its display eliminates the need for an external counter. It consists of a photocell with two parallel laser beams, and



Item: 197572

Cable, safety plug to modular,

The cable connects two safety connectors to a 6C6P modular connector.
Can be used to connect e.g. a free fall device (198010) to



Item: 198010

Free-Fall Apparatus

This experimental equipment can be used for experiments with the movement of objects, and it can thus be used to determine the gravitational acceleration g based on the



Item: 198011

Spheres Including Ping Pong

Spare part for 198010.
The drop object includes two $\varnothing 12$ mm gold-plated steel balls, two $\varnothing 16$ mm gold-plated steel balls and a table



Item: 198020

Newton's g - Ball

The ball contains a digital stopwatch that can display the time between 0.01-29.99 seconds. Hold down the key and the time is reset. Timing starts when you release the



Item: 198050

Gravity Weight

To demonstrate mass attraction between two bodies and determine the gravitational constant G . A highly sensitive string weight whose deflection can be



Item: 215510

Spiral spring, 32 mm

Spiral spring for testing elastic oscillations.
Spring constant: approx. 8.4 N/m
Diameter: 11 mm



Item: 215520

Spiral spring, 74 mm

Spiral spring for testing elastic oscillations.
Spring constant: approx. 3.2 N/m
Diameter: 11 mm



Item: 215530

Spiral spring, 115 mm

Spiral spring for testing elastic oscillations.
Spring constant: approx. 2.1 N/m
Diameter: 11 mm



Item: 215540

Spiral spring, 33 mm

Spiral spring for testing elastic oscillations.
Spring constant: 5.0 N/m.
Diameter: 31 mm.
Length: 33



Item: 215550

Spiral Spring, 155 mm

Spiral spring for testing elastic oscillations
Spring constant: approx. 4.7 N/m
Diameter: 27 mm



Item: 215562

Spiral spring, 1.8 m, Ø2 cm

Used for demonstrating transverse waves and for generating standing waves.
Length unloaded 1.8 m, diameter 2 cm.



Item: 215565

Spiral spring, 3 m

Wide and long spiral spring that can be clearly seen by the whole class during demonstration.
This spiral spring can be



Item: 215570

Slinky Spiral Spring

Used for demonstrating length fluctuations.
Length: 150 mm.
Diameter: 50 mm.
Extends to: 10 m.



Item: 215580

Set of springs

Spring set with 5 x springs of equal length and different stiffness. Each spring has a closed suspension at one end and a hook at the opposite end.



Item: 215585

Set of springs, 5 different

This spring set contains five coil springs suitable for e.g. Hooke's Law experiments.
Spring data:
Spring 1- Spring constant [



Item: 215600

Spring, Ø9.7 x 150 mm. k = 100

This spring can be used together with spring set 215585 to test Hook's Law.
Spring constant K = 100 N/m.
Dimensions:



Item: 217710

Weights with holder, brass

Slide weights with holder, in brass. The mass is embossed on the individual parts.
Diameter 25 mm.
1x50 g (bottom), 9x20 g, 1x10



Item: 218001

Spring set for Prytz oscillation

Spare springs for the 218000 Prytz oscillator.
The spring rates for the three types of springs used are respectively:



Item: 218500

Magnetic vibrator (original mo

This electromagnetic vibrator for generating mechanical vibrations is the original model developed by Frederiksen and produced in Denmark. The original model,



Item: 194510

Balloons, pack of 100.

Round balloons that can be used, among other things, for a hovercraft, order no. 194505.



Item: 069050

Vacuum pump manually-oper

This vacuum pump is made of PCE and weighs approximately 140 grams. The pump sucks 15 mL of air per pump and can create a negative pressure equivalent



Item: 069525

Vacuum pump, 2-stage

This 2-stage rotary vane vacuum pump with oil injection lubrication system has a robust construction and is easy to use and can be used for both laboratory and



Item: 105794

Safety adapter, 1000 V, blue

This safety adapter is equipped with a 4 mm pin that is placed in the traditional telephone socket and locked (expanded) by means of an Allen screw that is tightened



Item: 105797

Safety adapter, 400 V, yellow

This safety adapter is equipped with a 4 mm pin that is placed in the traditional telephone socket and locked (expanded) by means of an Allen screw that is tightened



Item: 077063

Bulb, 12V/10W with reflector

12 V / 10 W halogen with reflector. For the overhead light on the Primozoom II zoom magnifier (077061)



Item: 106012

Lead for breadboard set, yellow

This sturdy and flexible cable is designed for use with breadboards and experimenting with electronics. With a length of 10 cm and a conductor



Item: 109000

Uninsulated, alligator clips

Uninsulated crocodile clips with Ø 4 mm hole
Pack of 100 pcs.



Item: 109020

Insulated alligator clips, black

Insulated safety-type crocodile clip.
Color: black



Item: 109021

Insulated alligator clips, red

Insulated safety type crocodile clip.
Color : red



Item: 109510

Insulated Alligator Clips for 2

Insulated alligator clip for **2 mm** laboratory cables.
Color: black.
Note: This type does not fit the safety cables - use item



Item: 109511

Insulated Alligator Clips for 2

Insulated crocodile clip for 2 mm laboratory cables.
Color: red.

Note: This type does not fit the safety cables - use Safety



Item: 150000

Specific gravity cubes, without

This box contains six squares with the same volume of 1 cm³, which allows you to compare the density of different substances in relation to each other. The set



Item: 150010

Specific gravity blocks

This box contains three volume sizes in sets of 6 different materials. This allows you to compare the density of different materials in relation to each other.



Item: 151210

Mole Demonstration Kit

This Mole Set can be used to visualize the quantities moles and amount of matter.

The set contains four solids, three glasses for liquids and



Item: 199220

Curved ball track f. collisions i

For impact tests in 2 dimensions.

A simple but well-functioning device for demonstrating elastic and inelastic impact in



Item: 103090

Cable holder in steel

Cord holder for wall mounting. The holder has 13 slots and can hold approximately 60 cables.



Item: 103710

Dynamometer, 2.5 N, blue

Affordable force gauge, with color code. Can be used as a spring scale or force gauge, as both scales are printed on opposite sides of the force



Item: 103720

Dynamometer, 5 N, green

Affordable force gauge, with color code. Can be used as a spring scale or force gauge as both scales are printed on opposite sides of the force



Item: 103730

Dynamometer, 10 N, brown

Affordable force gauge, with color code. Can be used as a spring scale or force gauge as both scales are printed on opposite sides of the force gauge.



Item: 103740

Dynamometer, 20 N, red

Affordable force gauge with color code. Used as a spring scale or force gauge as both scales are printed on opposite sides of the force gauge. Can be 0-point



Item: 103750

Dynamometer, 50 N, yellow

Affordable force gauge, with color code. Can be used as a spring scale or force gauge as both scales are printed on opposite sides of the force gauge.



Item: 103800

Dynamometer, 0.1 N, silver

Precision force gauge made of clear acrylic. The upper part is made in different colors depending on the area. The force gauge is 0-point adjustable.



Item: 103810

Dynamometer, 0.2 N, beige

Precision force gauge (Newton meter) made of clear acrylic. The upper part is made in different colors depending on the area. The force gauge is 0-point



Item: 103820

Dynamometer, 1 N, yellow

Precision force gauge made of clear acrylic. The upper part is made in different colors depending on the area. The force gauge is 0-point adjustable.



Item: 103830

Dynamometer, 2 N, red

Precision force gauge made of clear acrylic. The upper part is made in different colors depending on the area. The force gauge is 0-point adjustable.



Item: 103840

Dynamometer, 5 N, blue

Precision force gauge made of clear acrylic. The upper part is made in different colors depending on the range. The force gauge is 0-point



Item: 103850

Dynamometer, 10 N, green

Precision force gauge made of clear acrylic. The upper part is made in different colors depending on the area. The force gauge is 0-point adjustable.



Item: 103860

Dynamometer, 20 N, purple

Precision force gauge made of clear acrylic. The upper part is made in different colors depending on the area. The force gauge is 0-point adjustable.



Item: 103870

Dynamometer, 50 N, orange

Precision force gauge made of clear acrylic. The upper part is made in different colors depending on the area. The force gauge is 0-point adjustable.



Item: 103880

Dynamometer, 100 N, gold

Precision force gauge made of clear acrylic. The upper part is made in different colors depending on the area. The force gauge is 0-point adjustable.



Item: 103900

Set of dynamometers in case,

Case set with nine different dynamometers, each with its own measuring range:
1 x 0.1 N, 0.2 N, 1 N, 2 N, 5 N, 10 N, 20 N, 50 N, 100 N.



Item: 105110

Cables with 2 mm plugs, 25 c

Highly flexible silicone insulated cables with \varnothing 2 mm connectors. Copper cross-section 0.50 mm², max 10 A. 30 V AC/ 60 V DC. Withstands temperatures up



Item: 105121

Cables with 2 mm plugs, 50 c

Highly flexible silicone insulated cables with \varnothing 2 mm connectors. Copper cross-section 0.50 mm², max 10 A. 30 V AC/ 60 V DC. Withstands temperatures up



Item: 105410

Safety cables, PVC, 25 cm, bla

Flexible PVC-insulated safety cable.
Max. 250 V / 10 A
Length: 25 cm
Color: black



Item: 105411

Safety cables, PVC, 25 cm, red

Flexible PVC-insulated safety cable. Max. 250 V/10 A.
Length: 25 cm
Color: red.



Item: 105412

Safety cables, PVC, 25 cm, yell

Flexible PVC-insulated safety cable max. 250 V / 10 A.
Length: 25 cm.
Color: Yellow.



Item: 105413

Safety cables, PVC, 25 cm, blu

Flexible PVC-insulated safety cable max. 250 V / 10 A.
Length: 25 cm.
Color: blue.



Item: 105420

Safety cables, PVC, 50 cm, bla

Flexible PVC-insulated safety cable. Max. 250 V/10 A.
Length: 50 cm
Color: black



Item: 105421

Safety cables, PVC, 50 cm, red

Flexible PVC-insulated safety cable.
Max. 250 V/10 A.
Length: 50 cm.
Color: red.



Item: 105422

Safety cables, PVC, 50 cm, yell

Flexible PVC-insulated safety cable max. 250 V / 10 A.
Length: 50 cm.
Color: Yellow.



Item: 105423

Safety cables, PVC, 50 cm, blu

Flexible PVC-insulated safety cable max. 250 V / 10 A.
Length: 50 cm.
Color: blue.



Item: 105440

Safety cables, PVC, 100 cm, bl

Flexible PVC-insulated safety cable max. 250 V / 10 A
Length: 100 cm
Color: black



Item: 105441

Safety cables, PVC, 100 cm, re

Flexible PVC-insulated safety cable max. 250 V / 10 A.
Length: 100 cm.
Color: red.



Item: 105443

Safety cables, PVC, 100 cm, bl

Flexible PVC-insulated safety cable max. 250 V / 10 A.
Length: 100 cm.
Color: blue.



Item: 105710

Safety cables, silicone, 25 cm,

Highly flexible silicone insulated safety cable with copper area 1.5 mm².
Max. 1000 V/25 A.
Working range: -60 - +180 °C.



Item: 105711

Safety cables, silicone, 25 cm,

Highly flexible silicone insulated safety cable with copper area 1.5 mm² . Max. 1000 V/25 A
Working range: -60 - +180 °C



Item: 105712

Safety cables, silicone, 25 cm,

Flexible silicone insulated safety cable with copper area 1.5 mm².
Max. 1000 V / 25 A.
Temperature range -60 -



Item: 105713

Safety cables, silicone, 25 cm,

Highly flexible silicone insulated safety cable with copper area 1.5 mm² max. 1000 V / 25 A, working range -60 - +180 °C.



Item: 105720

Safety cables, silicone, 50 cm,

Highly flexible silicone insulated safety cable with copper area 1.5 mm² max. 1000 V / 25 A, working range -60 - +180 °C Length : 50 cm
Color :



Item: 105721

Safety cables, silicone, 50 cm,

Highly flexible silicone insulated safety cable with copper area 1.5 mm² max. 1000 V / 25 A, working range -60 - +180 °C Length : 50 cm
Color :



Item: 105722

Safety cables, silicone, 50 cm,

Highly flexible silicone insulated safety cable with copper area 1.5 mm² max. 1000 V / 25 A, working range -60 - +180 °C.



Item: 105723

Safety cables, silicone, 50 cm,

Highly flexible silicone insulated safety cable with copper area 1.5 mm² max. 1000 V / 25 A, working range -60 - +180 °C.



Item: 105740

Safety cables, silicone, 100 cm

Highly flexible silicone insulated safety cable with copper area 1.5 mm² . Max. 1000 V/25 A. Working range: -60 - +180 °C.



Item: 105741

Safety cables, silicone, 100 cm

Highly flexible silicone insulated safety cable with copper area 1.5 mm² . Max. 1000 V/25 A. Working range -60 - +180 °C



Item: 105742

Safety cables, silicone, 100 cm

Highly flexible silicone insulated safety cable with copper area 1.5 mm² max. 1000 V / 25 A, working range -60 - +180 °C.



Item: 105750

Safety cables, silicone, 200 c

Highly flexible silicone insulated safety cable with copper area 1.5 mm² max. 1000 V / 25 A, working range -60 - +180 °C Length : 200 cm Color :



Item: 105751

Safety cables, silicone, 200 c

Highly flexible silicone insulated safety cable with copper area 1.5 mm² max. 1000 V / 25 A, working range -60 - +180 °C.



Item: 105753

Safety cables, silicone, 200 c

Highly flexible silicone insulated safety cable with copper area 1.5 mm² max. 1000 V / 25 A, working range -60 - +180 °C.



Item: 105785

Adapter, 2 mm banana to 4 m

In order to use cables with \varnothing 2 mm plugs, it is necessary to supply devices with \varnothing 4 mm sockets with an adapter with a \varnothing 2 mm hole. This 2 mm adapter is pressed into \varnothing 4



Item: 105790

Safety adapter, 1000 V, black

This safety adapter is equipped with a 4 mm pin that is inserted into the traditional telephone socket and locked (expanded) by means of an Allen screw that



Item: 105791

Safety adapter, 1000 V, red

This safety adapter is equipped with a 4 mm pin that is inserted into the traditional telephone socket and locked (expanded) by means of an Allen screw that



Item: 105792

Safety adapter, 400 V, black

This safety adapter is equipped with a 4 mm pin that is inserted into the traditional telephone socket and locked (expanded) by means of an Allen screw that



Item: 105793

Safety adapter, 400 V, red

This safety adapter is equipped with a 4 mm pin that is inserted into the traditional telephone socket and locked (expanded) by means of an Allen screw that



Item: 199710

Steel Ball, \varnothing 40 mm

Steel ball that can be used for motion and energy calculations, among other things.
Diameter: 40 mm



Item: 199720

Steel Ball, \varnothing 28 mm

Steel sphere that can be used for motion and energy calculations, among other things.
Diameter: 28 mm.



Item: 199730

Steel Ball, \varnothing 25 mm

Steel ball that can be used for motion and energy calculations, among other things.
Diameter: 25 mm



Item: 199740

Steel Ball, Ø20 mm

Steel ball that can be used for motion and energy calculations, among other things.

Diameter: 20 mm.



Item: 199750

Steel Ball, Ø18 mm

Steel ball that can be used for motion and energy calculations, among other things.

Diameter: 18 mm.



Item: 199760

Steel Ball, Ø16 mm

Steel ball that can be used for motion and energy calculations, among other things.

Diameter: 16 mm.



Item: 199770

Steel Ball, Ø12 mm

Steel ball that can be used for motion and energy calculations, among other things.

Diameter: 12 mm.



Item: 199780

Steel Ball, Ø10 mm

Steel ball that can be used for motion and energy calculations, among other things.

Diameter: 10 mm.



Item: 199785

Steel Ball, Ø6 mm

Steel ball that can be used for motion and energy calculations, among other things.

Diameter: 6 mm.



Item: 200500

Ticker tape Timer

Timer for measuring rectilinear motion. With the help of an electromagnet, a pin is moved so that dots are placed on a timer strip with an interval of 0.01 seconds,



Item: 200520

Tcker tape 18mm, 300m.

Roll of approx. 300 m timer strip for timer 200500.

For use with carbon discs [200530](#)



Item: 202500

Motor/generator with winding

The original motor/generator from Frederiksen. Universal motor for driving rotating devices such as strobe disks, color disks or raising solder (energy conversion)

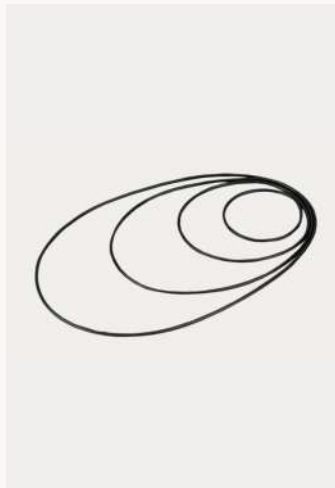

Item: 203700

Drive belts, set

The set consists of 4 flexible drive belts made of synthetic black rubber material. Belt lengths are approximately 240 mm, 390



Item: 203710

Drive belt, long

Drive belt made of 2 mm square elastic. Pack of 10 pcs. belt length: 400 mm.



Item: 207000

Circular motion apparatus

This device can be used to experiment with the rotation of a body. The rotation is created by an adjustable motor that sets a ball in motion via a chain. Based on



Item: 207010

Conical pendulum

In this conical pendulum, a weight moves in a smooth circular motion under the influence of the force of the string and gravity. The angle between these two forces is



Item: 208400

Force table

To demonstrate the parallelogram of forces (vector addition of forces). Three smooth-running pulleys can be mounted in any position along the edge of the



Item: 210821

Vehicles construction set

Build vehicles powered by hydropower and learn about green energy, the environment and physics. With the option to build 15 different models. Five of the



Item: 210870

Construction set, electric cars

Build different cars and machines that move using electric current - and learn about electricity and electrical circuits at the same time.



Item: 210925

Mouse traps, spring-loaded, w

"Old-fashioned" wooden clamshell mouse trap. Suitable for building mousetrap cars. See recipe in "Spanking the



Item: 210950

Electronic blocks, large

799 experiments with electricity and electronics. The modules are easily and elegantly assembled with push buttons. Includes



Item: 211005

Ninja balls

The concept of momentum transfer is convincingly demonstrated with this set. Drop the set from a low altitude and then observe



Item: 211520

Collision apparatus, small

Appliance for demonstrating Newton's 3rd law of motion, which states that action and reaction are equal and opposite. It is also suitable for demonstrating conservation



Item: 211600

Lemon clock

Make your own digital clock. The acid in the lemons absorbs electrons and the metal plates emit electrons, creating electrical energy.



Item: 212500

Rubber band powered plane,1

This small rubber band-powered model airplane is an exciting way to introduce students to the principles of flight and aviation. This compact airplane is equipped



Item: 195540

Holder with hook and plug

Used with 196300 pull weights and some bear wire (116500) for smooth accelerated movement on an air cushion rail (and similar experiments).

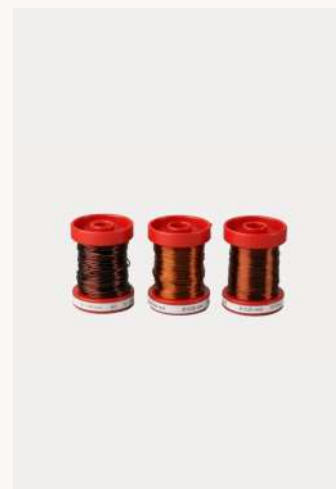

Item: 114010

Copper wire, insulated, Ø0.25

Copper wire, roll of 100 g, insulated. Diameter: 0.25 mm. Length: 235 m.



Item: 114020

Copper wire, insulated, Ø0.50

100g roll Diameter: 0.50 mm
Length: 59 m

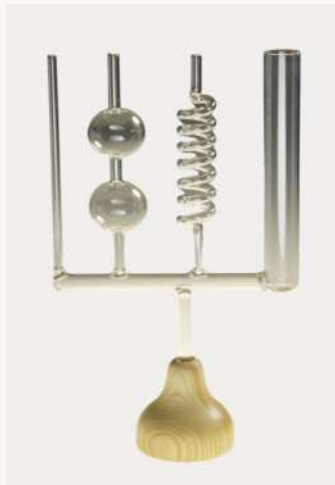

Item: 163000

Connected pipes on wooden

This device is used to study how connected vessels are affected by pressure and density. The liquid surface will be at the same height regardless of the fact that the



Item: 164010

Archimedes cylinder set

To demonstrate Archimedes' Law. Consists of a plastic weight with an eye and a transparent plastic container with two nylon loops: the upper one for hanging on a



Item: 164520

Overflow vessel, aluminium

A body is lowered into the overflow vessel and the displaced liquid flows out through an outlet pipe and can be collected in a measuring glass. This can be



Item: 165000

Hydraulic Press, Model

This hydraulic press model can be used to investigate the relationship between pressure and volume.

The set consists of two



Item: 166000

Cartesian devil

For fluid pressure demonstration.
Hollow glass figure.
Height: approx. 45 mm.



Item: 173200

Metal can for vacuum experim

For demonstrating pressure phenomena.
Supplied with plug and spigot.
Height: 225 mm.
Diameter: 92 mm.



Item: 173515

Magdeburg hemispheres, rub

Student edition to demonstrate the effects of external air pressure.
Press the two cups together and try to pull them apart



Item: 173600

Hand boiler

When you wrap your hand around the bottom sphere of the love barometer, the heat from your hand will cause the air in the love barometer to expand and the liquid (the



Item: 106021

Lead for breadboard set, red

This sturdy and flexible cable is designed for use with breadboards and experimenting with electronics. With a length of 10 cm and a conductor



Item: 195550

Flag with plug, 100 mm

Used as an aperture for photocell unit for time measurements on the air cushion rail. Weight 10 g.



Item: 429330

LCR-circuit

Used for experiments with oscillation circuits and filters. Components are carefully matched to best illuminate different characteristics. For



Item: 429350

Relay on base

5 V relay with one switching contact. The switch can withstand up to 8 A. The relay coil is equipped with fuse diodes so that the



Item: 429360

Holder for fuse wire

Used in circuits where you want to demonstrate the operation of a fuse. It is used together with fuse wire 410000 that is pressed between the fuse holder's



Item: 429370

LED on base, red

A red LED with series resistor mounted on a solid base plate between a red (plus) and a black (minus) safety bushing.



Item: 429380

Rectifier on base

Silicon diode, mounted on a solid base plate with safety bushings. Loadable up to 6 A. Base plate: 120 x 90 mm.



Item: 429390

Bridge rectifier on base

Bridged silicon rectifier, mounted on a solid base plate with safety bushings.



Item: 429400

Solar Cell on Base

Single solar cell, mounted on a solid base plate with safety bushings. Delivers approx. 0.5 V / 800 mA in full sun. Base plate: 120 x 90 mm



Item: 429410

Magnet holder on base

Holder for two bar magnets. Guides the top magnet to hover above the bottom magnet. (The magnetic poles must be reversed equally.)



Item: 429500

Voltmeter, digital, DC

A student-friendly digital DC voltmeter with a 3-digit LCD display. Connects with one red and one black safety socket (red



Item: 429600

Ammeter, Digital, 2 A, DC

A student-friendly digital DC ammeter with a 3½ digit LCD display. Connects to one red and one black safety socket (red is



Item: 429610

Ammeter, digital, 20 A, DC

A student-friendly digital DC ammeter with a 3½ digit LCD display. This school-friendly device offers precise current measurement with its 3½ digit LCD display. With an



Item: 429700

Power meter, 90 W DC

Digital DC meter that measures voltage, current, power and energy. Created with schools in mind, this instrument is ideal for educational



Item: 514140

Radiation holder with rod for p

Source holder with rod for plates.



Item: 116000

Iron wire, Ø0.50 mm

Iron wire (Steel wire)
Diameter: 0.50 mm

Relevant experiments:
[Resistance in metal wire](#)



Item: 116500

Extra strong thread

Extra strong sewing thread, 100% polyester. Roll with approx. 150 m. Good for hanging pendulums and weights.



Item: 116600

Cord, braided

Very strong, thin, braided Dacron line with countless applications in physics. The line is many times stronger than bear wire (



Item: 116800

Fishing line, Ø0.4 mm, 100 m

Fishing line Ø 0.4 mm, reel with 100 m.



Item: 283090

Spectral Lamp Holder with Scr

This spectral lamp housing is used for spectral lamps with E-27 screw base. The spectral lamp housing is equipped with a special 3-pin connector that must be



Item: 142070

Laser pointer, red

Handheld battery-powered diode laser in pencil format that can be used for optics experiments, e.g. to study the refraction of light in different



Item: 142080

Laser pointer, green

Handheld battery-powered diode laser in pencil format that can be used for optics experiments, for example to study the refraction of light in different



Item: 142095

Laser pointer, violet

Handheld battery-powered diode laser in pencil format that can be used for optics experiments, e.g. to study the refraction of light in different



Item: 142100

Optical fibre model

This light guide consists of a bent acrylic rod with a length of 500 mm and a diameter of 10 mm. The light guide has 2 turns with a diameter of approximately 50 mm. The



Item: 97970100

Protective cover for 370000

Protects your van de Graaff generator from dust and dirt during storage.



Item: 069060

Manually-operated vacuum p

Hand-operated vacuum pump with piston and hose nozzle Ø9-13 mm with non-return valve.



Item: 250515

Loudspeaker on rod 3 W

Used with function generator 250350 or 250310 to produce sound from a point source. With two speakers you can demonstrate interference.



Item: 344010

Gaussian Gun

This Gauss cannon can be used for experiments in dynamics to investigate the conversion of potential energy into kinetic energy.



Item: 429800

Secret Boxes, basic

Eight different hidden circuits with switches and light bulbs. Each box is connected to a 4.5V battery or power supply (not included). The circuits are explored by pressing



Item: 117510

Platinum wire, Ø0.25 mm

Platinum thread. Please note that the price is per cm. Diameter: 0.25 mm.



Item: 117630

Silver Wire, Ø1.00 mm

Silver wire 99.9% pure with a diameter of 1.0 mm and a length of 100 cm.



Item: 173510

Magdeburg Hemisphere, Blac

To demonstrate the effect of external air pressure on a vacuum.

A connecting hose for a vacuum pump (e.g. 069060)



Item: 180700

Gas law apparatus

The apparatus can be used to prove the three historically important special cases of the ideal gas equation:

Boyle-Mariotte's law: $p \cdot V =$



Item: 180900

Cloud Bottle

This Cloud bottle creates a cloud by adding a small amount of water to the bottle and then pressurizing the bottle.



Item: 452960

Renewable Energy Kit (small)

Explore the potential of renewable energy with the Eco Racer - Wind.

Use wind power to produce electrical energy for use in



Item: 670174

Wheel pack of 25 pcs., 40 mm

Wheel package with 25 x 40 mm wheels.

Axis hole is 4 mm.

Wheel width is 5 mm.



Item: 212110

Raket, Rokit with bottle

In an experiment where you stand on a skateboard and throw a ball, there will be a movement in the opposite direction, just as shown in Newton's 3rd law of action



Item: 038000

Valve rubber

Valve rubber.

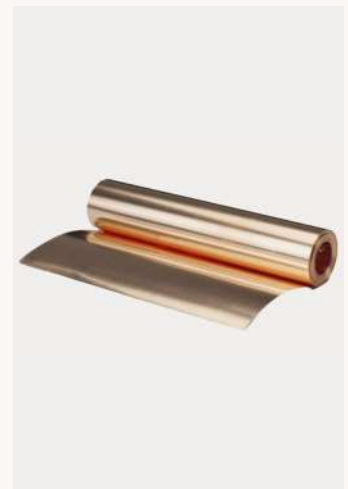

Item: 118510

Copper foil

Roll with copper foil
Dimensions: 0.1 x 200 x 1480 mm
Weight: 500 g



Item: 274050

Calorimeter with isolating styr

This calorimeter can for example be used together with 274010 for verification of Joule's law and 274020 for the study of energy conservation.



Item: 114030

Copper wire, insulated, Ø1.00

Roll of 100 g. Diameter: 1.00 mm Length: 15 m



Item: 115510

Kanthal wire, Ø0.25 mm

One roll contains 100g of edging wire, which corresponds to approx. 280 m. Ø 0.25 mm. The resistivity is = 1.45×10^{-6} (



Item: 115520

Kanthal wire, Ø0.50 mm

One roll contains 100 g of edging wire, which corresponds to approximately 71 m. Diameter: 0.5 mm. Resistivity = 1.45×10^{-6} (ohms



Item: 115530

Kanthal wire, Ø1.00 mm

One roll contains 100 g of edging wire, which corresponds to approximately 18 m. The resistivity is = 1.45×10^{-6} (



Item: 105755

Safety Cables, Silicone, 150 c

Black safety cable for 5000 V. The test leads are equipped with a connector with a 4 mm safety banana plug at each end.



Item: 151015

Specific gravity weights, same

Set consisting of brass, iron and aluminum cylinder with hook. Dimension: 32 x 20mm diameter.

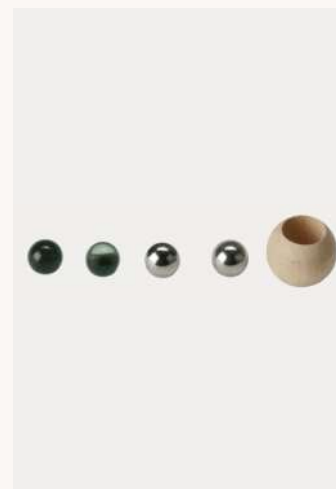

Item: 199225

Sparepart for 199220, 5 x Balls

The set consists of two steel balls 12 mm, one glass ball 12 mm, and one hollow wooden



Item: 792009

Floating globe

The globe, which has a diameter of 20 cm, is kept floating by an electromagnet. This means that friction is very low and the globe will rotate at a steady speed for



Item: 210953

Switch, spare part for 210950

Spare part
Bag of 10 switches for our electronics kits
The chip has number 15.



Item: 210954

Red lead, spare part for 21095

Red LED, spare part for 210950

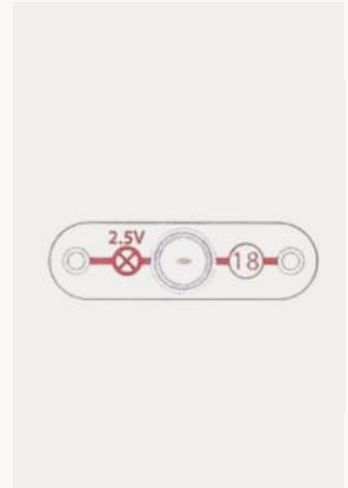

Item: 210955

Socket, spare part for 210950

Fitting, spare part for 210950



Item: 210956

Battery holder, spare part for 2

Battery holder, spare part for 210950



Item: 195210

Electric launcher

Accessory for the air cushion bench (195050)
Together with the switch box (198515), the firing mechanism will enable a



Item: 201710

Speed of Light

This device, in conjunction with an oscilloscope, makes it possible to measure the time it takes for a short flash of light to travel a distance of a few meters. The experiment



Item: 438105

Electrostatic Material

The Electrostatic Materials Kit is an essential part of any science classroom. The kit contains various materials that can be used to investigate static electricity.



Item: 180520

Vacuum Gauge

A simple model to demonstrate the relationship between volume and pressure at constant temperature. The apparatus consists of a graduated



Item: 362540

Power Supply, 30 V, 5 A, DC

An affordable alternative when you need a stable DC power supply that can deliver up to 30 V / 5 A. The digital display shows both current and voltage simultaneously.



Item: 429000

Lamp holder E10, 2 connectors

E10 socket (for flashlight bulbs) mounted on a solid base plate with 2 safety bushings. The base is equipped with



Item: 429020

Lamp Holder, 3 x E10, 6 Conne

Three E10 sockets (for flashlight bulbs) mounted on a solid base plate with six safety bushings. The three bulbs can be connected in series, parallel or a



Item: 429030

Lamp holder E27, 2 safety soc

E27 socket (recommended for 12 V incandescent bulb) mounted on a solid base plate with 2 safety bushings. The base is equipped with



Item: 429040

Pushbutton on base

Pressure switch (ring push). Closes contact as long as pressure is applied. The switch is mounted on a solid base plate with safety



Item: 429050

On/off switch on base, single-

Single-pole rocker switch with on/off marking. The switch is mounted on a solid base plate with safety bushings.



Item: 429060

On/off switch on base, double

The two-pole rocker switch with markings for on and off. The switch is mounted on a solid base plate with safety bushings. A stable solution



Item: 429070

Telegraph key

Push button (ring button), shaped like an old-fashioned telegraph key.

The switch is mounted on a solid base plate with safety



Item: 429080

Knife switch on base, one-way

Single-pole switch, designed as a knife switch.

The switch is mounted on a solid base plate with safety bushings.



Item: 429090

Knife switch on base, two-way

Single pole switch, designed as a blade switch.

The switch is mounted on a solid base plate with safety bushings.



Item: 429100

Motor on base, 2 - 6 V

2-6 V DC electric motor.

The motor can also be used as a generator. To power a 1.5 V, 90 mA incandescent lamp, a speed of



Item: 429110

Connected motors on base

Two identical electric motors to demonstrate energy conversion between electrical and mechanical energy. One motor drives the other around to act as a



Item: 429120

Buzzer on Base, 2 - 12 V

The buzzer is mounted on a solid base plate with safety bushings.

Base plate: 120 x 90 mm.



Item: 429130

Resistor holder

Up to four resistors (or other components) can be mounted in terminal blocks that are individually connected to safety bushings. Used when unmounted components need



Item: 429140

Resistor on Base, 1 Ω, 50 W, 5

50 W power resistor. Wire wound resistor with 5% tolerance.

The resistor is mounted on a solid base plate with safety



Item: 429150

Resistor on Base, 5 Ω, 50 W, 5

50 W power resistor. Wire wound resistor with 5% tolerance.

The resistor is mounted on a solid base plate with safety



Item: 429160

Resistor on Base, 10 Ω, 50 W, 5

50 W power resistor. Wire wound resistor with 5% tolerance.

The resistor is mounted on a robust base with safety



Item: 429170

Resistor on base, 50 Ω, 10 W, 1

50 ohm power resistor of 10 W. Precision wire wound resistor with 1% tolerance.

The resistor is mounted on a solid base plate with safety



Item: 429180

Resistor on Base, 100 Ω, 10 W, 1

100 ohm power resistor of 10 W. Precision wire wound resistor with 1% tolerance.

The resistor is mounted on a solid base plate with safety



Item: 429190

Resistor on Base, 150 Ω, 10 W, 1

10 W 150 Ω power resistor, precision wire wound resistor with 1% tolerance.

The resistor is mounted on a solid base plate with safety



Item: 429200

Resistor on Base, 470 Ω, 10 W, 1

10 W power resistor with 470 Ω. Precision wire wound resistor with 1% tolerance.

The resistor is mounted on a solid base plate with safety



Item: 429210

Resistor on Base, 1 kΩ, 10 W, 1

10 W power resistor. Precision wire wound resistor with only 1% tolerance.

The resistor is mounted on a solid base plate with safety



Item: 429230

Resistor on Base, 4,7 kΩ, 10 W, 1

10 W power resistor. Precision wire wound resistor with 1% tolerance.

The resistor is mounted on a solid base plate with safety



Item: 429250

Resistors on Base, 2 x 470 Ω, 5

Two resistors, 470 Ω, for simulating the resistance in long wires. Each resistor is connected to two safety bushings.



Item: 429260

Resistors on Base, 20, 50, 100, 5

Four precision resistors mounted with safety bushings. The resistors can be combined in series and parallel connection with standard safety cables in



Item: 429270

NTC resistor on base

The resistance of an NTC resistor decreases with temperature. NTC resistors can therefore be used for temperature measurements. Another application is "soft



Item: 429280

LDR resistor on base

Photosensitive resistor, mounted on a solid base plate with safety bushings. A stable solution that won't tip over or slide around in use.



Item: 429290

NPN transistor on base

Transistor base, connected to safety bushings, mounted on a solid base plate. Ten BC547 transistors included.



Item: 429300

Capacitor on Base, 1 F

A "SuperCap" capacitor mounted on a solid base plate with safety bushings. Illustrates electrostatic energy storage (well over 30 J).



Item: 429310

Capacitor on Base, 15000 uF

Large electrolytic capacitor, mounted on a solid base plate with safety bushings. Can be used in charging and discharging experiments,



Item: 429320

Potentiometer on Base, 100 Ω

Wire wound power potentiometer (5 W). The potentiometer is mounted on a solid base with three 4 mm safety feet. Excellent as a variable load resistor, e.g. for



Item: 487510

Thermogenerator with motor

Consists of a Peltier element constructed from 127 series-connected rods of a semiconductor material mounted on a heat sink. The Peltier element can be



Item: 488505

Solar Cell Array

This solar panel consists of four single cells that can be used individually or in various series and parallel connections (see picture). The connections are made



Item: 488540

Solar Panel, 10 W, 12 V, Monoc

This solar panel has 24 series-connected monocrystalline cells. In full sun, the panel can deliver a total maximum power output of 10 W (12 V / 0.83 A)



Item: 500550

Renewable energy monitor

With this data logger, students can perform a variety of voltage, current, power, energy and resistance measurements, as well as rotational speeds on



Item: NL122037

Lens, +150 mm

Lens, +150 mm
This lens is made of high-quality glass. The focal point is 15 cm from the belly of the lens.



Item: NL122142

Optical Lens, Convex / Conve

Double ball disc lens, focal point +110 mm, length 80 mm, plexiglass, 15 mm high, frosted underside
Suitable for geometric



Item: 222010

Tuning fork for demonstration

The demonstration tuning fork whose oscillation is so slow that the tone cannot be heard (around 5.4 Hz). On the other hand, it is easy to follow its movements with your



Item: EM-6723

500 Turn Field Coil

Flat, circular coil with 500 turns. Used e.g. for detecting Ampere's law – see EM-6720. Supplied with two adapters for safety plugs (permanently



Item: 339530

Magnetic Field Plates, Four Pa

Four plates with small iron rods for demonstrating magnetic field lines, without the use of loose iron filings. By placing the plates at an



Item: 452941

Spareparts - incl. Fuel cell for

Spare parts package for renewable energy kit [452940](#) and fuel kit 452998.



Item: 452942

Sparepart - Electrolysis Unit fo

Spare part for 452940, 452980 and 452990.



Item: NL114034

Digital multimeter

Digital multimeter Equipped with 3 1/2 digit 27 mm LCD display with a maximum reading of 2000 counts.



Item: NL114046

Digital universal multimeter, m

This digital multimeter is suitable for practical use and protected against overload.



Item: 426500

Light Bulb, 12V, 60 W, E27

12 V incandescent bulb, 60 W - can be used with 429030 for low voltage testing.



Item: 461520

Arc Discharge Rods with Safet

To demonstrate high voltage and the upward travel of the high-voltage arc due to heat. For safety reasons, the splitter bars are built into insulating and protective



Item: NL112331

Prism, equilateral, 30 x 30 x 5

The prisms are made of crown glass and can be placed on the prism table NL112330. Shape: equilateral Dimensions: 30 x 30 x 50 mm



Item: NL112335

Prism, rectangular, perspex, 4

Rectangular model prism, dimensions 30 x 30 x 45 mm. Crystal clear finish.



Item: NL119216

Rubens' tube

This Rubens tube can be used to demonstrate the standing waves shown in a flame pattern, as a reflection of the sound pressure from a tone generator, e.g.

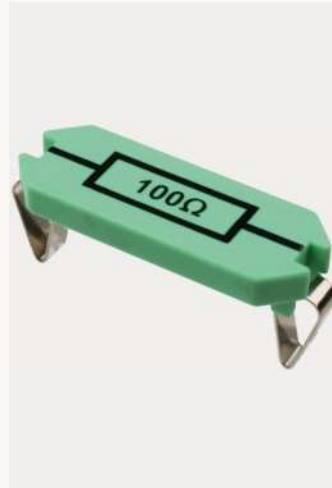

Item: NL115233

Resistor, 100 Ω , 1 W, 5%

Locktronics LK4002 switching element with resistor, 100 Ohm, 1W, 5%



Item: 503725

Pump replacement kit for 503

This kit includes a new pump for collector model 503720.



Item: 513575

GM-sensor with Jack plug, so

Geiger-Müller sensor with built-in high-voltage power supply suitable for use in many of the traditional experiments with



Item: NL122041

Lens, -200 mm

Optically ground crown glass lens, 50 mm ϕ
Lens, $f = -200$ mm.



Item: NL122150

Sliders for light source, pulley

Rider with hole and set screws, for light source NL122147.



Item: NL122151

Slider for lens holder

Rider with hole for lens holder NL122168.
Fits rail NL118521 and part of kit NL112110.



Item: 708011

Soldering iron with Schuko co

Supplied with Longlife pointed bit 51, chamfered 3-4 mm, the soldering iron is equipped with a Danish Schuko earth plug.



Item: 97031110

Spare Lamp for 287100

7W UVA replacement bulbs for UV lamp 287100.



Item: NL122166

Lens, f = -100 mm, in Holder

Lens with focal point $f = -100$ mm in lens holder and rider mount. Fits rider NL122151. The lens diameter is 50 mm.



Item: NL122167

Lens, f = -200 mm, in Holder

Lens with focal point $f = -200$ mm in lens holder and on rider mount. Lens diameter is 50 mm.



Item: NL114048

Digital universal multimeter, m

This digital multimeter is suitable for practical use and protected against overload. The included test leads are equipped with safety plugs.



Item: NL114492

Wimshurst electrostatic gener

A Wimshurst machine is a high-voltage electrostatic generator in which a handle is used to rotate two insulated disks with metal plates in opposite directions, while the



Item: NL114745

Battery holder for 3 x batteries

Battery holder for 3 x D batteries LR20 (R20) with 4 safety sockets, i.e. sockets for 1, 2 or 3 batteries in series or 2 in parallel connection.



Item: 500562

LED Module

Accessory for wind turbine 500560. 4 mm safety cables can be used.



Item: 489026

Holder for Håndpyranometer

Hand pyranometer holder - the product is used as an aid to set the Pyranometer 489025 at different "sun angles" 0 - 90 degrees.



Item: 187515

Anemometer, electronic

Handheld anemometer with temperature sensor. The instrument is equipped with a solid soft plastic protective cover that protects the anemometer from wind and

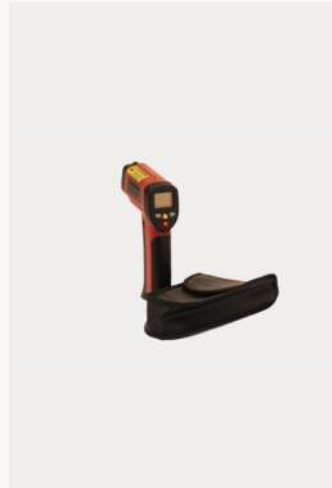

Item: 260808

Thermometer 650 °C, electron

An infrared thermometer can be used to measure surface temperature by pointing the thermometer at an object or surface.



Item: NL122124

Optical Lens, Flat / Concave, F

Disc lens flat-cavity, focal point -80 mm, length 60 mm, plexiglass, 15 mm high, frosted underside.



Item: NL122125

Optical Lens, Convex / Conve

Slicing lens double ball, focal point +40 mm, length 40 mm, plexiglass, 15 mm high, frosted underside.



Item: 178020

Air pump plate, Basic

Used with the Air Pump Bell (178510) to demonstrate the physical state of an object/material when a vacuum is created. The pump plate connects to a



Item: 174500

Wind Tunnel

High quality wind tunnel from Leybold. The item is a made-to-order item and a delivery time of 12 - 16 weeks can be expected.



Item: 174505

Measurement Trolley for Wind

Accessory kit for wind tunnel 174500. Delivery time 12 - 16 weeks.



Item: NL122168

Lens holder for mounting on sl

Spare part for optics kit NL112110.



Item: NL111020

Number balance, two-armed b

Plastic math balance with 2 straight arms. Contains 20 x 10 g weights. Dimensions: 655 x 210 mm.



Item: 213610

Bicycle wheel gyro

Suitable for demonstration and verification of conservation of angular momentum. The system's moment of inertia is adapted to the rotating platform with



Item: NL112322

Lens in Holder, -200 mm

The lenses are fixed in the black plastic fittings. The focal length is indicated on the frame. The size of the disc is 130 mm ø. The stem



Item: NL115228

Resistor, 10 Ω, 1 W, 5 %

Locktronics LK4025 switching element with resistor, 10 Ohm, 1W, 5%



Item: NL122147

LED light source for optic use

Light source with 12 V DC LED lamp in a black light metal box and with connection of 4 mm safety plug. The lamp housing is only slightly heated due to the



Item: 223510

Tuning Fork, Set

Voice fork set with 8 x different frequencies: 256, 288, 320, 341.3, 384, 426.6, 480, 512



Item: 250520

Bluetooth, Mini-Loudspeaker,

Bluetooth mini speaker with a range of 10 m. The speaker can be used for experiments on sound propagation in vacuum, for example in an experiment with the 178020



Item: 271000

Radiation cans

To demonstrate the importance of color in heating and cooling. Fill with cold water and place near a strong light source,

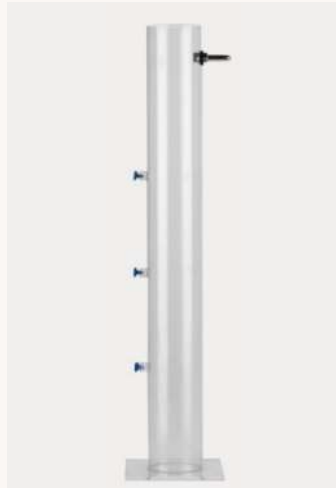

Item: 161510

Pressure of the Liquid Column

This liquid container can be used for experiments aimed at demonstrating the pressure difference in a column of liquid.



Item: NL122128

Optical lens, semi-cylindrical,

The lens is made of Plexiglas. 60 mm wide and 15 mm high.



Item: 174510

Aerodynamics Accessories 2

Accessory for wind tunnel 174500. The item is a made-to-order item and 12 - 16 weeks delivery is expected. **Specifications:**



Item: 174520

Sector Dynamometer, 0.65 N

Accessories for wind tunnel 174500. Delivery time 12 - 16 weeks.



Item: 178800

Air pressure and vacuum kit

This air pressure and vacuum kit is used to demonstrate the effect of air pressure on the boiling point of water, the size of a balloon in a vacuum and the holding force of a suction



Item: 210970

Electronic blocks, medium

Electronics kit in the modular kit series to start learning electrical circuits. Contains everything you need and is easily assembled with



Item: 251570

Microphone probe without ca

This probe microphone can be used to measure sound pressure, especially in hard-to-reach places. The microphone unit is placed at the end of a $\varnothing 8 \times 950$ mm

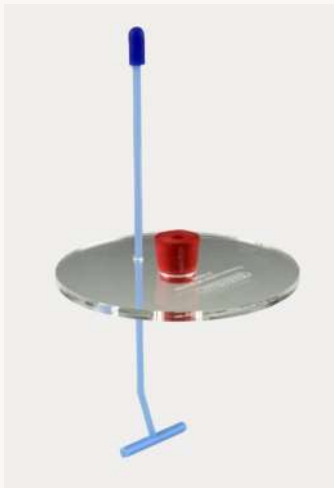

Item: 274020

Lid for Calorimeter

This lid is used with the 274050 calorimeter and can be used for e.g. energy conservation experiments. Supplied with a plug hole to



Item: 285570

Spectral tube holder with pow

Homemade spectral tube holder for use with the well-known thin spectral tubes. With its spring function, it is quite easy to use as it



Item: 287120

UV Flashlight, 395 - 400 nm

This affordable UV flashlight with 9 UV LEDs is suitable for experiments with UV beads and other fluorescence experiments.



Item: 293505

Socket for 293500 light box

This socket is included in light box [293500](#) and is used to replace light boxes purchased with a bayonet socket as the original bulb has been discontinued. The

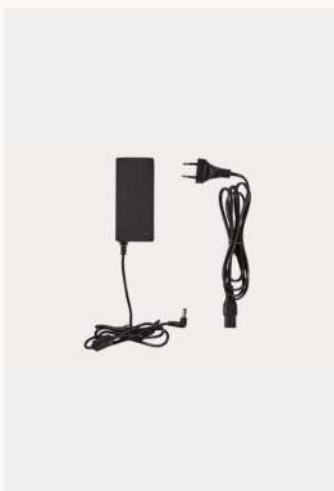

Item: 293520

Power supply for light box 293

As an alternative to the regular power supply, this mains adapter can be used for the 293500 and 293600 light boxes. Can also be used for the 280030 student



Item: 293610

Halogen bulb for 293600 (1 pc)

Spare bulb for optics kit 293600 (1 pack)
Specifications: 12 V, 20 W.



Item: 300020

Semi Circular Refraction Dish

This open prism can be used in optics experiments to identify the refractive index of different liquids, as the exit angle relative to the vertical line of the light source can be



Item: 361700

Power Supply, 12 V, AC/DC, 3

The power supply delivers a stabilized DC voltage that is infinitely adjustable between 0 and 12 V. The output voltage is shown on a digital display.



Item: NL122177

Plate with 3 and 5 slits

Plate with 3 and 5 slots



Item: NL122182

Prism table for mounting on sli

Prism board for mounting on rider NL122151
Diameter prism board 60 mm
Diameter stand rod 10 mm
Height 43 mm



Item: 170510

Pelton Turbine, with Safety Plu

This Pelton Turbine provides an opportunity to investigate how running water can be used to produce electricity to light an incandescent lamp or LED.



Item: 216600

Pendulum bob, wooden ball wi

5.6 g oak wood ball with brass hook.
The hook weighs 0.78 g.
Diameter: 24 mm.



Item: 216610

Pendulum bob, steel ball with

70 g steel ball with brass hook.
The hook weighs 0.78 g.



Item: NL111301

Buffer spring with pin

Shock spring with 4 mm pin.
Made of stainless steel spring band, for mounting on measuring trolley NL111300.



Item: 351608

Button cell battery, V13GA/LR

Battery pack with 10 button cell alkaline batteries
1.5 V / 125 mAh



Item: NL112328

Iris diaphragm in holder

Iris membrane in holder



Item: NL115230

Resistor, 47 Ω, 1/2 W, 5%

Locktronics LK4065 switching element with resistor, 47 Ohm, 0.5W, 5%



Item: NL115231

Resistor, 50 Ω, 1/4 W, 2%

Locktronics LK8980 switching element with resistor, 50 Ohm, 0.25 W, 2%



Item: 598115

Primary Optics Kit

With this new experiment kit, students can explore a range of light phenomena experienced in everyday life. Included is a guide in English



Item: 174010

Baroscope

To study the mass of air: A Dasymer is used in an experiment where it is placed in a vacuum in a pump bell. As the air is pumped out of



Item: 260823

Thermal Camera, FLIR C3-X, CI

A great new thermal camera for visualizing thermal radiation. The thermal camera allows students to study heat and temperature in an interactive and exciting



Item: 200270

Universal Timer

The Frederiksen Scientific Universal Counter is designed for timing and counting using a wide range of equipment from Frederiksen Scientific and



Item: 200285

Student Timer

Frederiksen Scientifics elektriske stopur er den ideelle enhed til tidtagning i naturfaglige undervisningsmiljøer. Den er kompatibel med en



Item: 199015

Falling bodies apparatus

Karisekanon - Den kan anvendes til at vise at en kastebevægelse kan opfattes som sammensat af frit fald og en horisontal bevægelse.



Item: 274520

Immersion heater with safety

Used with a thermos cup to study Joule's law. The lid has a center hole for a thermometer. The depth heater has a 2.2 ohm power resistor that acts as a heater.



Item: 463510

E-core, laminated

For demonstration of 3-phase transformer. Fits coils no. 462510-40. Set with both upper and lower core on base.



Item: 330000

Lodestone

In nature, magnets can be found in the form of magnet ironstone, a ferrous rock that has become magnetic due to the Earth's magnetic field.



Item: 330100

Hovering magnets, Multicolour

Six magnets on plastic stick with base. A simple and colorful way to demonstrate the strength of magnets. With the 6 magnets



Item: 330110

Hovering magnets, Two-colour

Three two-colored magnets on plastic stick with base. A simple and colorful way to demonstrate the power of magnets.



Item: 330500

Bar magnets, cylindrical

Set of 2 AlNiCo round bar magnets with anchors and colored poles. Size: Ø 11 x 170 mm.



Item: 330510

Bar magnets, square section

Set of 2 square bar magnets with dimensions 10 x 10 x 100 mm. These magnets are made of AlNiCo material that withstands high



Item: 338540

Iron nails, 130 mm

Iron nails that can be used for magnetic testing, among other things. Length: 130 mm. Number: 50 pcs.



Item: 343500

Magnaprobe

Used to examine magnetic fields between like and unlike poles, the direction of magnetic fields around a wire or coil, the magnitude of magnetic fields produced by



Item: 344020

Magnet gun

The spectacular and surprising effect of the cannon makes everyone ask what happened, and once the question is in the air, more experimentation with the



Item: 350555

Battery, 3R12U, 4.5 V

Type: Tungsten. Voltage: 4.5 V. Code: 3R120. Dimension: 62 x 21 x 65 mm.



Item: 351004

Battery, LR03, 1.5 V, AAA

Standard 1.5 V battery. Type: Alkaline. Voltage: 1.5 V. Code: LR03 (AAA). Dimension:



Item: 351005

Battery, LR6, 1.5 V, AA

Standard 1.5 V battery. Type: Alkaline. Voltage: 1.5 V. Code: LR6 (AA). Dimension:



Item: 382600

Test leads for multimeter

One red and one black test lead with angled safety plugs on one end and a shiny metal tip on the other.



Item: 386135

Multimeter, DMM 135

Affordable 3 3/4 digit autoranging multimeter. A handy multimeter for less demanding measuring exercises.



Item: 386215

Multimeter, model 125

3 3/4-digit autoranging multimeter. Measures voltage, current and resistance. Equipped with an analog bar graph at the bottom of the display for a



Item: 386225

Multimeter, model 120

Easy-to-use digital multimeter at a low price. With only two connection sockets, the possibility of misoperation is minimal.



Item: 386231

Multimeter, DMM-8062

3 3/4-Digit Autoranging Multimeter
A modern instrument that can also measure capacitance, frequency, and temperature.



Item: 400150

Oscilloscope, digital, 60 MHz

State-of-the-art and flexible lightweight oscilloscope. In addition to traditional applications, this oscilloscope is well suited for capturing single events; a short burst in



Item: 407545

KWH-Meter, ST2300

Energy meter for measuring grid consumption from the socket. With the energy meter, the energy consumption of individual appliances can be

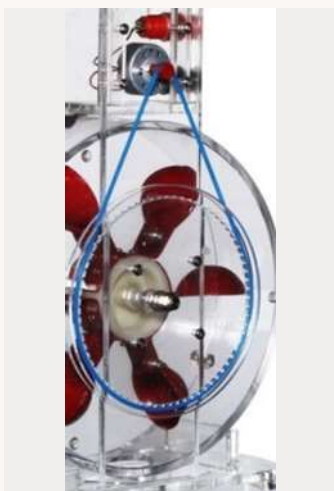

Item: 170512

Sparepart - drive belt for Pelto

Spare part for Pelton turbine 170510.



Item: 452852

Fuel cell, dismantlable

Separable hydrogen fuel cell where students can see how a fuel cell is constructed and examine the individual parts. The separable fuel cell can be used as a single cell or as



Item: 452870

Fuel cell set, Dr FuelCell

Complete energy kit containing different sources for producing green energy. The kit includes a fuel cell, a solar cell to power the



Item: 452875

Load and measuring box

Suitable for experiments with solar cells, fuel cells and other DC voltage sources. Not for use with wind turbines or other supplies that emit pulsating direct current. The

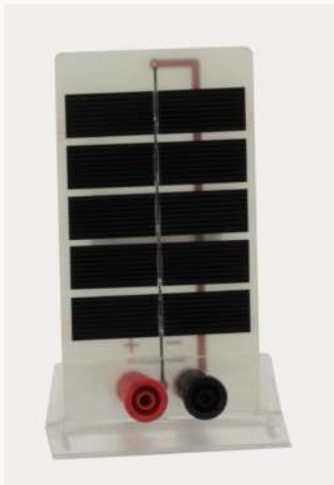

Item: 452876

Solar Cell for Fuel Cell Car

This solar cell can be used as a spare (or additional) part for DrFuelCell fuel cell car 452891/92 and Fuel cell kit Dr FuelCell



Item: 452882

DrFuelCell, Professional, Com

This complete kit from Dr. Fuel Cell is designed for class demonstrations and for hands-on use by students. It is created for investigations into solar and fuel cell



Item: 452891

Dr FuelCell fuel cell car, basic

This fuel cell car kit contains an electrolyser, which is reversible and can function both as an electrolyzer that generates hydrogen and as a fuel cell that generates



Item: 452892

Dr FuelCell Fuel Cell Car, Com

This model car kit contains parts to experiment with hydrogen production through electrolysis, where the power for the process is produced by a solar cell. The fuel cell is



Item: 452899

Fuel cell, spare part for DrFuel

Reserve part - Reversible fuel cell/electrolysis for DrFuelcell fuel cell vehicle.



Item: 452920

Fuel cell car, H-racer 2.0

This H-racer 2.0 is a remote-controlled mini hydrogen car with built-in fuel cell. The car has its own hydrogen station to produce hydrogen



Item: 452930

Fuel cell, ethanol

This fuel cell kit with propeller contains a fuel cell that produces power from an ethanol solution of up to 15%. This allows you to investigate how the power output of the



Item: 452940

Renewable energy kit

Complete energy kit for studying the production of different renewable energy sources. The kit consists of equipment



Item: 452980

Fuel cell vehicle, Hydrocar

With this hydrogen car, experiments can be set up to show that electrolysis with power from the solar panel can be used to produce the hydrogen that powers the car



Item: 452991

Fuel cell vehicle, kit with Hydro

With this kit, students can explore different ways in which sustainable energy can be produced, stored or used. In addition to the car itself, the kit consists of a fuel cell,



Item: 452996

HydroStik, full

A HydroStik is a container for storing hydrogen. The hydrogen is stored at low pressure in the form of metal hydride. It holds enough hydrogen for approximately



Item: 452997

Hydrofill, recharge

This is the tank you need to fill and refill your HydroStiks yourself. It is very easy to use: Plug the Hydrofill into the



Item: 453000

Voltmeter, student version

This electrolysis vessel is useful for conducting electrolysis experiments to detect/produce hydrogen and oxygen from a liquid. Together with the electrolysis



Item: 453005

Lid for voltmeter

Developed specifically for the electrolysis vessel (

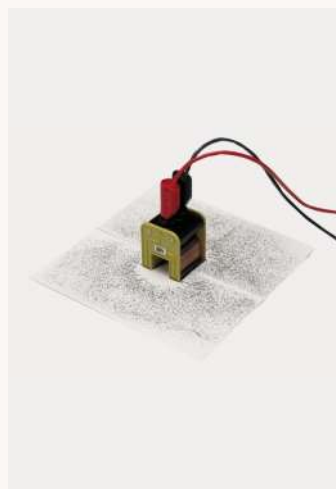

Item: 455200

Cardboard square for coil

Cardboard plate with cut-out for coil no. 462510. To demonstrate the magnetic field around a coil using iron filings.



Item: 455500

Pohl swing

To demonstrate the effects of a live wire in a magnetic field. Dimension: 270 x 100 x 160 mm.



Item: 455510

Laplace's Force apparatus

To demonstrate the effect of force on a current-carrying conductor in a magnetic field. The device consists of a pair of nickel-plated brass rails



Item: 456500

Current balance

This current balance can be used to demonstrate and measure the effect of an electric current on a magnetic field (Laplace's law).



Item: 456510

Current balance, angle-depen

To demonstrate and measure the influence of an electric current on a magnetic field in relation to the angle between the current direction and the magnetic field.



Item: 208510

Pulley on a rod

Plastic pulley, \varnothing 65 mm, mounted on stainless steel rod. Dimension of the rod: \varnothing 9.5 x 145 mm (total length 230



Item: 292510

Mirror on block, small

75 x 50 mm mirror block for reflection demonstration



Item: 444010

Faradays cage

Used to verify that an electric charge is on the outer surface of a body and that the cage acts as an electric shield. Dimension: \varnothing 125 x 300 mm.



Item: 151020

5 x Specific gravity weights, s

5 x density cylinder containing materials of equal weight and different volume. Materials: Aluminum, Brass, Nylon, Acrylic and PVC (



Item: 290320

Lens set, \varnothing 50 mm

The kit consists of 6 \varnothing 50 mm loose lenses. The lenses can be mounted in the lens and aperture holder 290201. The lens set can be used for a number of optics



Item: 151011

Specific heat weights, equal V

4 x different filler wires consisting of aluminum, copper, steel and zinc with the same volume.

Dimensions



Item: 704530

Hammer with wooden handle,

200 gram hammer with wooden handle.



Item: 301500

Refraction vessel, parallel plan

Plexiglass box. Equipped with plane-parallel sides. Suitable for optical experiments with refraction in liquids.

Dimension: 370 x 130 x 150



Item: 297520

Magnifying glass, unmounted,

Unmounted assembly lens. Diameter: 50 mm.



Item: 297620

Reducing glass, unmounted, Ø

Unmounted spreading lens. Diameter: 50 mm



Item: 306720

Plasma ball, small for USB

A small airless glass sphere with a small amount of noble gas. A built-in Tesla transformer produces high voltage at a very low amperage. This generates



Item: 306730

Kaleidoskop, DIY kit

This kaleidoscope allows students to investigate optical phenomena. Using mirrors, colorful patterns of colorful beads are formed inside the



Item: 260800

Thermometer 1600 °C, electro

An infrared thermometer can be used to measure surface temperature by pointing the thermometer at an object or surface.



Item: 398610

USB 2.0 cable, A male to USB

Accessories for 513550.

Specifications

- USB 2.0, male (type A).
- USB-C, male.



Item: 508070

Dual Beam Tube D

Electron beam tube, filled with neon at low pressure to determine a specific charge e/m.

"Electron pathways", double



Item: 287140

Ultraviolet bulb 13W (E27 sock

13 Watt UVA bulb (darklight) suitable for E27 socket (for 230 V) with a wavelength of 368nm.

Fits lamp holder 413030.

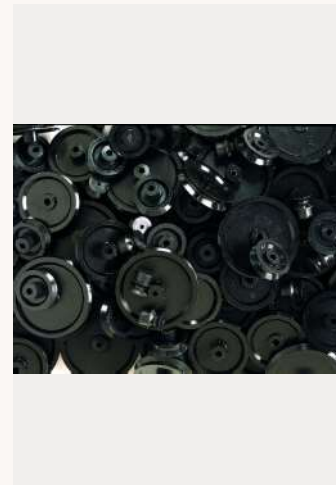

Item: 670169

Pulley set w. 20 pcs.

Disc set with 20 discs in four different diameters:

- With 3.2 mm. mounting hole:
- 5 x 40 mm.
 - 5 x 30 mm.

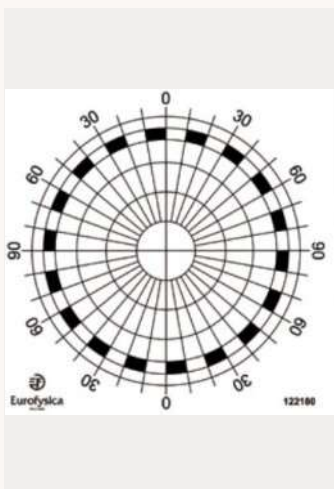

Item: 122180

Measurement of refraction an

Hard plastic plate for measuring light scattering when studying refractive index or reflection in prism
Dimension: 170 x 170 mm



Item: 352452

:::Battery charger for NiCd, Ni

Battery charger for 2 x AA/AAA or 2 x 9V E-block for NiCd and NiMH rechargeable batteries.

Automatic shut-off after 8



Item: 455025

Magnetfeltmodel, 14 vindinger

For use in producing an electric field with just 14-wire winding in lacquered copper.



Item: 308540

Colour wands

Three sets of 6 colored plastic plates for illustrating color mixing.



Item: 308900

Colour filter, foil, primary red

Transparent color film in roll of 50 x 122 cm.
The color filter is suitably colorfast and reasonably color correct according to



Item: 308920

Colour filter, foil, primary green

Transparent color film in roll of 50 x 122 cm.
The color filter is suitably colorfast and reasonably color correct according to



Item: 308930

Colour filter, foil, primary blue

Transparent color film in roll of 50 x 122 cm.
The color filter is suitably colorfast and reasonably color correct according to

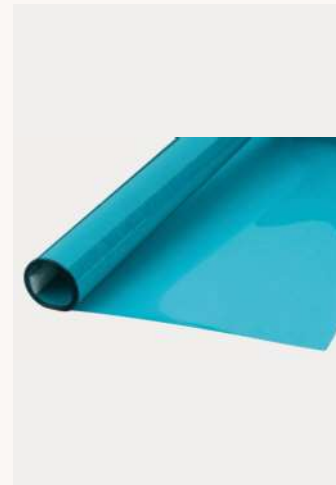

Item: 308950

Colour filter, foil, cyan

Transparent color film in roll of 50 x 122 cm.
The color filter is suitably colorfast and reasonably color-correct according to



Item: 309000

Colour mixer, blue, red and gr

A mixture of the primary colors red, green and blue (RGB for short) is called an additive color mix. When red, green and blue light are mixed in the right amount,



Item: 313110

Mysterious spinning top

Give this spinning top a spin and watch it spin for hours without stopping.
The secret revealed: The spinning top contains a small



Item: 351006

Battery, LR14, 1.5V, C

Standard 1.5 V battery. Type: Alkaline. Voltage: 1.5 V. Code: LR14 (C). Dimension: Ø 25 x 49 mm.



Item: 351007

Battery, LR20, 1.5 V, D

Standard 1.5 V battery. Type: Alkaline. Voltage: 1.5 V. Code: LR20 (D). Dimension: Ø 33 x 60 mm.
Sold in pack of 24 pcs.



Item: 351010

Battery, 6LR61, 9.0 V

Type: Alkaline Voltage: 9 V
Code: 6LR61 Dimension: 26 x 17 x 48 mm.



Item: 351510

Coin cell battery, LR1130, 1.5 V

Type: Alkaline Voltage: 1.5 V
Code: V10GA Dimension: Ø 11.6 x 3.0 mm. Typical application: digital clock.
Supplied in 5 pieces



Item: 351604

Button cell battery, LR44

Type: Alkaline, Varta.
Voltage: 1.5 V.
Code: LR44 / 13GA.
Dimension: Ø 11.6 x 5 mm.

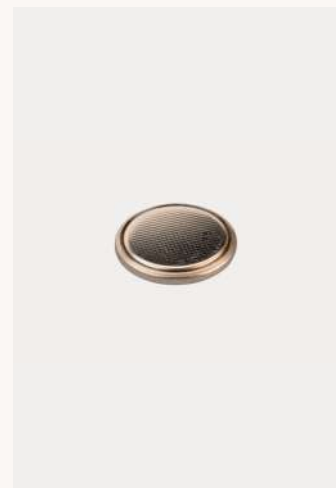

Item: 351605

Button cell battery, CR2025

Type: Lithium.
Voltage: 3 V.
Code: CR2025.
Dimension: Ø 20 x 2.5 mm.



Item: 351606

Button cell battery, CR2032

Button cell battery - CR2032 (sold in packs of 6)
Type: Lithium.
Voltage: 3.0 V.
Capacity: 220



Item: 351607

Button cell battery, CR2430

Lithium button cell battery 3V.
Weight: 0.2 kg.
Capacity: 256 mAh.
Dimensions: 3.1 x 24.5 mm.
Can replace similar



Item: 352030

Battery holder for 1 x D / R20,

Battery holder for 1.5 V batteries type LR 20 (D-size) as item no. 351007
Battery holders can be connected in series or



Item: 352031

Battery holder for 1 x D / R20,

The battery is placed inside the box. With 2 cable outlets with safety plugs.
Printed battery symbol.



Item: 352055

Battery holder for 1 x AA / LR6

Battery holder for 1 AA battery.
Dimensions:
57 x 16 x 13 mm.



Item: 352060

Battery holder for 2 x AA / LR

Battery holder for 2 AA/LR6 batteries
Connection: snap lock



Item: 352075

Battery holder for 1 x 9 V E-blo

Battery holder for one 9V battery (E-block) and connection via cable.
For the SKRAMLOTEKET theme set it is recommended



Item: 352100

Snap lock holder f. 1 x 9 V E-bl

Snap-lock with two wires to 9V battery or to battery holders.



Item: 352200

Voltaic pile

The Volta column is the first galvanic battery. Alessandro Volta invented the Volta Column in 1800, enabling the exploration of electric



Item: 352201

Zinc discs for voltaic pile 3522

Spare part for Volta column - zinc washers Ø53 mm.



Item: 352202

Copper discs for voltaic pile 3

Spare part for Volta column - Copper washers Ø53 mm.



Item: 321532

Okular - Reservedel til 321530

Ocular - Spare part for spectroscope 321530.



Item: 663006

Battery Power for Micro:Bit

Compact battery-powered power source for micro:bit.
Includes:
 Breakout board for battery holder for micro:bit.



Item: 352330

Rechargeable battery HR6 1.2

Type: Ni-Mh.
 Voltage: 1.2 V.
 Capacity: 2100 mAh.
 Code: R6 (AA).
 Size:



Item: 408533

Miniature fuses, 20 mm, 1 A, F

Melting fuse with glass tube 250 V, fine fuse.
 Dimension: Ø 5 x 20 mm.
 Capacity: 1 A.
 Type: F (fast reacting)



Item: 408554

Miniature fuses, 20 mm, 200

Melting fuse with glass tube 250 V, fine fuse.
 Dimension: Ø 5 x 20 mm.
 Capacity: 200 mA.
 Type: F (fast acting).



Item: 409640

Ceramic fuse, 25 mm, 10 A, S

Melting fuse, fine fuse.
 Dimension: Ø 6.3 x 25 mm.
 Capacity: 10 A.
 Fits digital multimeter with order no. 386215.



Item: 409660

Ceramic fuse, 25.4 mm, 2 A

Reserve fuse for multimeter TECPEL (386225)



Item: 200585

Ticker tape holder

Holder til papirrulle til prik-timer.



Item: 708031

Soldering tip

Soldering tip Longlife tip 51, diagonally cut 3-4 mm for soldering iron 708010.



Item: 304020

Plane mirror, glass

Mirror-coated glass plate for mounting in plate holder no. 305000.
Dimension: 180 x 120 mm, 2 mm thick



Item: 330850

Bar magnets, moulded in plast

Two bar magnets with dimensions 178 x 22 x 12 mm moulded in plastic.



Item: 331500

Horseshoe magnet, large

U-shaped and powerful AlNiCo magnet with colored poles. Equipped with an anchor.
Dimension: 30 x 82 x 135



Item: 331510

Horseshoe magnet, small

U-shaped and powerful AlNiCo magnet with colored poles. Equipped with an anchor.
Distance between poles 48.7



Item: 331514

Magnetic balls

Magnetic ball with a diameter of 17 mm.
The magnets are plastic coated and available in assorted colors.



Item: 331516

Magnets, super

Experience the enormous pull of these super magnets. They are designed to allow the student to explore the use of neodymium magnets. Supplied as a set of 2. The



Item: 331600

Magnet set

The set consists of a wide selection of different magnets and materials for experimenting with magnets and magnetic force.



Item: 331700

Horseshoe electromagnet

To demonstrate electromagnetism. This electromagnetic coil becomes magnetic at a voltage connection of 4 - 6 V



Item: 331800

Neodymium magnets, Ø6 x 8

Very strong magnets that effectively illustrate the properties of magnetic materials. The magnets are so powerful that even the properties of very weak



Item: 331810

Neodymium magnets, Ø10 x 8

Ceramic and very strong magnets that effectively illustrate the properties of magnetic materials. The magnets are so powerful that even the properties of very



Item: 331820

Neodymium magnets, Ø14 x 8

Ceramic and very strong magnets that effectively illustrate the properties of magnetic materials. The magnets are so powerful that even the properties of very



Item: 332010

Cylindrical magnet with bearing

Powerful magnet with colored poles, mounted on a sturdy stainless steel rod with a diameter of 10 mm. This magnet is ideal for teaching physics, magnetism and



Item: 333000

Swivel stand for bar magnet

Suitable for bar magnet to demonstrate repulsion and attraction. Made of nickel-plated brass. For magnets up to 11 mm in



Item: 321005

Compact Spectroscope

Handheld spectroscope in a metal housing that allows you to qualitatively observe the spectrum of spectral lamps and other light sources.



Item: 321015

Compact spectroscope, pock

A cheaper alternative to the popular TE313 handheld spectroscope, where the price difference is due to a lower sharpness of observation of spectral lines,



Item: 321030

Hand-held spectrometer

An affordable handheld spectroscope with printed scale and line spectra for a range of elements. This spectroscope is ideal for



Item: 321530

Spectrometer

For determining the wavelength of visible light by diffraction in an optical grating or refraction in a prism. The instrument is equipped with an easy-to-read scale with a



Item: 323010

Single slits, various widths

Includes 5 single slits of different widths to demonstrate the deflection of light in a slit.
Slit width: 0.04 - 0.08 - 0.14 -



Item: 300000

Hollow prism, 50 mm, glass

Hollow prism of 3 mm glass with removable lid. For demonstrating the refractive index of liquids.
Outer side length: 50 mm.



Item: 663024

Prong Soil Moisture Sensor for

This micro:bit soil moisture sensor is a sensor that can be mounted directly on a micro:bit processor board to monitor the moisture present in soil, for



Item: 663022

Klimate board for micro:bit

The micro:bit climate sensor allows you to measure temperature, barometric pressure and humidity. The Real Time Clock (RTC) allows to read the current



Item: 754530

Paper fasteners

Brass.
100 pcs.



Item: 352445

Battery tester

Universal battery tester for 1.5 V and 9 V batteries.



Item: 355035

Universal Power Adapter, 3 - 1

Universal DC switchmode power adapter. Choose from 7 different stabilized output voltages and 7 different plug types.



Item: 355050

Power adapter, 12 V, 1.5 A, DC,

Switchmode power adapter. Stabilized 12 V DC output voltage.

Specifications

Power supply: 100 – 240 V



Item: 278520

Steam whistle for D16

Reserve boiler for steam engine D16 - Wilesco



Item: 441015

Electroscope

For demonstration of electrical charges. When a charge is applied to the electroscopes, the pointer rotates and indicates the size of the charge. The



Item: 292520

Mirror on block

Plane mirror on block used for refraction of light
Length: 152.4 mm
Height: 50.8 mm



Item: 452935

Salt water Fuel cell

Saline water fuel cell kit illustrating a fuel cell concept that combines a salt water electrolyte with magnesium plates to generate electrical energy. (As oxidation occurs,

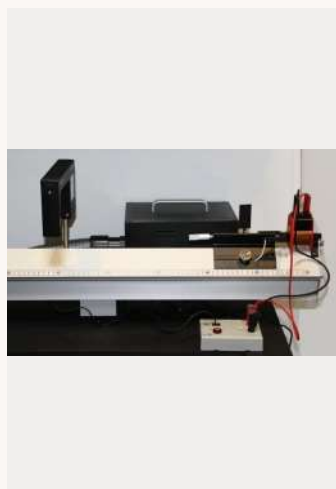

Item: 198515

Switch box for Airtrack

The switch box is used as an accessory for the air cushion bench when performing acceleration tests, i.e. the switch helps to ensure that the carriage on the air

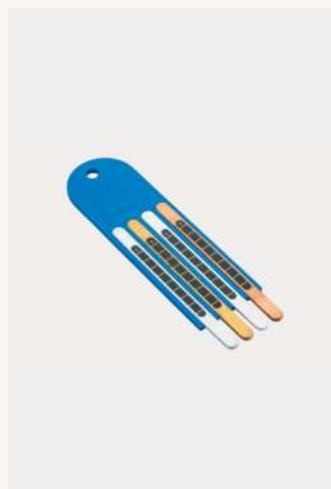

Item: 269210

Heat conduction rods, 4 x met

Consists of four metal rods of steel, brass, aluminum and copper embedded in the same plastic holder. Each of the rods is equipped with a liquid crystal indicator to



Item: 298535

Flint glass prisms, Index 1.62

Triangular prism made of flint glass, which gives a strong and clear light refraction. The prism has significantly better light refraction than prisms made of plastic.



Item: 406060

Tesla meter with sensor, up to

Used to measure the magnetic field of various magnets, coils and electromagnetic arrays. The instrument is equipped with a digital display that



Item: 197080

Air Blower for Air Track 230 V

Spare part for Air Track
The blower is continuously adjustable and silenced. Equipped with fuse and light indicator for connected



Item: 409013

Miniature fuses, 20 mm, 4 A, S

Melting fuse with glass tube 250 V, fine fuse.
Dimension: Ø 5 x 20 mm.
Capacity: 4 A.
Type: T (slow acting).



Item: 410000

Fuse wire (Silver)

Silver wire that burns out at 3 A.
Used in connection with fuse wire holder no. 410500.
Roll of 50 m.



Item: 412015

Lamp holder, E10

Lamp holder for both mini cables and safety cables.



Item: 414520

Knife switch, mini, simple

Single pole, single mini grip switch or knife switch with screw contacts for connecting cables.



Item: 414530

Knife switch, mini, two-way

Single pole, double lever or knife switch with screw contacts for connecting cables.



Item: 506030

Planck's constant - diode char

The equipment is designed to determine Planck's constant from the breakdown voltage of a number of LEDs and the corresponding frequency of light for the



Item: 284060

Control transformer 230 V

Used as a power supply for Frederiksen spectral lamp housings. For safety reasons, the power supply is equipped with a 3-pin socket that fits the spectral lamp housing;



Item: 513550

GM counter Handheld with bu

This handheld Geiger counter is a flexible device specially designed for schools and other educational institutions. Use the built-in GM tube with the protective cap on for



Item: 306600

Plane mirror, acrylic

Mirror coated plastic plate, does not splinter, can be cut with scissors. Mirror coated on one side.

Dimensions: 90 x 65 x 1.2

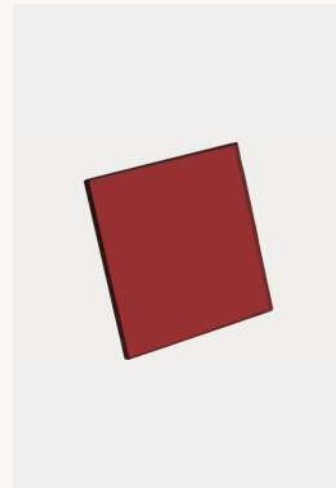

Item: 308500

Colour filter, acrylic, red

Color filter made of 3 mm acrylic sheet, fits in aperture holder 295080 and 297000.

Dimension: 50 x 50 mm.

Color: red.

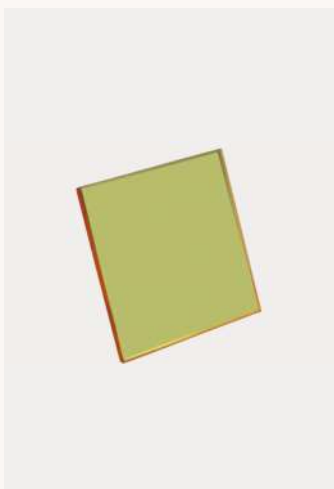

Item: 308510

Colour filter, acrylic, yellow

Color filter made of 3 mm acrylic sheet, fits in aperture holder 295080 and 297000.

Dimension: 50 x 50 mm.

Color: yellow.

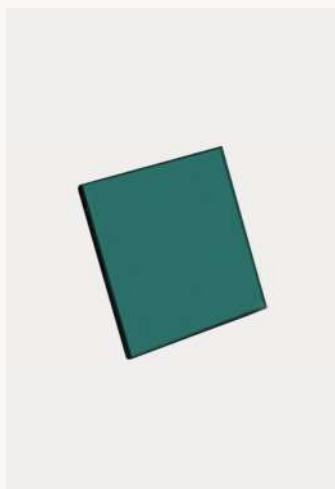

Item: 308520

Colour filter, acrylic, green

Color filter made of 3 mm acrylic sheet, fits in aperture holder 295080 and 297000.

Dimension: 50 x 50 mm.

Color: green.

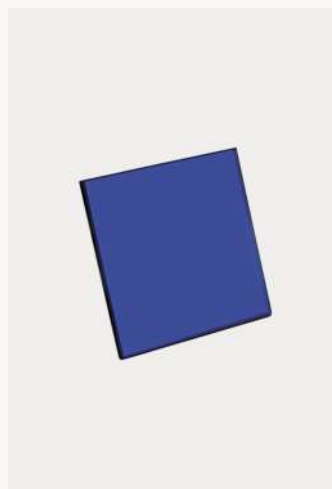

Item: 308530

Colour filter, acrylic, blue

Color filter made of 3 mm acrylic sheet, fits in aperture holder 295080 and 297000.

Dimension: 50 x 50 mm.

Color: blue.



Item: 708112

Sponge for stand

Separate soldering sponge for soldering iron holder 708410.



Item: 305000

Plate holder

Made of polished stainless steel.
Width: 20 mm
Height: 40 mm



Item: 306610

Concave / Convex Acrylic, Sm

Mirror coated plastic plate. Mirror coated on both sides and shaped like a hollow mirror.
Contains 10 pieces.



Item: 330530

Bar magnets, small cylindrical

Set of 2 uncolored AlNiCo bar magnets.
Dimension: Ø 5 x 50 mm.



Item: 639220

Lamp holder E10 with solder ta

Mini lamp socket E10 with solder tabs, ideal for use with mini cords (106220).
10 pcs bag.



Item: 194520

Air cushion plate using balloo

Learn about collisions and acceleration.
The set consists of five air cushion disks, five balloons and five corks.



Item: 306710

Mirage - 23 cm

This Mirage set is ideal for demoing the Mirage phenomenon - you can see it but not feel it!
Mirage is, as the name



Item: 174515

Suction and pressure fan - 174

Fan with electronic control, continuously variable speed. Works as a pressure fan for open airflow together with wind tunnel or suction fan in connection with the wind

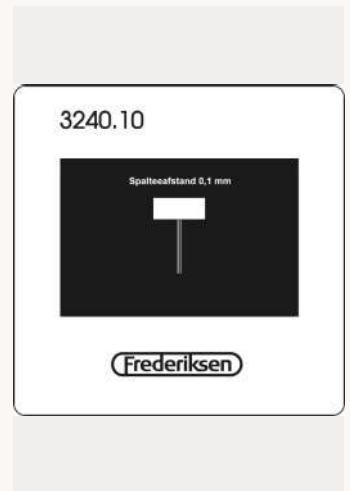

Item: 324010

Double slit

Mounted in frame.
Dimension: 50 x 50 mm.
Gap spacing: 0.1 mm.
Gap width: 0.01 mm.



Item: 324500

(Paton Hawksley) Diffraction g

Grid copy mounted between 2 glass plates 50 x 50 mm in slide frame.

Grid area: approx. 25x 25 mm.



Item: 324510

(Paton Hawksley) Diffraction g

Grid copy mounted between 2 glass plates 50 x 50 mm in slide frame.

Grid area: approx. 25 x 25 mm.



Item: 324520

Diffraction grating, 1200 l/mm

Grid copy mounted between 2 glass plates 50 x 50 mm in slide frame.

Grid area: approx. 25x 25 mm
The grid is based on US



Item: 324560

Diffraction glasses

See the world with new eyes!
It becomes more colorful with these glasses consisting of a two-dimensional optical lattice.

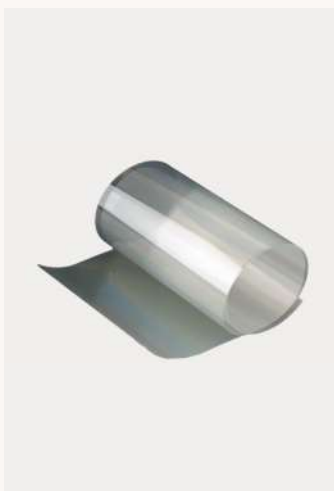

Item: 324580

Optical grating, sheet

500 l/mm (The film has lines in one direction only)

Optical grid on 15x60 cm plastic sheet.

Can be cut out and mounted



Item: 325000

Diffraction grating, 100 l/mm

Grid copy mounted between 2 glass plates.

Grid area: 45 x 30 mm

Dimensions: 63.5 x 48 mm

Number of lines per mm: 100



Item: 325010

Diffraction grating, 200 l/mm

Grid copy mounted between 2 glass plates.

Grid area: 45 x 30 mm.

The grid is based on US measurements; the exact



Item: 325020

Diffraction grating, 300 l/mm

Grid copy mounted between 2 glass plates

Grid area: 45 x 30 mm

Dimensions: 63.5 x 48 mm

The grid is based on US



Item: 325030

Diffraction grating, 600 l/mm

Grid copy mounted between 2 glass plates.
Grid area: 45 x 30 mm
Dimensions: 63.5 x 48 mm
Number of lines per mm: 600



Item: 325505

Diffraction grating, 300 l/mm,

Optical grid mounted on glass plate, for use with e.g. spectrometer 321530, for determining the wavelength of spectral lines.



Item: 325510

Diffraction grating, 600 l/mm,

Optical grid mounted on glass plate, for use with e.g. spectrometer 321530, for determining the wavelength of spectral lines.



Item: 326000

Optical gratings, 100/300/600

Original version from Paton Hawksley.
Three grids with 100, 300 and 600 lines/mm respectively, mounted between



Item: 327000

Polarising filters, unmounted

Unmounted polarization filters for producing plane polarized light. Quality filters that close completely when placed 90 degrees apart.



Item: 327011

Polarising Filter, 20 x 25 cm

Quality filters that close completely when placed 90 degrees apart. (transmit less than 0.005% with crossed filters).



Item: 327020

Polarising filters, slides

Mounted polarization filters for producing plane-polarized light. Quality filters that close completely when placed 90 degrees apart.



Item: 327200

Laser diffraction set

The set contains 18 slides for demonstration of e.g. "Fraunhofer Diffraction", "Fresnel Diffraction" and a number of other deflection



Item: 327305

Smoke spray

Magican Smoke Spray is your easy and smart solution for creating smoke in smaller indoor spaces. No more hassle with smoke machines and liquids - Magican is ready



Item: 293503

Sparepart for 293500, Color P

Spare set of color plates for optics kit 293500



Item: 361055

Power supply, 1-12 V, AC/DC

Stepwise adjustment of both AC and DC with 1 V between steps.
The DC voltage is not smoothed or stabilized, and



Item: 361065

Power Supply, 2 - 24 V, AC/D

Step setting of both AC and DC with 2V between steps. Protected against overload with automatic fuse. The DC voltage is not



Item: 361600

Power supply, 12 V, AC/DC, 3

The power supply delivers a stabilized DC voltage that is infinitely adjustable between 0 and 12 V. In addition, an AC voltage is



Item: 361870

Power supply 34 V DC / 25 V

Stepless regulation of both AC and DC. The DC voltage is bidirectional and smoothed, not stabilized (small pulses in the current).



Item: 362510

Power supply, 15 V, 3 A, DC

Compact DC power supply with digital display for reading voltage and current in two separate displays. Equipped with safety bushings.



Item: 362520

High-voltage supply, 10 kV

For safety reasons, the current is limited by a built-in series resistor. The short-circuit current is a maximum of 2 mA.



Item: 362570

Power supply, 0-30 V, 20 A, D

Stabilized, variable DC power supply with digital display of voltage and current. Equipped with sockets for +, - and ground. Protected against overload. Safety



Item: 364000

Power Supply, 0 - 24 V, AC/D

This power supply is a solid choice for the physics classroom where both flexibility and safety are required. You can easily adjust both voltage and



Item: 364010

Power Supply, 0 - 24 V, AC/D

A highly versatile power supply for all low-voltage experiments. Stepless voltage regulation, separately for DC and AC. The two outputs can be loaded



Item: 367060

Power supply, 0 - 6000 V, DC

The power supply delivers a stabilized DC voltage that is infinitely adjustable between 0 and 6 kV. For safety reasons, the current is limited by a built-in series resistor.



Item: 370001

Replacement Band for 37005

Spare part for the current models of the Van de Graaff generator from Frederiksen. Width: 50 mm. Length of the SLAP tape:



Item: 370002

Drive Belt for 370050/60

Spare parts kit for Van de Graaff Generator [370060](#) (Previous item no. 370050). In the k



Item: 370060

Van de Graaff generator

Used to generate very high DC voltages (100 kV) at very low amperage, making testing with the generator safe (OBS: not recommended for use with people with pacemakers)



Item: 370500

Conductor sphere 10 cm on rod

Conductor ball for use with Van de Graaff belt generator (370060). Used for collecting charge from the belt generator, the rod of the conductor ball is equipped



Item: 371600

Tesla Transformer, Set

Tesla transformer for generating high-frequency, damped oscillations at high voltages. The oscillations are generated in a primary circuit consisting of a coil, capacitor



Item: 381160

Voltmeter, analogue

Analogue DC voltmeter with large, clear 45° inclined display and two scales with measuring ranges: -5 to +15V and -1 to +3V



Item: 381170

Ammeter, analogue

Analogue DC ammeter with large, clear 45° tilted display and two scales with measuring ranges: 0 to 5 A and 0 to 1 A



Item: 381175

Galvanometer, analogue

Galvanometer or microammeter for measuring a small amperage. Equipped with a large, clear 45° inclined scale. Suitable for displaying induction in a



Item: 381560

Voltmeter

Robust and easy-to-use instrument that is easy for students to read. Measures both DC and AC voltage. The instrument is



Item: 381570

Ammeter

Robust and easy-to-use instrument that is easy for students to read. Measures both direct and alternating current.



Item: 381580

Frederiksen Galvanometer

Robust and easy-to-use instrument that is easy for students to read. Measures small direct currents. Scale equipped with



Item: 472025

Solcelle motor (30 mA)

This is a 2 V motor with low moment of inertia, and can therefore be used by a solar cell with low current production (max. 30 mA).



Item: 400110

Oscilloscope 100 MHz PC - 2

Two-channel 100 MHz digital storage oscilloscope. Connects to the PC via USB. Has all the settings of a traditional oscilloscope - simply operate via software.



Item: 221105

Ripple Tank without Vibrator a

The basic properties of waves are the same whether they are water waves, sound waves or electromagnetic waves such as light. Therefore, the wave tank



Item: 197560

Photo Cell w. modular connect

For measuring pendulum oscillations, time measurement on air cushion rail, measurement of rotation time etc.

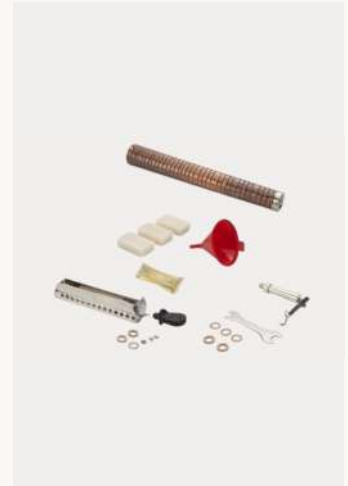

Item: 278525

Accessories in a bag for stea

Spare parts kit with parts for steam engine D16 (Wilesco)



Item: 439500

Swivel stand

Used as a rotatable holder for rubbing bars to examine the polarity of static electricity. Diameter of base: \varnothing 42 mm Height: 95 mm



Item: 306705

Mirage, student model

This Mirage set is suitable for use as a class set. What is Mirage? - The object can be seen without you being able to touch it and what the name describes is an optical



Item: 260822

Thermal Camera FLIR C5 - Wi

The FLIR C5 thermal imager with WiFi connectivity is the ideal tool for educational visualization of heat and infrared temperature. Top quality thermal imager for



Item: 356030

Charging Station 10 Port USB

Practical charging station with 10 USB sockets, which can be useful, for example, if the school has many of the new wireless sensors that require charging via USB.



Item: 260825

Tripod for thermal camera

This tripod is used together with thermal imaging camera 260821.



Item: 398630

HDMI Male to micro-HDMI Ma

High Speed HDMI with Ethernet. HDMI A male to HDMI D male (micro).

Specifications:
Connectors: HDMI A male to



Item: 002600

Support for electrode holder

Used as a clamp for electrode holder 449710.
Can also be used as a holder for round GM tubes and older microphones like 248510.



Item: 200525

Carbon discs for timer Ø64 m

Extra Carbon washers for Ticker tape timer 200500. Ø64 mm. 10 pcs.



Item: 422320

Load Box for solar Cells

Load box for use with smaller solar panels, fuel cells and similar small power generating devices.
The box is the perfect partner



Item: 280100

70 watt Halogen bulb, E27

70 W Halogen bulbs on E27 base for use in solar energy trials

Specifications:
Voltage: 220 - 240 V



Item: 212105

Sparepart for Rokit rokit

Keep the classes going - and the rockets flying! This complete spare parts kit contains everything needed to get your Water Rokit back in the air. Suitable for



Item: 199745

Steel Ball, Ø 19 mm - sparepar

Erstatningskugle til disse produkter køslasht; hos Frederiksen 199015, 344010 og 670099.



Item: 260815

Thermometer 1050 °C, electronic

An infrared thermometer can be used to measure surface temperature by pointing the thermometer at an object or surface.



Item: 343010

Declination and inclination needle

This declination and inclination needle can be used to experiment with determining the polarization of magnetic fields, including electromagnetic



Item: 513620

GM counter

This Geiger counter can be used to count the number of decays from various radioactive sources. The decay is heard as the

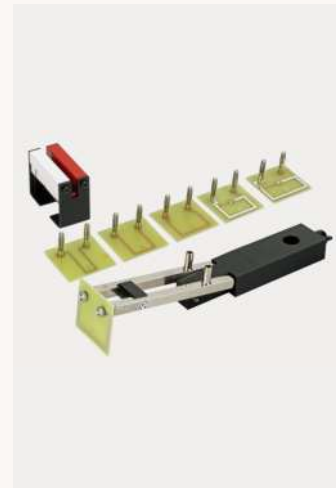

Item: 456505

Spare Print for Current balance

Spare parts kit for power scale 456500 that contains six replacement prints corresponding to the prints included when purchasing the power



Item: 203705

Drive belts, 580mm

The set consists of 5 flexible drive belts made of synthetic black elastic material in length 580 mm. The belts are oil resistant.



Item: 409650

Fuse, 10 A, for 386231

Fuse 10A for 386231, 1000 V Ø10.3 x 38.1 mm FF



Item: 005700

Matches, no sulphur

A bag with 500 - 600 match sticks. The wooden sticks are sulphur-free and can be glued together for various technology and natural engineering projects. Great



Item: 582010

Plastic's capabilities (Radiated)

The kit can be used to investigate the properties of plastics under different influences. Inspiration for this can be found in the book "Chemical production and



Item: 504610

Propeller, 115 mm

The propeller is molded in black plastic and has a \varnothing 2 mm mounting hole that precisely fits the winding shaft of the 472000.



Item: 438005

Rubbing rod, Plexiglas

Plexiglass rod (Acrylic) for generating static electricity by rubbing with a fabric or skin. Dimensions: \varnothing 14 x 300 mm.



Item: 202555

Gear motor with winding shaft

This gearmotor is used with the 207010 conical pendulum and is powered by an adjustable DC motor (max. 12 V). It has a built-in 21:1 gearing that ensures a stable



Item: 197710

Free-fall tube

<div id="tw-target-text-container" tabindex="0"><p data-placeholder="Oversættelse" dir="ltr" id="tw-target-text">Til at demonstrere, at tunge eller



Item: 293502

Light box for optic set 293500

Light box for optics kit 293500.



Item: 194625

Rocket car

Small, easy-to-drive plastic car with a real airbag in the shape of a balloon. When the air rushes out of the balloon, the car moves. To demonstrate the principle of a



Item: 514008

Absorber plate kit (Incl. Tin)

Set of two types of metals as absorber plates for radioactivity shielding studies.

Tin plates:

- 6 thick (2 mm)



Item: 514015

Absorber plate - Tin 2 mm

2 mm tin plate used for shielding radioactive radiation.

Tin replaces lead as a shielding material.



Item: 515020

Smoke chamber for Brownian

To demonstrate Brownian motion in smoke particles (gas) through a microscope. Tested for laser light. The device has a built-in laser that



Item: 140540

Stainless steel rules 50 cm wit

50 cm ruler with scratch-resistant text on stainless steel. Graduation is applied on both sides in mm/cm. The ruler starts directly with 0, making it suitable for depth



Item: 217740

Slotted weights 5x 50g

Slicing mass set 250 grams, made of brass, consisting of: 1 x 50 gram (holder), 4 x 50 gram slicing masses.



Item: 452938

Magnesium plate for Salt water

Spare part for salt water fuel cell 452935.



Item: 288550

Laser, He-Ne, modulatable

The laser emits light with a wavelength of 632.82 nm in air. The wavelength is completely stable and can be used as a reference.



Item: 398615

USB 2.0 cable, A male to micr

Used for charging and communication in connection with a number of PASCO's wireless sensors.



Item: 490001

Heat pump

Demonstration heat pump especially for educational use. Consists of compressor and cooling and heating coils.



Item: 188800

Light Meter, digital

Digital lux meter with large measuring range and large, easy-to-read 4-digit display. Operates in 3 different measuring ranges that automatically change as the



Item: 151215

Mole balloon, 24 L

Reserve balloons 24 L for 151210 Mol kit. The balloons are printed with the text: N₂, O₂, Ar, CO₂
29.0 g



Item: 212122

Spare Rocket for 212121

If all the rockets have disappeared, you now have the opportunity to buy 3 spare rockets.
Spare rockets for



Item: 287105

UV-C lamp for 287100

Intense light source for studying photoelectric effect. The bulb is used together with item no. 287100.
Do not connect directly to the



Item: 324530

Optical gratings,3-in-1

Combination grid with 100, 300 and 600 lines/mm. The entire frame is 90 x 26 mm.
The grid windows are 12 x 16



Item: 413030

Lamp holder, E27 on base 230

E27 socket 230 V (for incandescent lamps) mounted on a solid base plate with mains plug and switch.



Item: 507010

Franck-Hertz Experiment Pow

Accessory for Franck-Heartz. This device is to be used together with the Franck-Hertz 507000 and functions as a power supply unit.



Item: 599502

Wind Generator for 599500

Used together with CVK suitcase Aerodynamik 599500 to generate a low-turbulence, unidirectional airflow for aerodynamic tests.



Item: 649005

Permanent Marker, edding 801

The ink is quick-drying, waterproof, lightfast and weatherproof.
• Color: Black
Stroke width: 0.75



Item: 438025

Rubbing rod, PVC rod

Rod (PVC) for generating static electricity by rubbing with a fabric or skin.
Dimensions: Ø 14 x 300 mm.



Item: 439025

Rubbing cloths, PVC (woven)

Woven polyester fabric piece covered with PVC for static electricity testing.
Dimension: 30 x 30 cm.



Item: 670131

Coloured film, A4, 5 different c

5 different colored plastic sheets in A4 format.
Great for experimenting with color mixing, preferably on an OH.



Item: 598700

Magnets and compasses, CV

This kit contains teaching materials for experiments on two closely related topics: Magnets: (Grades 1-2). Students can begin by

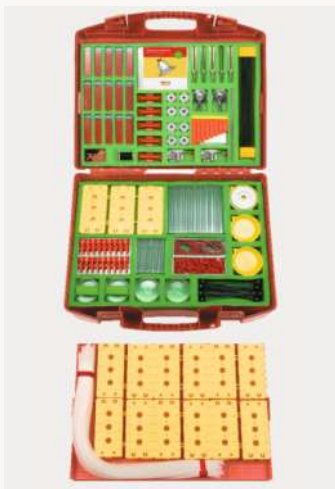

Item: 599100

Tones and sounds, CVK case

This suitcase can be used to introduce students to various concepts such as naming sounds (noise, multiple sounds simultaneously, animal sounds, etc.),



Item: 599500

Aerodynamics, CVK set

The kit contains equipment and materials to demonstrate the basic processes and connections that enable flight using static or dynamic lift and the principle of



Item: 503750

Hot water container

Reserve part for solar collector (item no. 503720)



Item: 506020

Planck's constant with LEDs

This device uses the photoelectric effect to determine Planck's constant. The device contains voltmeter and nanoamperemeter with built-in measuring amplifier.



Item: 507000

Franck-Hertz apparatus, merc

To determine the first excitation energy level of 4.9 eV for mercury.

The product consists of a mercury-filled vacuum tube



Item: 507500

e/m tube

Used to determine the relationship between the electron's charge and its mass, also known as e/m. The vacuum tube is



Item: 508005

Thomson e/m tube, deflection

This demonstration tube is used to study the movement of electrons in the electromagnetic field.

The tube has the capacitor



Item: 508035

Electron diffraction tube, Teltr

The tube can be used to demonstrate the wave nature of the electron, as well as an opportunity to measure the de Broglie wavelength of the electron. Together with the



Item: 508060

Stand for Teltron tube, type D,

Tentron tube type D is used in this stable holder.

The tube can rotate 360 degrees around its longitudinal axis. The base



Item: 508505

Thomson e/m tube, Teltron 25

Used to study the movement of electrons in the electromagnetic field.

The tube is equipped with a fluorescent screen that traces



Item: 509600

X-ray Apparatus

Fully equipped microprocessor controlled X-ray or X-ray apparatus with molybdenum tubes and goniometer designed to perform a wide range of



Item: 488534

Solar cell car, rechargeable

Great model car - charge the batteries when the sun is shining or under a bright light and the car can drive without the sun.



Item: 488538

Solar panel, 10 W, monocrystal

This solar panel is constructed with 36 series-connected monocrystalline single cells in an aluminum frame with front glass. The solar cell delivers a total



Item: 488541

Solar panel with screw term, 0.

Suitable for investigating the significance of the area and number of cells and for measuring characteristics. Sealed solar cells with screw terminals on the back;



Item: 488542

Solar panel with screw term, 0.

Suitable for investigating the significance of the area and number of cells and for measuring characteristics. Sealed solar cells with screw terminals on the back;



Item: 488543

Solar panel with screw term, 1

Suitable for investigating the significance of the area and number of cells and for measuring characteristics. Sealed solar cells with screw terminals on the back;



Item: 488544

Solar panel with screw term, 2

Suitable for investigating the significance of the area and number of cells and for measuring characteristics. Sealed solar cells with screw terminals on the back;



Item: 488570

Solar Cell Charger with Power

This power bank can be used to demonstrate that solar energy can be stored as electricity in a storage device. The power bank is paired with



Item: 488580

Solar cell kit

A single small solar kit that includes solar panels, motor, sounder, light source, interconnecting cables and more.



Item: 488705

Electrically conductive glass

This is an ITO (Indium Tin Oxide) glass plate that can conduct an electric current. The plate can be used as the outer layer (film) in a solar cell



Item: 500500

Motor for solar cell

Motor with propeller that when paired with solar cells can demonstrate that the power production in the solar cell is converted into power in the motor. The 6 V DC motor



Item: 500525

Wind Power Beast

Make your own mini wind energy beast that runs with the help of the wind or by hand. This model is made of plastic,



Item: 500545

Wind turbine incl. blades and

This turbine model can be used to investigate how there is a correlation between blade profiles and the power they can produce.



Item: 500560

Wind Turbine Kit

The EcoStyle Wind Turbine Kit is a working model of a real wind turbine. It is designed for use in schools, colleges and universities. It is a hands-on model that shows



Item: 637820

Loudspeaker, 25 Ω, 1 W

Ø 64 x 19.4 mm



Item: 509610

GM counter tube for X-Ray ap

Geiger-Müller tube in a plastic housing with a very thin mica window that also allows detection of soft β-radiation. With permanently attached cable. Complete with a



Item: 510040

Storage container f. Radioactiv

Plexiglass holder for three Risø sources
Protects the sources from physical damage. Completely absorbs the sources' emitted



Item: 511205

Extraction liquid for isotope ge

Bottle with 250 mL extraction fluid for isotope generator 511200, consisting of an isotonic NaCl solution. Please note that the warranty



Item: 511710

Steel cabinet with combinatio

Removable steel cabinet for storing radioactive sources. The cabinet has plenty of space for isotope generator and Risø sources. Comes



Item: 512110

Spark detector

Spark detector for visualizing alpha particles.

- Alpha radiation can be both seen and heard



Item: 512515

GM tube on post, BNC conn

This Geiger-Müller tube is a Frederiksen developed GM tube with BNC connector. The tube can be used for use in experiments with detection of alpha, beta or gamma



Item: 512525

GM tube, extra sensitive, BNC

Highly sensitive GM tube with an extra large window of 27.88 mm in diameter. This makes the tube ideally suited for measurements involving low amounts of ionizing



Item: 512565

USB communication adapter f

USB communication adapter for 5136XX GM counter. Length: 1.8 m. USB A to 3.5 mm mini jack.



Item: 514100

Mounting bench for Risø sour

Complete set-up bench for Rice sources and GM tubes that provides a stable set-up for experiments with radioactive radiation.



Item: 514102

Rail for mounting bench, 45 c

470 mm rail for use with 10 mm rider. Can be used as a spare part for installation bench 514100 or 3-phase AC bench



Item: 514105

Deflection of beta part, Risø s

Exciting and simple device with permanent magnets. The magnets can be rotated to reverse the field and can be removed completely.



Item: 514180

Source holder, bench, simple,

Source holder without protractor for optical bench / profile rail.



Item: 514200

Muon observatory

Stand material for both shower mode and telescope mode trials. Heavy-duty construction, with space for a maximum of 40 steel absorbers (20.5 kg!). Includes



Item: 594815

One-way valve

One-way valve, plastic
Dimensions:
- Stud: Ø4 mm
- Stud length: 15 mm



Item: 500600

Floor-standing fan, Dia. 40 cm,

This large 80 W fan is excellent for indoor experiments with wind turbine models. The maximum rotation speed is 1300rpm.



Item: 503720

Solar thermal collector, compl

This solar collector model is developed and produced by Frederiksen Scientific and can be used to demonstrate how the sun's radiant energy can be converted into heat.



Item: 512634

Radon detector

Handy digital radon detector designed for radon measurement in homes. The radon detector allows you to continuously read average values for the last 24 hours,



Item: 514005

Source holder with absorber p

Source holder for Rice sources with shielding plates for experiments with absorption of ionizing radiation. The holder is equipped with a Ø 10 mm



Item: 514007

Source holder without plates

Holder for risers without absorber plates and without base. The holder is equipped with a Ø 10 mm clamping rod and a



Item: 598010

Experiment suit case, air, 6 gro

This suitcase contains equipment for 6 work groups. Includes balloons, pump, balloon cars, rocket model, stopwatch, valves, hot air



Item: 598015

Solar blimp, 3 m, Ø60 cm

A large airship with a length of 3 meters and a diameter of 60 cm. Consists of a thin, black plastic cylinder that is closed at one end with a piece of string. The airship is



Item: 598200

Heat, CVK case

A topic that is always relevant regardless of the season. Students build their own thermometer and learn how a thermometer works by reading temperature



Item: 670124

Colour disc, rotating

Also known as Newton's disk. Mounted on a stand. Diameter: 20 cm.



Item: 060003

Galileo Thermometer

Based on the principle that the density of a liquid changes with temperature and thus the buoyancy of the orbs. The temperature is displayed using small



Item: 708010

Soldering iron, 25 W

Supplied with Longlife pointed bit 51, bevel cut 3-4 mm. The soldering iron is equipped with a Danish three-pin ground socket.



Item: 641810

Copper wire, insulated, Ø0.30

Spolen med kobber vejer 515 g, heraf vejer kobbermængden 500 g.



Item: 642305

Power Cord, Danish with Earth

Three-legged power cable. Spare part for appliances that can be connected to the mains.



Item: 300620

Circular aperture slide, Ø4 mm

Iris mounted in glassless slide frame. Fits in aperture holders 295080 and 297000. Hole diameter: Ø4 mm.



Item: 305500

Projection screen, frosted

Made of 3 mm thick plexiglass with one side frosted. Equipped with Ø 10 mm clamping pin.



Item: 224562

Tuning forks on resonance box

Spare part for tuning forks on resonance box (224520 and 224530)



Item: 247500

Kundt's tube, plexiglas

For demonstrating standing waves and determining the wavelength of sound in air. Equipped with millimeter scale and movable piston for



Item: 247610

Singing tube

Sliding the hose around in circles produces a tone of airflow past the pipe mouth. If the hose is spun faster, a higher pitch will be achieved at a certain speed. Up to 5



Item: 247620

Musical tubes

Set of 8 brightly colored plastic tubes that form a C scale. Using the included end caps, the notes can be lowered an octave. From 30 to 60 cm long.



Item: 248200

Clapper board

Made of 2 hinged hardwood blocks To measure the speed of sound you can use: Folding tree (248200), 2 microphones



Item: 248600

Microphone

This is Frederiksen's self-developed microphone in a version with a flexible cable connection. The microphone is therefore delivered without a cable. It can i.a. used for



Item: 248601

Cable DIN 6 to modular

When used with the microphone



Item: 250310

Student function generator

This function generator is developed and produced by Frederiksen and is suitable for e.g. experiments with standing waves or for studies of sound waves at different



Item: 250350

Function generator

Developed and manufactured by Frederiksen, this function generator is suitable for experiments with standing waves or for studies of sound waves at different



Item: 264800

Gasoline cannon with lighter

This equipment is used to demonstrate the thermal forces of exploding hydrocarbons. The tube is made of Plexiglas and the bottom is fitted with a



Item: 264900

Pneumatic lighter

To demonstrate temperature rise when a confined volume of air is compressed. If a flammable material is placed in the transparent cylinder, it will ignite when the piston is



Item: 266020

Bar-breaking apparatus

To illustrate length expansion when heated and contraction when cooled. Supplied with 10 cast iron rods that burst when the



Item: 266025

Bars for bar-breaking apparatus

Pack of 50 cast iron bars for bolt cutters with order no. 266020
Dimension: 4 x 80 mm

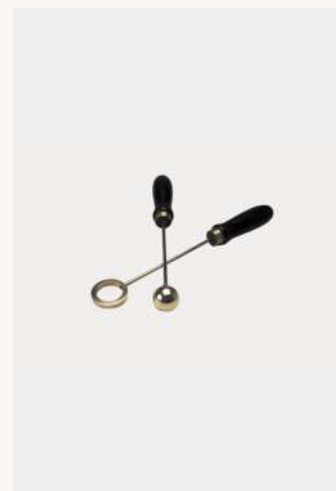

Item: 266500

Ball and ring

To demonstrate the expansion of solid bodies when heated. Consists of a brass ring mounted on a plastic handle



Item: 266905

Stirling engine with glass cylin

The Stirling engine is a piston engine where, unlike a traditional engine, combustion takes place outside the cylinder. The Stirling engine converts heat differences into



Item: 266910

Glass Stirling engine

Model of Stirling engine, with piston block made of glass to clearly show how the engine works. The engine is equipped with measuring pads for high and low



Item: 266925

Stirling engine, low temperatur

Simple stirling motor that works at very small temperature differences. A cup of hot water (must be above about 60°C) can make the motor run. Water heated



Item: 268500

Circulation pipe

To demonstrate circulation in a pipe system as a result of heating. Fill with water and sawdust. When heated at one end of



Item: 269000

Material samples

Material set consisting of aluminum, nylon, glass, rubber, iron, copper and brass. Each rod has a volume of 2



Item: 269500

Crooke's radiometer

This radiometer can be used to demonstrate that radiant energy (e.g. heat) can be converted into kinetic energy. It consists of a cross with 4



Item: 269510

Crooke's radiometer, double

Demonstrates the conversion of radiant energy into kinetic energy. The 2 crosses have opposite directions of rotation.

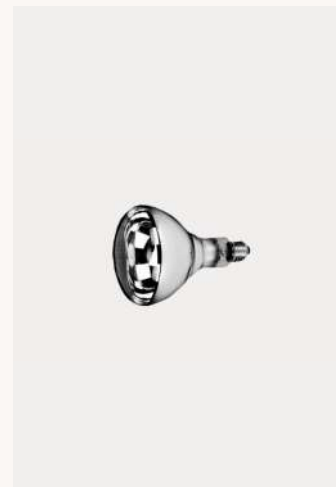

Item: 287500

Infrared lamp

230 V/250 W infrared lamp with E 27 base. Lamp diameter: 120 mm



Item: 288700

Optical fibre

Flexible light guide where the material allows light transmission of curved paths. Can direct any light to the desired location. Easy to cut to the desired length with a



Item: 288750

Laser optics set

With this kit the following topics can be investigated: Michelson interferometry, diffraction from gratings, mixers etc. and polarization of light.



Item: 288780

Green Diode Laser with Power

Green laser Equipped with key switch. At the bottom there are threads for clamping pins. Wavelength: 532nm (YVO₄) <



Item: 288790

Laser ray box with 5 rays

The Laser Ray Box is a 5-beam laser with magnetic backing that sends different, parallel light beams across the entire line. Choose between one, three or five



Item: 290100

Lens, Set

This prism set consists of 7 different prisms made of clear acrylic for use in optical experiments. Prism blocks all have a width



Item: 290201

Lens and aperture holder

Supports separate lenses or membranes with a diameter of 50 mm or a 50 x 50 mm plate. The support itself is 80 x 72



Item: 290300

Lens set, Ø 50 mm, FL (Concav

The kit consists of 6 Ø 50 mm loose lenses. The lenses can be mounted in lens and aperture holder 290201. The lens set can be used for



Item: 290310

Set of Mirrors, Convex / Conc

2 unassembled mirrors, concave and convex. Diameter: 50 mm. Width: +/-100 mm.</p>
</div>

export.frederiksen-scientific.com/

Viaduktvej 35
6870 Ølgod
+45 7524 4966
export@frederiksen-scientific.com

All prices are excl. VAT. Please note that there may be printing errors, price corrections and sold out items.

Copyright 2025

Frederiksen Scientific A/S

88



Item: 293500

Optics set with light box

Our classic optics kit - The kit can be used in regular classrooms as most experiments can be performed without the need for a blackout. The equipment

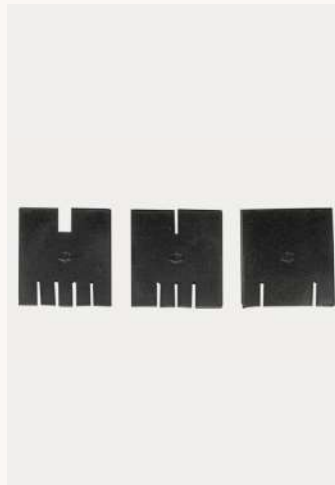

Item: 293504

Aperture Set, Spares for 2935

This slit set is extra plates for optics set 293500.



Item: 293600

Optics set with lenses and light box

An affordable version of the well-known optics kit and indispensable in optics teaching. The light box requires a 12V power source (NOT included) either via a



Item: 294000

Optics Set with Lenses

Quality set from Kvant. If you don't already have magnetic prisms and mirrors, this set is ideal for use with the Laser Ray Box (see related items). You'll find 14 different prisms,



Item: 294100

Optics set with laser ray box

An inexpensive and complete optics kit with prisms in different shapes, including an LED laser. The kit can be used to



Item: 294200

Laser ray box with lens set

This affordable optics kit includes a mini laser with accessories to perform experiments with concave and convex lenses. Also included is a plate for reading



Item: 294600

Optical bench with saddles

Optical bench for mounting light sources, lenses, prisms, apertures and similar in a stable position. The profile rail is made of black aluminum and equipped with



Item: 294610

Saddle, with Ø10 mm hole

For clamping equipment with max. Made of black painted metal with measuring line and thumbscrews. Dimensions: 35 x 50 x 84 mm. Weight: 150



Item: 294630

Base for optical bench

Accessory for optical bench 294640. Cross base with adjustable set screws with locking device and rubber foot. Made of black lacquered aluminum. Supplied with



Item: 336010

Hacksaw blades, short

Metal blades for magnetization experiments. Pack of 10 pieces Length: 153 mm.



Item: 339000

Plates for experiments in mag

Metal set with 7 x plates for use in experiments with e.g. magnets or for studying the conductivity of metals. The plates are made of brass,



Item: 339610

Magnetic field, demonstration

For demonstration of magnetic fields, in both 2- and 3-dimensions. The kit consists of a magnetic field box and a magnetic field



Item: 339620

Magnetic field plate with iron

To demonstrate 2-dimensional magnetic field. Place a magnet on the magnetic field plate and the iron filings align with the magnetic field lines.



Item: 341000

Compass needle

Stainless steel magnetic needle with nickel-plated brass bearing, which provides very low friction and thus free movement for the needle.



Item: 341500

Stand for compass needle

Non-magnetic metal support with steel tip on stable base. Foot diameter: Ø 41 mm. Height: 85 mm.



Item: 641602

Soft insulated cable, Ø0.14 mm

14 mm² soft yellow plastic insulation with 18 x 0.1 mm tinned copper wires. Supplied on a 200 m roll.



Item: 670138

Plasma ball, large

This plasma glass sphere consists of a small amount of noble gas, which by ionization can be used to show what a static discharge in a gas looks like. The ionization is



Item: 409645

Miniature fuse, 32 mm, 10 A, F

10m extension cable that connects to a and Type K cables e.g. 260653 or 2660650.



Item: 435000

Terminal post, uninsulated

Ø 10 mm nickel-plated and uninsulated stud terminal with insulated terminal screw. Provided with connection sleeve for safety wires.



Item: 435010

Terminal post, insulated, pair

Insulated pole clamp for mounting cables etc. The product is supplied in pairs. Equipped with Ø 30 mm



Item: 439000

Rubbing cloths, felt

Rubber for rubbing bars. Material: Felt piece. Dimension: 20 x 20 cm.



Item: 439021

Rubbing cloths, rabbit fur

Used to generate static electricity by rubbing. Dimension: approx. 20 x 10 cm



Item: 708410

Stand for soldering, iron

Soldering iron holder formed by a strong spring on a metal holder so that heat can be well dissipated. There is a soldering sponge

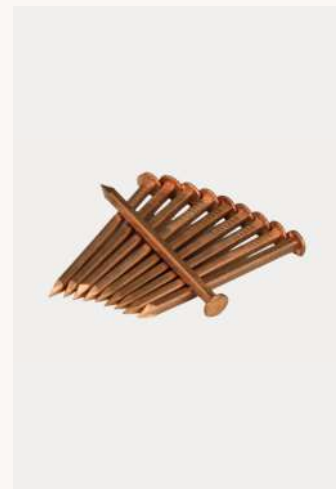

Item: 451700

Copper nails

Square solid copper nail with tip. Length: 65 mm Cross section: 3 x 3 mm



Item: 452000

U-tube with salt bridge

U-tubes with salt bridge are used in electrolysis, where different electrolytes are used for the two electrodes. Can also be used for fuel cell experiments. Fits round



Item: 700131

Screwdriver, 4 mm

Flat screwdriver 4 mm for small electronics screws with saw cuts.



Item: 298500

Newton's prism

Made of glass with polished surface.
Triangle side: 34 mm
Height: 35 mm



Item: 298515

Prism, right-angled

Rectangular with sides: 40 and 54 mm.
Height: 40 mm.



Item: 305510

Projection screen, white

Made of 2.5 mm matte white laminate board. Equipped with Ø 10 mm clamping pin. Screen size: 250 x 250 mm.



Item: 267000

Bimetallic strip

Provided with notch for clamping under clamping screw.
Dimension : 0.5 x 10 x 150 mm



Item: 272410

Heating pad

To demonstrate melting and solidification heat.
When the seal is activated, the sodium acetate content solidifies, raising the



Item: 272502

Specific heat cylinder, Alumin

Heat filling solder.
Material: Aluminum.
Dimensions: Ø30 x 61 mm.
Weight: 100 g.



Item: 274010

Joule's law apparatus

This device is used together with a calorimeter (274050) for the verification of Joule's law. The device consists of a lid for the calorimeter with a stirrer and a hole for a



Item: 278000

Steam engine D16

WileSCO steam engine with glass-polished brass boiler with a diameter \varnothing 55 mm, length 135 mm, boiler capacity 320 cm³ and with water level glass.



Item: 278500

Accessories for WileSCO steam engine

In connection with the use of the steam machine, it is possible to connect equipment.

Contains: Drilling machine



Item: 278501

Dynamo with bulb

Accessory for steam engine 278000. When this dynamo is connected to the steam engine with a strap, kinetic energy is transformed into electrical energy - the bulb



Item: 278510

Drive belts

Traction coils for steam engine with order no. 278000.

Length: 260 mm.
Diameter: \varnothing 2 mm.



Item: 278705

Oil for steam engine

Filling oil for steam engine 278000.



Item: 280130

Halogen flood light 120 W

Halogen lamp suitable for use with solar cells.

230 V mains voltage with a 120 W Halogen bulb.
Supplied with pole but without



Item: 280135

Halogen flood light 350-400

Halogen lamp suitable for use in experiments with e.g. solar cells.

230 V mains voltage with a 400 W Halogen bulb.



Item: 280612

Torch with 9 LEDs

Flashlight with 9 LEDs. The flashlight is approximately 9 cm long. Uses three AAA batteries (351004), sold separately.



Item: 280641

Torch, LED

Flashlight with a single powerful LED diode. Low power consumption and low weight. Made of hard plastic and equipped with nylon



Item: 283650

Spectral lamp with screw fittin

These spectral bulbs with screw base are used for demonstrating spectral lines. Please note that the screw base fits in a standard E27



Item: 336500

Iron nuts

Used for hanging magnets for experiments. Pack of 10 pieces. Hexagon nut 5/16"~(0.8 d UNC steel 8).

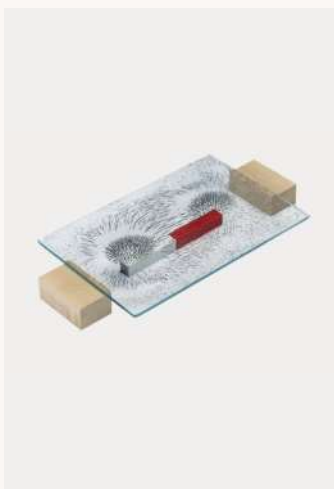

Item: 337500

Iron filings

Used to display magnetic field lines. Plastic straw bag contains 225 g iron filings. (total weight 250 g).



Item: 338500

Iron nails, 25 mm

Iron nails that can be used for magnetic testing, among other things. Length: 25 mm. Weight: 0.5 kg.



Item: 338510

Iron nails, 55 mm

Iron nail, which can be used for magnetic experiments, among other things. Length: 55 mm. Weight: 2 kg.



Item: 338530

Iron nails, 100 mm

Iron nails that can be used for magnetic testing, among other things. Length: 100 mm. Number: 210 pcs.



Item: 708411

Loose sponge for Weller

Replacement sponge for weller soldering station



Item: 647515

Solder roll

Roll loddetin 500g, lead-free.



Item: 425005

Bulb, 1,5 V, 0,09 A

Traditional incandescent bulb with E10 socket.
Voltage: 1.5 V.
Current consumption: 0.09 A.



Item: 440000

Pith balls

Flamingo balls Ø 12 mm balls (expanded polystyrene).
Used for the investigation of electrical charges.



Item: 752000

Lamp holder, E10, plastic moun

Supplied without bulb and solder tabs.



Item: 752010

Lamp holder, E10, with bracket

E10 lamp holder with solder lips. Equipped with two screw holes for surface mounting.



Item: 670118

Weight set with hook 50 g

Pack of 10 weights of 50 g.

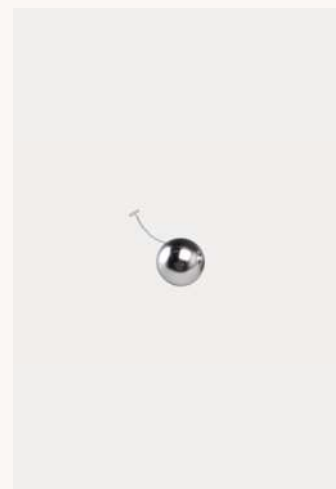

Item: 440500

Metallised ping pong ball

Used for transferring and examining electrical charge. Supplied with suspension in thin nylon thread. Dimension: Ø 38 mm.



Item: 441500

Ball on insulated rod

Used for transferring electrical charge.
Ball diameter: Ø38 mm.
Bar: Ø10 x 130 mm.
Weight: 14 g.</p>
</div>

Item: 442800

Conductor sphere, 68 mm, wit

For electrostatic experiments - for example, investigating the capacity of a sphere.
The kit consists of an 80 mm sphere with a Ø 4 mm

Item: 443000

Electric whirl

To demonstrate the effect of electric charge and spikes. The mill rotates freely on a needle placed on top of the tape generator.

Item: 443510

Insulated stool

Used for static electricity experiments where you want to isolate a person or object. Made of 10 mm acrylic. Dimension: 304 x 310 x 83

Item: 298550

Prism, glass

In optical glass. Equilateral. For experiments with light. Dimensions: (Side/height) 42 mm/32 mm.

Item: 649010

Edding 400, Permanent Marke

Highlighter Edding 400, well-known, solid marker that writes on almost any surface.

Item: 301005

Aperture with 7 vertical slits

Iris mounted in glassless slide frame. Fits in aperture holders 295080 and 297000. Number of slits: 7.

Item: 301020

Aperture with "F"

Gap width 1 mm. Used as an aperture where it can be demonstrated whether the image is inverted.

export.frederiksen-scientific.com/

Viaduktvej 35
6870 Ølgod
+45 7524 4966
export@frederiksen-scientific.com

All prices are excl. VAT. Please note that there may be printing errors, price corrections and sold out items.

Copyright 2025

Frederiksen Scientific A/S

96



Item: 281000

Candles

Can be used for optical experiments.
Diameter: approx. 12 mm.
Number: 20 pcs.



Item: 283660

Spectral lamp with screw fittin

To demonstrate mercury spectral lines.
Although the screw base fits into a standard E27 lampholder, under no



Item: 283670

Spectral lamp with screw fittin

For demonstration of neon spectral lines.
Although the screw base fits in a standard E27 lamp socket, under no



Item: 283675

Spectral lamp with screw fittin

For demonstration of helium spectral lines. (The lamp produces these primary lines in the spectrum; 588 nm, 668 nm, 707 nm).



Item: 284500

Balmer Lamp

For the observation and determination of the wavelengths of the hydrogen spectrum (Balmer series).
With water vapor filling to



Item: 284510

Power Supply for Balmer Lam

Spectral lamp holder for Balmer lamp (for 284500).
The Balmer lamp is not included in the control gear.



Item: 285000

Spectral tube, Ne

Used to demonstrate spectral lines for Neon (Ne) gas. The tube must be used with the spectral tube holder 285570, which also contains an adjustable power



Item: 285020

Spectral tube, H2

Used to demonstrate hydrogen spectral lines (H₂), the H₂ tube can be used to demonstrate Balmer series spectral lines. In non-noble gas spectral tubes,



Item: 285030

Spectral tube, He

Used for demonstrating Helium (He) spectral lines, the tube must be used with the spectral tube holder 285570, which also contains an adjustable power



Item: 285040

Spectral tube, Ar

Used to demonstrate spectral lines for Argon (Ar) gas, the tube must be used with the spectral tube holder 285570, which also contains an adjustable power



Item: 285050

Spectral tube, O2 (IR)

Used to demonstrate spectral lines for oxygen (O₂). Please note that the strong emission lines are in the IR range and therefore outside the visible range. The tube must be



Item: 285060

Spectral tube, Kr

Used to demonstrate spectral lines for the Krypton (Kr) gas. The tube must be used together with the spectral tube holder 285570, which also contains an adjustable



Item: 285070

Spectral tube, N2

Used to demonstrate spectral lines for the Nitrogen gas (N₂). The tube must be used with the spectral tube holder 285570, which also contains an adjustable power



Item: 285110

Spectral tube, H2O

Used for demonstrating spectral lines for water (vapor) (H₂O). The tube must be used with the spectral tube holder [285570](#), which also contains an adjustable power



Item: 285120

Spectral tube, CO2

Used for demonstrating spectral lines for carbon dioxide gas (CO₂). The tube must be used with the spectral tube holder [285570](#), which also contains an



Item: 285130

Spectral tube, Xe

Used for demonstrating spectral lines for the XENON (Xe) gas. The tube must be used with the spectral tube holder 285570, which also contains an adjustable power



Item: 285180

Spectral tube, Na and He

Used to demonstrate spectral lines for Sodium (Na). However, Na at room temperature does not have a vapor pressure high enough to be used in a spectral tube.



Item: 287110

UV lamp, battery-powered

Can be used to detect transformation of DNA in experiments 778221 and 778222, where a specific phenotype is clearly visible when illuminated with long



Item: 670172

Four-bladed propeller

The propeller fits a 2 mm motor shaft.
Diameter: 60 mm.



Item: 670179

Spring clip, universal

Plastic spring clamp for securing a small electric motor with a clamping range of 19 to 25 mm.
With self-adhesive base and



Item: 670180

Wooden splints

Wood pegs with a length of 220 mm and a thickness of 4 mm.
Packed per 100.



Item: 670182

4,5 V Electrical motor

Lightly powered motor (3 V – 6 V) for coupling with solar cell.
In no-load mode:
RPM: 14000.



Item: 640610

JACK, plug, 2-pol

Jack male connector mini, 2-pin, is a compact and reliable male connector, ideal for laboratory and electronics projects. With its 2-pin connection, this connector



Item: 640613

Jack Plug, Mini, 3-pin

Jack male connector mini, 3-pin, provides a robust and reliable 3-pin connection that is perfect for complex electronics and laboratory setups. This connector



Item: 218510

Piano wire ring

To be used with



Item: 218512

String holder

Spare part for the 218500 electromagnetic vibrator. String holder for attaching a string or spring to the electromagnetic vibrator in



Item: 218520

Chladni plates, square

Accessory part for the 218500 electric vibrator. The plate can be used in experiments that aim to demonstrate the sound patterns created at different



Item: 218525

Chladni plate, round

Accessory for [218500 Electromagnetic Vibrator](#). A thin layer of fine sand is spread over



Item: 218530

Flat springs f. resonance exper

Accessories for [218500 Electromagnetic Vibrator](#). Leaf springs of different lengths for resonance experiments. Fundamental



Item: 218540

Rubber string

Accessory for [218500 Electromagnetic Vibrator](#). 2 meter rubber cord for standing wave demonstration. Weight: 2.27 g.



Item: 218555

Gas model with piston

Accessory for 218500 Electromagnetic Vibrator. The steel balls illustrate molecules in different phases. Moving steel balls represent



Item: 221100

Ripple Tank incl. Vibrator

The basic properties of waves are the same whether they are water waves, sound waves or electromagnetic waves such as light. Therefore, the wave trough



Item: 221101

Stroboscope Unit, LED

Spare part for corrugated tub 221100. Supplied without mains adapter, item no. 355050.

Can also be used in an

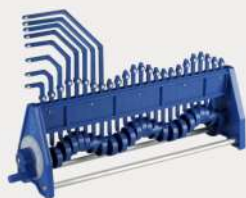

Item: 221200

Wave machine

For demonstration of longitudinal and transverse waves. The device is equipped with a camshaft with a handle that, while rotating, affects a series of



Item: 670054

Electronics tool set, 11 parts

11-piece tool kit.

The set contains :

- 30 W soldering iron
- Tin sucker
- Biting pliers



Item: 670055

Mounted buzzer

Makes a sound when power is passed through.

Can be used with both mini cables and safety cables.



Item: 670058

Push switch

Push switch, circuit breaker for both mini cables and safety cables.



Item: 670061

Multimeter

This multimeter is suitable as a student model. It has measurement ranges within; DC and AC voltage, DC current, resistance values, transistor test and diode test.



Item: 670065

Accessories for Van de Graaff

Accessory kit for the Van De Graaff generator 370060. The kit can be used to demonstrate how an electrostatic charge can be applied to other materials and



Item: 334500

Soft iron bar

Soft iron bar, nickel-plated - Soft iron is low-carbon iron that has a high degree of permeability, making it easy to magnetize and demagnetize. Soft iron is



Item: 425030

Bulb, 6 V, 0.1 A

Bulb with E10 fitting 6 volts at 0.1 amps. Packed per 10 pieces.



Item: 691010

Contact Adhesive

Contact adhesive in a 40 gram tube



Item: 222500

Tuning fork, 440 Hz, 120 mm,

Finished in nickel-plated steel with engraved pitch and frequency.
Frequency: 440 Hz
Length: 120 mm



Item: 425010

Bulb, 2.5 V, 0.3 A

Traditional incandescent bulb with E10 socket
Voltage: 2.5 V
Current consumption: 0.3 A



Item: 425035

Bulb, 6 V, 0.5 A

Bulb with E10 fitting 6 volts at 0.5 amps. Packed per 10 pieces.



Item: 425045

Bulb, 12 V, 0.25 A

Incandescent lamp with E10 socket.
Voltage: 12 V
Current: 0.25 A



Item: 701850

Screwdriver set

Combined screwdriver and bit set.
Contents:
7 x screwdriver, 4 x flathead and 3 x Phillips.



Item: 456502

U-magnet for 456500, Curren

Reserve part for power scale 456500.



Item: 304000

Glass plate, clear

Clear glass plate for mounting in plate holder no. 305000. Dimension: 180 x 120 mm, 2 mm thick.



Item: 670184

Gear wheels, various colours

The package contains 20 x 4 sprockets with 10, 20, 30 and 40 teeth and 20 x 75 mm racks. The sprockets fit a 4 mm



Item: 641320

Terminal block

12-piece terminal block for connecting cables with a maximum cross-section of 2.5 mm².



Item: 287125

UV-light, small, 400 nm

Micro UV flashlight with 1 UV LED. Mounted in keychain. Wavelength: approx. 400 nm



Item: 287145

UV beads (100 pcs.)

The beads are white in artificial indoor light, and become fluorescent in UV light due to phosphor reaction to UV radiation. We cannot guarantee that all beads will



Item: 336000

Hacksaw blades, standard

Made of magnetizable, hardened steel. Length: 313 mm Pack of 10



Item: 670255

ionizing material (rocks)

The kit consists of six different minerals containing uranium, thorium, yttrium, and/or cerium in various combinations and amounts. The minerals give weak to



Item: 670291

Project pack of 25 cars

Here we have put together a package with almost everything you need to build 25 cars. What you need in addition to

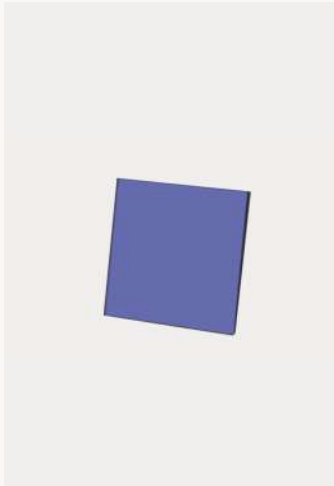

Item: 678000

Cobalt glass, 5 x 5 cm

Used to look at flame colors. If contaminated with sodium from e.g. fingerprints on the wire or magnesia rod used for the test, you may have



Item: 223001

Tuning fork, 145 mm

Made of nickel-plated steel with engraved pitch and frequency. Frequency: 440 Hz Length: 145 mm



Item: 224010

Tuning fork, wide, 1000 Hz

Aluminum tuning fork that, due to its high sound power, is suitable as a sound generator in experiments with resonance tubes or for demonstrating the Doppler



Item: 224520

Tuning forks on resonance bo

German quality tuning fork that can be used for resonance experiments and demonstration of shock tones.



Item: 224561

Striking hammer

Reserve part for tuning forks on resonance box ([224520](#) and [224530](#))



Item: 670074

Rocket balloons

Extra large and powerful balloons. They fly high with a powerful howl when the air is released. The balloons are



Item: 670076

Solar energy kit, 8 solar cells

Our 8 Solar Power Kit is the perfect way to learn about solar energy and experiment with electricity in a fun and interactive way. The kit contains 8 solar cells that can

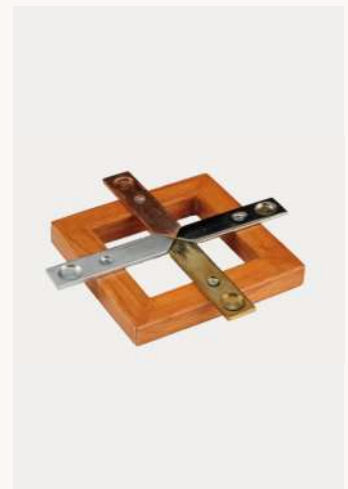

Item: 670081

Heat conduction device

This heat conduction apparatus is used to investigate the difference in the heat conduction of the metals iron, copper, aluminum and brass.



Item: 670084

Electricity case - 5 x Groups

This electricity kit is a good and space-saving solution for preliminary experiments with electricity.

The kit contains batteries,



Item: 670087

Neodymium ring magnets

Neodymium ring magnet.

Dimensions:

Inner dimensions 10mm.

Outer dimensions: 16mm.

<u5:p



Item: 670119

Weights with Hooks, Set

Set of weights with hook.

1 x1000 g, 1 x 500 g, 2 x 200 g, 1 x 100 g, 1 x 50 g, 2 x 20 g and 1 x 10 g.

Total 2100 g.



Item: 409033

Miniature fuses, 20 mm, 500

Melting fuse with glass tube 250 V, fine fuse.

Dimension: Ø5 x 20 mm.

Capacity: 500 mA.

Type: T (slow acting).



Item: 425100

Bulb, 12 V, LED

The LED bulb starts to glow dimly at about 3 V. Can be used up to 12 V.

Suitable for experiments with wind turbines or if you just



Item: 425110

LED bulb, 24V, E10, white

Durable and economical alternative to traditional incandescent bulbs. Can easily survive a trip on the floor.



Item: 426210

Halogen Tube, 120 W

Reserve part for Halogen lamp 2801230.

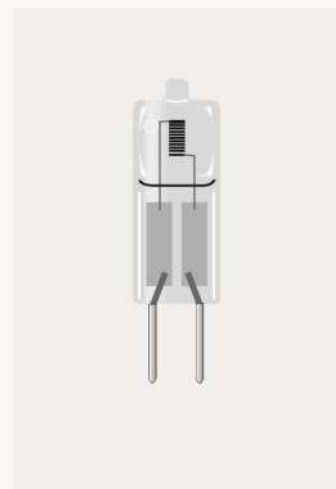

Item: 426555

Halogen bulb, 12 V, 25 W

Spare bulb for the light source in the light box included in light box set 293500.

Specifications:



Item: 428540

Energy ball

This very cool device consists of a 4 cm ball with two small metal electrodes. When the two electrodes are touched simultaneously, the ball flashes and makes a sound.



Item: 426220

Halogen Tube, 400 W

Halogen tube that can be used for Halogen lamp 400W - item number 280135.



Item: 599101

Teachers Guide to Sounds

Teacher's guide for Sounds and Sounds



Item: 459610

Spot Welding Tongs

Welding gun that can be used as a secondary coil (5x turns) on U-core 459610, and with a primary coil 459645. Outlet: Amperage: 360 A.



Item: 459640

Coil, 600 Windings, Demonstr

Coil for demonstration transformer, fits U-I core 4597.00. The coil is made of plastic with a square opening. The front plate indicates connection option, winding



Item: 459645

Coil, 600 Windings

Coil for demonstration transformer, fits U-I core 459700. The coil is made of plastic with a square opening. The front plate indicates connection option, winding



Item: 459650

Coil, 1200 Windings, Demonstr

Coil for demonstration transformer, fits U-I core 459700. The coil is made of plastic with a square opening. The front plate indicates the connection option, winding



Item: 459655

Coil, 24000 Windings

Coil for demonstration transformer, fits U-I core 459700. The coil is made of plastic with a square opening. The front plate indicates connection option, winding



Item: 459700

U-I core for demonstration coil

Height: 170 mm.
Width: 150 mm.
Cross section: 40 x 40 mm.
Weight: 6 kg.



Item: 459725

Clamping bracket for U-I core

Reserve part for demonstration coil 459700.



Item: 460220

Lenz Law kit, U-profile

Lenz's law is demonstrated in this device by rolling a magnet down a nearly vertical aluminum U-rail. This allows the movement to be followed all the way



Item: 471610

Hand dynamo, set of 2

Generator mounted in transparent plastic housing. With the help of a handle and gears, the generator can be made to deliver a power of up



Item: 471710

Bicycle dynamo, top can be di

Less bike dynamo 6 V / 3 W. The top can be unscrewed so it is possible to attach blades to a wind turbine.



Item: 472000

Motor, Unmounted, 2 - 6 V, DC

2-6 V DC electric motor
The motor can also be used as a generator. To power a 1.5 V, 90 mA incandescent lamp, a speed of



Item: 472001

Pulley for motor 472000

Pulley with Ø 2 mm center hole. Fits the shaft of [472000](#).
Pulley diameter: 16 mm



Item: 472002

Spring clip for motor 472000

Steel clamp with hole for clamping to plate. Fits engine [472000](#).



Item: 472005

Motor, Unmounted, 1.5 - 15 V

1.5 - 15 V DC motor. Quality motor with reasonable traction.

Can also be used as a generator.



Item: 472007

Pulley for motor 472005

Pulley with \varnothing 3.2 mm center hole suitable for the shaft of motor 472005.

Pulley diameter: 16 mm.



Item: 472015

Motor, mounted, 1.5 - 3 V

Motor mounted on a yellow plastic base.

Mini cables as well as safety cables can be used.



Item: 473500

Coil holder, three-phase

Included in model of 3-phase alternator.

Part number 473500 is **only** the holder for coils and laminated cores - for a

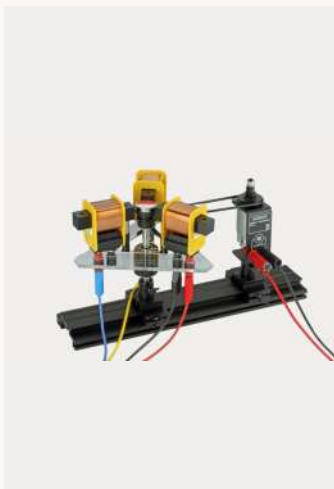

Item: 476050

Motor/generator set, three-ph

This kit serves as a model of an alternator. The kit consists of two parts, an induction unit with three coils and a round magnet, and a variable motor unit that rotates the round



Item: 487805

Superconductor, Meissner eff

Using a high temperature superconductor (HTSC), this kit demonstrates the most important magnetic property of superconductors called the Meissner effect, which was



Item: 488500

Solar cell with stand, 3 A

Large single cell, 100 x 100 mm, mounted in heavy-duty housing with clear acrylic front plate. Fitted with \varnothing 4 mm safety bushings and mounted on an inclined bracket that



Item: 488510

Solar cell with support post, 3

Large solar cell (single cell, 100 x 100 mm) as [488500](#), but mounted with \varnothing 10 mm 95 mm clamping rod. Equipped with \varnothing 4 mm safety bushings. Suitable for clamping in a



Item: 488511

Solar cell, 0,5 V, 130 mA

Solar cell built into a plastic enclosure, with clear glass front plate. Equipped on the back with screws for connecting cables.



Item: 488524

Solar panel with motor and propeller

Solar panel on pertinax plate molded in plastic with solder terminals, smooth-running motor with holder and two-wing propeller.



Item: 488525

Solar cell with aquarium pump

This water pump is powered by electricity produced by a small solar cell. The pump can also be used in cultivation experiments

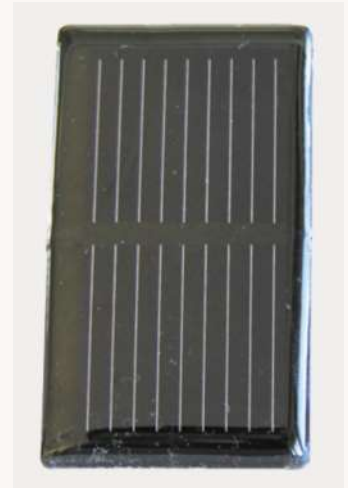

Item: 488530

Solar panel with screw terminals, 0,5 V

Suitable for investigating the significance of the area and number of cells and for measuring characteristics. Sealed solar cells with screw terminals on the back;



Item: 545920

Sugar prism

Simple method for determining the sugar content of solutions such as soft drinks. Using a number of stock solutions with known sugar content, you can make



Item: 462510

Coil for student transformer, 2

Coil for student transformer. Made of colored plastic with Ø 4 mm safety bushings. The coil is provided with a transparent self-adhesive



Item: 462517

Coil for student transformer, 2

Coil for student transformer. Made of colored plastic with Ø 4 mm safety bushings. The coil is provided with a transparent self-adhesive



Item: 462520

Coil for student transformer, 4

Made of colored plastic with Ø 4 mm safety bushings. The coil is provided with a transparent self-adhesive polyester foil with an effective breakdown voltage of more



Item: 462522

Coil for student transformer, 6

Coil for student transformer. Made of colored plastic with \varnothing 4 mm safety bushings. The coil is provided with a transparent self-adhesive



Item: 462525

Coil for student transformer, 8

Made of colored plastic with \varnothing 4 mm safety bushings. The coil is provided with a transparent self-adhesive polyester film with an effective breakdown voltage



Item: 462527

Coil for student transformer, 3

Coil to student transformer.

Made of colored



Item: 462530

Coil for student transformer, 1

Made of colored plastic with \varnothing 4 mm safety bushings. The coil is provided with a transparent self-adhesive polyester film with an effective breakdown voltage



Item: 462540

Coil for student transformer, 3

Made of colored plastic with \varnothing 4 mm safety bushings. The coil is provided with a transparent self-adhesive polyester film with an effective breakdown voltage



Item: 463000

U/I core

Laminated U-core with anchor and clamping screw. Fits student coils with item no. 462510 - 40.

Cross-sectional area: 20 x 20



Item: 463010

I-core, laminated

Lamellated I-core. Dimensions: 20 x 20 x 83 mm Weight: 225 g



Item: 514210

Extra absorber plates

Supplementary absorber plates for use with muon observatory Size: 148 x 148 x 3 mm in steel



Item: 516000

Chain reaction apparatus

To demonstrate chain reaction using matches. Includes 6 pins to dampen the chain reaction. For extra pins order item no.



Item: 464000

Galvanometer insert

To build a simple galvanometer for displaying induction currents. The insert consists of permanent magnet with pointer suspended in blade bearing.



Item: 465000

Helmholtz coils for e/m tubes

Helmholtz coils are mounted on a plastic plate with connection bushings. Consists of 2 single coils with 120 turns each, arranged plane-parallel at a distance of



Item: 516001

Extra pins, pack of 6

Extra pins for chain reaction device with no. 516000

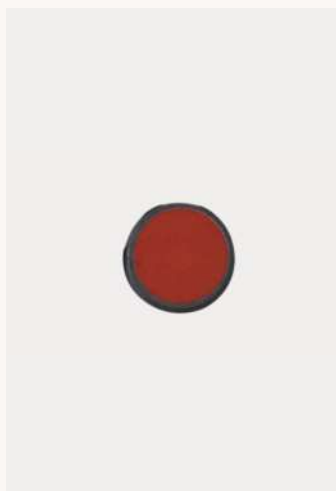

Item: 516100

Protons

To illustrate the stabilizing effect of neutrons on the atomic nucleus. The "protons" are made of disc magnets, while the

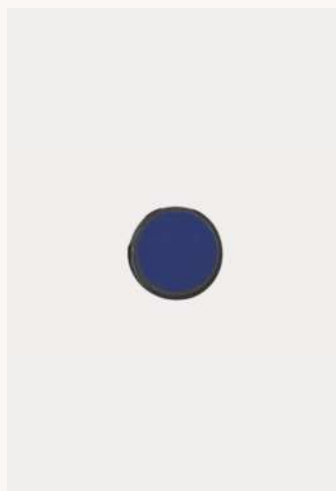

Item: 516110

Neutrons

To illustrate the stabilizing effect of neutrons on the atomic nucleus. The "protons" are made of disk magnets, while the

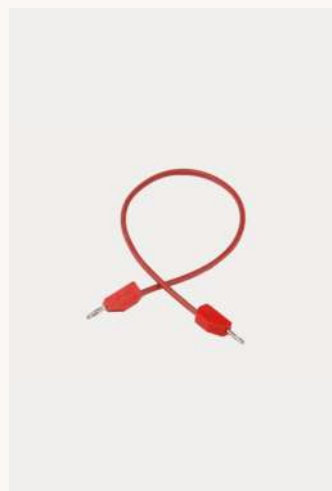

Item: 105111

Cables with 2 mm plugs, 25 c

Highly flexible silicone-insulated cables with Ø 2 mm connectors. Copper cross-section 0.50 mm², max 10 A. 30 V AC/ 60 V DC. Withstands temperatures up



Item: 109005

Uninsulated alligator clips

Uninsulated crocodile clips with Ø 4 mm hole. Bag of 10 pcs.



Item: 110025

Coaxial cable with BNC conne

HQ coax cable with BNC connectors on both ends.

Specifications

Cable type: RG58.



Item: 111100

BNC T-splitter

Adapter, BNC (male) to two BNC (female).

Used for example when an oscilloscope needs to display the signal from a function



Item: 117620

Silver wire, Ø0.50 mm

Silver wire can be used in physics lessons for a variety of experiments and demonstrations.

Here are some examples:



Item: 148555

Sand Timer

Different hourglasses (with sand) used to show time.



Item: 161550

Flow Control System

The flow system consists of a water tank, variable speed pump, a turbine type flow sensor, an electrically operated proportional valve and a variable flow meter (



Item: 161570

Pneumatics control with S7-12

This kit can be added to item number 161550 to explore robust industrial PLCs. The equipment can be used to investigate how the combination of a robust



Item: 208430

Statics fundamentals

This equipment is used to investigate forces, moment and deflection on beams. The student uses the work panel to construct a series of experiments, which provides



Item: 208505

Pulley wheel on a rod

50 mm pulley on bar with very low friction.
Total length of 250 mm.
Bar diameter: 12.5 mm.



Item: 208550

Dynamics fundamentals

This equipment investigates pulleys, static and sliding friction, mechanisms and energy conversion. The student uses a



Item: 209510

Pulley with clamp

Pulley with clamp for 10 mm bar diameter and a 50 mm pulley wheel.



Item: 210510

Pulley with eyes, double

Easy-running pulley pulley with 50 mm diameter pulley made of extra strong plastic. Equipped with a deep V-shaped groove to ensure that the cord does not easily slip



Item: 210610

Pulley with hooks, single

Plastic pulley, Ø 50 mm, with hook at both ends.



Item: 210620

Pulley with hooks, double

2 plastic pulleys, Ø 50 mm, mounted in block. Equipped with hooks at both ends.



Item: 210630

Pulley with hooks, triple

3 x plastic pulleys, Ø 50 mm, mounted in block and equipped with hooks at both ends. It can be used, for example, in experiments on the distribution of forces in a



Item: 210640

Tackle, three-part

3 plastic pulleys, Ø 50 mm, Ø 40 mm and Ø 30 mm, mounted in a row and equipped with hooks at both ends.

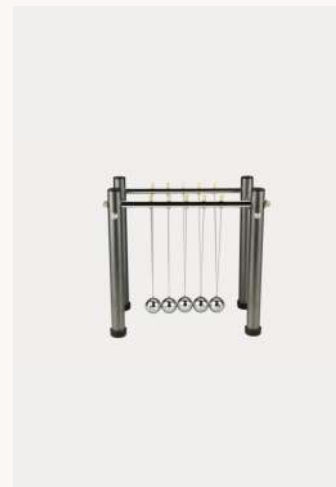

Item: 211530

Collission Balls, Big Size

Appliance for demonstrating Newton's 3rd law of motion - action and reaction are equal and opposite. It is also suitable for demonstrating conservation of



Item: 212125

Rocket, stomp model with 3 ro

Super fun and simple product. The harder you step on the air cushion, the higher the rocket flies into the air. The rockets have a soft rubber cap that won't damage



Item: 251565

Batterybox for microphones

The battery box is used to supply power to Frederiksen microphones with modular sockets when they are connected to equipment that *does not* provide its own



Item: 252800

Sound level meter, digital

Robust and easy-to-use decibel meter with 3-digit digital display. Measuring range: 35 dB - 130 dB with ±1.5 dB and choice



Item: 264710

Metal tin with lid 500ml

Used to show that the pressure of a trapped gas increases with increasing temperature. The can is made of



Item: 266050

Materials fundamentals

This equipment investigates torsion, stress and strain, elastic constants and Young's Modulus. The student uses the



Item: 287160

UV-lamp (230V)

This UV lamp emits ultraviolet light in the wavelength range 350 to 400 nm (UVA), with a maximum at 370 nm. Connects directly to the mains. Comes with on/off



Item: 294645

Optic rail 100 cm

Support rail 100 cm



Item: 299005

Prism table on rod

Table Ø 62 mm mounted on Ø10 mm clamping rod. Fits in line of sight with light source NL122147.



Item: 365580

Power Supply 500 V, 230V

This DC power supply delivers an output of three different stabilized DC voltages. All outputs are connected to a display



Item: 406055

Probe for 406060 Teslameter

Reserve part for teasel 406050 - replacement probe



Item: 422050

Variable resistor, 0 - 10 Ω

Encapsulated sliding resistor with safety bushings. The internal resistor is wound on a stable ceramic tube. The sliding resistor is



Item: 422060

Variable resistor, 0 - 33 Ω

Encapsulated sliding resistor with safety bushings. The internal resistor is wound on a stable ceramic tube. The sliding resistor is



Item: 422070

Variable resistor, 0 - 100 Ω

Encapsulated sliding resistor with safety bushings. The internal resistor is wound on stable ceramic tubes. The sliding resistor is



Item: 422080

Variable resistor, 0 - 330 Ω

Encapsulated sliding resistor with safety bushings. The internal resistor is wound on stable ceramic tubes. The sliding resistor is



Item: 422090

Variable resistor, 0 - 1000 ohm

Firing resistor encapsulated in a housing with safety bushings. The internal resistor is made of a wound oxidized constantan wire on a ceramic



Item: 425015

Bulb, 3.5 V, 0.2 A, 10 ps

Bulb with E10 suitable for 3.5 volts at 0.2 amps. Packed per 10 pieces.



Item: 425020

Bulb, 4 V, 0.3 A

Traditional incandescent bulb with E10 socket
Voltage: 4 V
Current consumption: 0.3 A



Item: 425025

Bulb, 6 V, 0.05 A

Bulb with E10 fitting 6 volts at 0.05 amps. Packed per 10 pieces.



Item: 425040

Bulb, 6 V, 1 A

Bulb with E10 fitting 6 volts at 1 ampere. Packed per 10 pieces.



Item: 425050

Light Bulb, 12 V, 0.1A

Incandescent lamp with E10 socket.
Max. incandescent voltage: 12 V
Max. Current load: 0.1 A



Item: 425060

Bulb, red, 3.5 V, 0.2 A

Red bulb with E10, suitable for 3.5 volts at 0.2 amps. Packed per 10 pieces.



Item: 425070

Bulb, yellow, 3.5 V, 0.2 A

Yellow bulb with E10, suitable for 3.5 volts at 0.2 amps. Packed per 10 pieces.



Item: 425080

Bulb, green, 3.5 V, 0.2 A

Dwarf lamp, green, for socket E10. 3.5 V/0.2A - e.g. for 1.5 or 3 volts.
Pk. with 10 pcs.

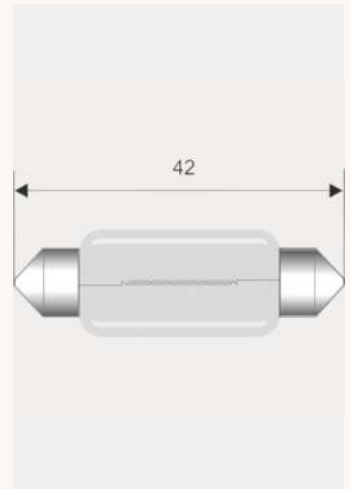

Item: 428000

Festoon bulb, 12 V, 15 W

Pinol lamp.
Voltage: 12 V.
Power: 15 W.
Socket: pinol.



Item: 428520

Discharge tube, Ø 13 x 100 mm

Neon filled glow lamp, for detection of electrical charge and polarity. Orange glow = negative pole.



Item: 504620

Propeller, 80 mm

5 x Propeller to fit a 2 mm rod. Propeller diameter 80 mm.



Item: 639160

Reflector lamp for colour mixi

Reflector lamp for color mixing. If a white canvas is illuminated with 3 lamps in the primary colors, we will perceive the light as white. By shading, turning lamps on

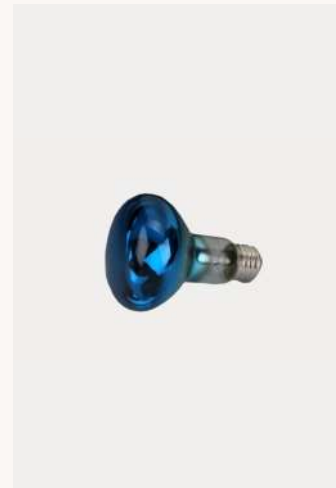

Item: 639162

Reflector lamp for colour mixi

Reflector lamp for color mixing. If a white canvas is illuminated with 3 lamps in the primary colors, we will perceive the light as white. By shading, turning lamps on



Item: 639165

Reflector lamp for colour mixi

Reflector lamp for color mixing. If a white canvas is illuminated with 3 lamps in the primary colors, we will perceive the light as white. By shading, turning lamps on



Item: 641747

Soft insulated cable, 0.50 mm

0.5 mm² soft wire (AWG20), 42m.



Item: 641748

Soft insulated cable, 0.50 mm

0.5 mm² soft wire (AWG20), 42m.

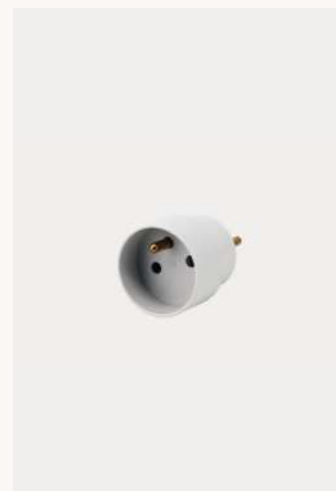

Item: 642525

Adapter for SHUKO mains plu

Adaptor plug - Male plug with three-pin to male plug schuko.



Item: 642550

Extension cable, 10 m (230V)

Extension cord, 10 m, ungrounded (230 V)



Item: 670177

Pulley set for motor 472000

Pulley set for engine 472000



Item: 752052

Pertinax washers

Pertinax rings as insulation material for E10 luminaires. Used with 752051 as insulator. Packed per 100.



Item: NL114712

Jack socket, 6 A, red

For 4 mm diameter plugs, each 6 A, insulated Red



Item: NL114920

Fundamentals of electricity

Locktronics LK6444 experiment kit for science and general engineering courses Introduction to electricity (10+ years)



Item: NL114924

Electrical and electronics prin

Locktronics LK9329 Electric and Electronic Principles Experiment Set (16-18 years) With this set an understandable range of



Item: NL114932

Intermediate electronic engine

Locktronics LK3889-2 experiment set for electrical and electronics training Basic electronics technology This set provides a broad



Item: NL114950

Electricity, magnetism and mat

Locktronics LK9071 Basic Electricity & Magnetism Kit. This starter kit offers a range of practical tests for electricity and magnetism and also



Item: NL114955

Basics of automotive electricit

This set of equipment covers the electrical properties of materials, electricity and electrical circuits. The solution includes component holders, foot panel, power



Item: NL114957

7 x 5 metric baseboard with 4

Mounting plate with 4 mm connector

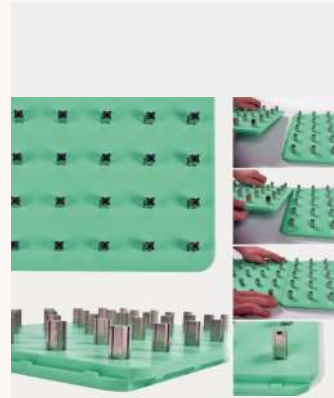

Item: NL115016

Baseboard, 7x5, 4-mm pillars

Contact plate for components from locktronics system.



Item: NL115154

Light bulb, 12 V, LED, white

LED Bulb, 12 V, white



Item: NL115171

Light bulb carrier, E10

Locktronics LK5291 switching element with lamp holder, E10.



Item: NL115175

LED, red

This red LED is mounted on a solid plastic plate with clear symbolism and integrated resistor, making it particularly suitable for use in science and technology lessons. No



Item: NL115234

SE resistor, 120 Ω, 1/2 W, 5%

Locktronics LK5206 SE resistor, 120 ohms, 1/2W, 5%



Item: NL115249

Thermistor, 470 ohm, NTC

Locktronics LK5401 switching element with thermistor, 470 Ohm, NTC



Item: NL115261

Potentiometer, 250 ohm

LK5208 - SE potentiometer, 250 ohms



Item: NL115270

Diode, germanium

LK5242 - SE diode, germanium



Item: NL115285

Power transistor, NPN, 10 A

Based on high power NPN transistor 2N3055. 'Left hand feed' refers to the base being on the left side of the holder when the emitter is bottom right, collector top



Item: NL115312

Switch, changover, metal strip

LK6208 - Toggle, switch, metal strip



Item: NL115313

Switch, on/off, metal strip

Locktronics LK6209 switching element with switch, on/off, strip.



Item: NL122175

Plate with 1 and 2 slits

Diaphragm for light source NL122147 from optics kit NL112110, with 1 and 2 slots
Size 56 mm x 56 mm x 1.75 mm



Item: 352450

Battery-charger for 4 x -AAA

Battery charger with high-quality LCD display showing the charge.

Specifications:



Item: 639601

Alligator 2 mm clips, w. cloak.

Insulated 2 mm crocodile tag with black plastic sheath and a length of 48 mm.



Item: 660110

Makey Makey STEM Pack: Cla

MaKey MaKey connects to your computer via USB and you use the included alligator clips to connect almost anything you want to give input to your computer. Why



Item: 670062

Energy meter with power plug

This energy meter makes it possible to measure the energy consumption of electrical appliances over a period of time.



Item: 287141

UVC bulb, 15 W, E27 socket

15 Watt UVC bulb (darklight) suitable for E27 socket (for 230 V) with a wavelength of **254nm**.



Item: 670063

Peak tech - Energy meter, w. P

The PeakTech 670063 is a high-precision energy cost meter for recording the energy consumption of electrical devices and for calculating the power



Item: 324505

(Paton Hawksley) Diffraction g

Grid copy mounted between 2 glass plates 50 x 50 mm in slide frame.

Grid area: approximately 25x 25



Item: 452871

New fuel cell for fuel cell kit 4

New fuel cell for fuel cell kit 452870



Item: 208560

Mechanics platform

This complete set of equipment allows students to understand the principles of basic statics, materials and dynamics engineering systems in one portal set of



Item: 507015

Franck-Hertz Apparatus - Neon t

The Franck-Hertz tube is a tetrode with an indirectly heated barium oxide cathode K, a mesh-type guide grid, a



Item: 258000

Doppler effect on air cushion

This equipment package makes it possible to work experimentally and quantitatively with the Doppler effect:



Item: 212104

Spare part - Pressure hose for

Extend the life of your ROKIT water rockets. This yellow pressure hose is a spare part for the Original Water Rokit and NASA series. It is used to connect the pump and rocket



Item: 212106

Spare part for Rokit - Steering



Item: 212114

Rokit set - Moon mission

Take education to the moon - literally.

The Moon Missions edition of the Water Rokit is part of the official NASA series and



Item: 212115

Rokit set - NASA Mars expedite

Mars Exploration is part of the official NASA series of Water Rokit rockets and brings space right into the schoolyard. The rocket works like the other Rokits - using



Item: 212107

Spare part for Rokit - Steering



Item: 212108

Spare part for Rokit - Steering



Item: 212119

NASA Mission Stickers - 3 sheets

Decorate your Rokit rocket ready for the next mission. This set contains 3 sheets of official NASA Mission Patch stickers:



Item: 212111

Rocket, Rokit without bottle (R)

Take education to the moon - literally.

The original Water Rokit combines engineering, physics and imaginative

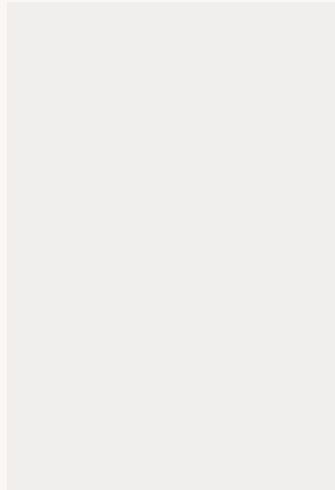

Item: 212112

Rokit starter kit (ROKIT-CK)

Rokit starter kit - unpack, add water and be ready to lift off.

Rokit is a precision water rocket, perfect for use in schools and colleges or by

Chemistry

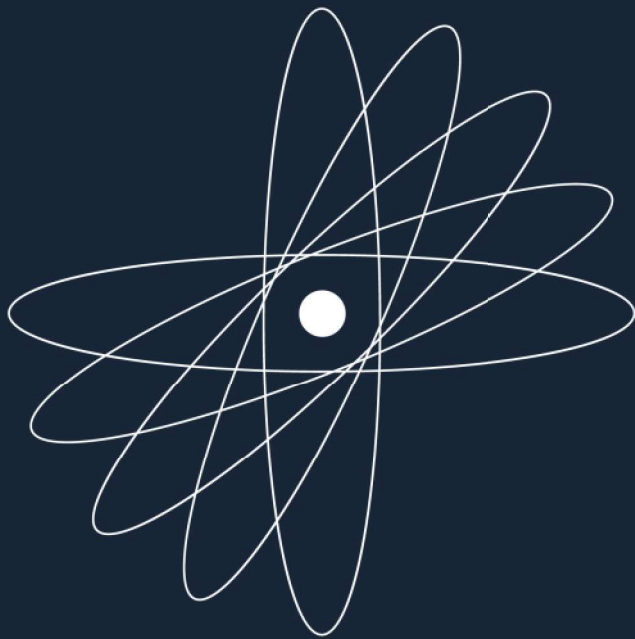



Item: 084020

Protective Screen, 3 Leaf

3-wing Plexiglas screen 880 x 600 mm with 2 x 440 mm hinged wings.
Sheet thickness 4 mm.
Free-standing.



Item: 084500

Faceprotection

Face shield made of unbreakable clear plastic with metal reinforcement.
Holder with sweatband and tilt bracket and adjustable



Item: 085000

Safety Goggles, standard

Goggles made of clear impact-resistant plastic. Can be used on top of regular glasses.



Item: 085010

Safety Goggles, Close-Fitting

Fashionable lightweight glasses. Good fit. Built-in side shields and unlimited field of view. Anti-fog and anti-scratch lenses. Surface hardened polycarbonate.



Item: 085510

Protective apron in cotton/nyl

Cotton/nylon protective apron with pocket and sewn-in ties.
Color: dark blue Size: 97 x 73 cm



Item: 085525

Protection Apron, black

Strong protective apron in black oilcloth. Sewn with folded edge with inlaid hem.
Length: 90 cm Width: 70 cm
Free hem length: approx. 80



Item: 085640

Laboratory Coat, Size XXL

White lab coat in 65% polyester / 35% cotton in good quality. The lab coat is equipped with press studs and has 2 external side pockets and 1 external chest



Item: 086030

Heat-resistant gloves, pair

Heat protective glove designed as a mitten with heat-insulating materials.
Max. 400 °C.



Item: 085020

Safety glasses with neck strap

Lightweight model with side protection and neck strap, also suitable for younger students. Can be used without regular glasses.



Item: 085500

Protection Apron, Plastic

Protective apron in heavy-duty PVC with ice-welded rings and fabric ties. Color: Blue. Size: Adult, 80 x 110 cm



Item: 085503

Protective Apron, Plastic, Chil

Protective apron in heavy-duty PVC with ice welded rings and fabric ties. Color : Blue. Size : Child, 65 x 80 cm



Item: 085676

Laboratory Coat, Size L

White lab coat in 65% polyester / 35% cotton in good quality. The lab coat is equipped with press studs and has 2 external side pockets and 1 external chest



Item: 085700

Bench Surface Protection Pap

"LAB-TOP". Absorbent filter paper coated on the underside with an impermeable layer of polyethylene. Protects the worktop against acids, alkalis



Item: 085672

Laboratory Coat, Size S

White lab coat in 65% polyester / 35% cotton in good quality. The lab coat is equipped with press studs and has 2 external side pockets and 1 external chest



Item: 085674

Laboratory Coat, Size M

White lab coat in 65% polyester / 35% cotton in good quality. The lab coat is equipped with press studs and has 2 external side pockets and 1 external chest



Item: 085060

Safety goggles for UV protecti

Safety glasses in impact-resistant plastic with filters that protect the eyes from harmful short-wave UV rays.



Item: 085450

Disposable Aprons, White, LD

Disposable apron in dispenser box. Fits in most glove holders.

Plast thickness: 18 micron
Dimensions: 80 x 125 cm



Item: 086046

Nitrile Gloves, Small

Nitrile gloves have good chemical resistance and are highly elastic. The gloves have the same good fit as latex gloves, but do not contain powder, which



Item: 086047

Nitrile Gloves, Medium

Nitrile gloves have good chemical resistance and are highly elastic. The gloves have the same good fit as latex gloves, but do not contain powder, which



Item: 086048

Nitrile Gloves, Large

Nitrile gloves have good chemical resistance and are highly elastic. The gloves have the same good fit as latex gloves, but do not contain powder, which



Item: 086049

Nitrile Gloves, X-Large

Nitrile gloves have good chemical resistance and are highly elastic. The gloves have the same good fit as latex gloves, but do not contain powder, which



Item: 086050

Work gloves

Flexible general purpose work glove in fabric and synthetic leather with elastic back.
Size: medium



Item: 067411

Centrifuge Tube Conical, Ø17 x

Centrifuge ungraded in AR glass (soda glass) with conical shape. Without collar.
Dimension: Ø 17 x 112 mm.



Item: 086100

Fluorescent disclosing lotion,

Are hands clean after washing?
Have students smear fluorescent cream on their hands before washing and



Item: 086530

Eyewash in 1 L bottle for 0865

Sterisol eye wash containing sterile isotonic sodium chloride solution 0.9%, with improved dust-proof cap and opening mechanism.



Item: 086800

Dust mask, FF P2

Robust dust mask with strong elastic that is well attached to the mask. Approved for hazardous fine dust (class FF P2). Extremely low breathing resistance. Foldable and easy



Item: 087500

Forbindingskasse med indhol

First aid kit containing equipment for treating minor injuries. Contains various sterile and compression bandages, plasters, arm sling, scissors, tweezers,



Item: 087502

Complete filling for first aid kit

Complete filling for first aid kit



Item: 088020

Skilt, trykflasker, selvklæbend

Yellow warning sign "Remove pressure cylinders in case of fire". Self-adhesive plastic film, dimensions 210 x 297 mm (A4 size)



Item: 088075

Skilt, brandfare, selvklæbende

Yellow warning sign "Fire hazard". Self-adhesive plastic film, side length: 160 mm.



Item: 088080

Skilt, giftpare, selvklæbende

Triangular plastic label to stick on a smooth surface.



Item: 088085

Skilt, øjenværn, selvklæbende

Blue injunction sign "Eye protection mandatory". Dimensions: 148 x 210 mm (A5 size).



Item: 088095

Electrical hazard warning sign

Electrical control rooms are rooms that are only accessible to trained or authorized personnel. We have produced a self-adhesive warning sign in A4



Item: 091700

Balance with weights

Quality bowl scales in hard plastic – an ideal tool for learning about weight and density. These robust scales are designed for teaching and experiments where students



Item: 095530

Weights set

Set of 16 weights from 50g to 10mg (50g-20g-2x10g-5g-2x2g-1g and 500mg-2x200mg-100mg-50mg-2x20mg-10mg).



Item: 095660

Calibration weight, 50 g

50 g calibration weight



Item: 095670

Calibration weight, 100 g

100 g calibration weight



Item: 095680

Calibration weight, 200 g

200 g calibration weight



Item: 095690

Calibration weight, 500 g

500 g calibration weight.



Item: 097300

Weighing pan, plastic 60 x 80

Romb-shaped weighing bowl in white polystyrene (Kartell).
Dimension: 56 x 78 mm
Depth: 14 mm



Item: 097350

Weighing paper, 90 x 125 mm

Ultra-thin weighing paper in glassine.
Dimension: 90 x 125 mm



Item: 085900

Chemical spill kit

Set for collecting small spills. Contains 10 suction mats and 2 containment socks (120 x 8 cm). The kit can absorb a total of approx. 13 liters.



Item: 086010

Gloves, Vinyl, PVC

A strong and pliable vinyl glove. Resistant to oil and household chemicals.
Size: adult.
OBS: PVC waste must be



Item: 086014

Nitrile Gloves, Green, XL, Size 1

Protective glove made of synthetic rubber. Resistant to most chemicals. Smooth surface and provided with velour coating on the inside.



Item: 086015

Nitrile Gloves, Green, L, Size 9

Protective glove made of synthetic rubber. Resistant to most chemicals. Smooth surface and provided with velour coating on the inside.



Item: 086016

Nitrile Gloves, Green, L, Size 8

Protective glove made of synthetic rubber. Resistant to most chemicals. Smooth surface and provided with velour coating on the inside.



Item: 086017

Nitrile Gloves, Green, S, Size 7

Protective glove made of synthetic rubber. Resistant to most chemicals. Smooth surface and provided with velour coating on the inside.



Item: 086021

Gloves, Disposable, PE, M, 100

Disposable glove in clear polyethylene. Size : medium



Item: NL119400

Tray, 225 mm, flame red

The Granells system tray is specially designed for school and laboratory use. The tray is made of extra strong polypropylene and is fire retardant and anti-static. The



Item: NL119402

Tray, 225 mm, sunshine yellow

The Granells system tray is specially designed for school and laboratory use. The tray is made of extra strong polypropylene and is fire retardant and anti-static. The



Item: 038510

Plastic tubing, clear, Ø3/5 mm

Plastic hose in clear PVC. Length: 5m. Inner/outer diameter: 3/5 mm



Item: NL118367

Round Filter, MN617, fast, Ø125

Round filter, fast, 125 mm diameter. Filter paper for quantitative analysis. Macherey-Nagel type MN617



Item: 005200

Ethanol burner, DURAN, 100 m

Classic ethanol burner from DURAN made of durable soda-lime glass, perfect for precise laboratory tasks. This ethanol burner comes



Item: 038515

Plastic tubing, clear, Ø5/7 mm

Plastic hose in clear PVC. Length: 5 m. Inner/outer diameter: 5/7 mm



Item: 038520

Tube, PVC, Ø9/6 mm

Plastic hose in clear PVC. Length: 5m. Inner/outer diameter: 6/9 mm



Item: NL117165

Distillation apparatus, 100 mL

Complete distillation apparatus made of one-piece Duran glass. Consisting of a 100 ml distillation flask with a Liebig



Item: NL117350

Centrifuge tubes, 1.5 mL, 1000

Eppendorf tube with hinged lid

Dimensions are: Length with open lid: 39 mm Length with closed lid: 41 mm Tube



Item: NL117443

Plastic funnel, powder, 150 m

Semitransparente pulvertragte udført i polypropylen, og med bredt udløb; sætningen kan anvendes til pulver eller



Item: 038525

Plastic tube, transparent, Ø10/

Plastic hose in clear PVC. Length: 5m. Inner/outer diameter: 10/14 mm



Item: 038526

Silicon tubing, Ø3/5 mm

Plastic hose in silicone. Length: 5 m. Inner/outer diameter: 3/5 mm



Item: 038528

Silicon tubing, Ø4/6 mm

Plastic hose in silicone. Length: 5m. Inner/outer diameter: 4/6 mm



Item: 038530

Tube, silicone, Ø8/6 mm

Plastic hose in silicone. Length: 5m. Inner/outer diameter: 6/8 mm



Item: 038550

Silicon Tubing, Ø8/12 mm

Plastic hose in silicone. Length: 5m. Inner/outer diameter: 8/12 mm



Item: 038580

Latex tubing, Ø 5/8 mm

Latex hose. Inner/outer diameter: 5/8 mm



Item: 039010

Tubing connector, Ø7-10 mm

Double conical hose collector. Made of impact-resistant acid-resistant plastic. Outer diameter \varnothing : 7-10/7-10



Item: NL119355

Gratnells storage frame, 3 col

System rack for stationary storage of trays. Supplied without trays, shelves and guide rails. The rack can be used in combination with all sizes of Gratnell



Item: 179001

Rubber stopper, 31/38 mm

For Glass Bell (178520)
Also suitable for:
012560: Test tube, \varnothing 38 x 200 mm, with collar
007910: Conical flask, 250



Item: 146805

Measuring spoons, 6 sizes, 1/8

Set of six measuring spoons varying in size 0.62 ml, 1.25 ml, 2.5 ml, 5 ml, 7.5 ml and 15 ml.



Item: 146900

Weights, cm³

Cubes with side length 1 cm (1 cm³) and weight 1 g. The dice have a hole and a tab to allow them to be assembled into larger units.



Item: 068510

Blower/suction ball

Red rubber ball - suction via the valve in the ball and discharge via the hose. The classic suction ball for pipettes and burettes when



Item: 069020

Water jet vacuum pump, plasti

Plastic pump made of polypropylene. Connection thread 1/2" and 3/4" pipe thread. Union nut with "O" ring. Equipped with



Item: 069030

Water jet vacuum pump, brass

Pre-chromed brass with union nut with 1/2" pipe thread. Equipped with non-return valve. Conical suction nozzle of 11-12 mm. Total length 140



Item: 078720

Scissors with plastic handles

Lab scissors with plastic handle. Made of stainless steel.

Length: 200 mm



Item: 151520

Floor pump with manometer

Good robust pump with pressure gauge. Suitable for rocket and valve tests.



Item: 067120

Mini Incubator, Labnet, 9.2 L, 3

Compact incubator with room for 48 Petri dishes. The temperature is controlled by placing a thermometer in the dedicated hole in the top. Thermometer not included.



Item: 067160

Universal oven, Memmert, UN

Heating cabinet made of stainless steel with electronic temperature control from room temperature +5 °C to 300 °C. Digital display showing set and actual



Item: 102770

Balance, pocket balance, 200

Convenient and compact pocket scales with hinged lid, ideal for precise weighing on the go. The scales are equipped with



Item: 102890

Balance, 1000 g / 0.1 g

Digital scale with incredible value for money! Weighing range 0-1,000 grams with 0.1 g accuracy throughout the range. With tare and counting



Item: 102900

Digital Balance, 300 g / 0.01 g,

Small analytical scales for the price-conscious customer. Perfect for precise weighing in smaller labs, primary schools, or other educational



Item: 102930

Kern Balance, 2000 g / 0.1 g, 4

Robust and accurate Kern precision scales – ideal for accurate weighing in the laboratory, teaching or other environments where precision is important. These scales



Item: 102950

Kern Balance, 200 g / 0.01 g, 4

Robust and accurate Kern precision scales – ideal for accurate weighing in the laboratory, teaching or other environments where precision is important. These scales



Item: 102960

Kern Balance, 100 g / 1 mg, E

Milligram scales that are ideal for use in schools. A simple scale with only 2 buttons, so they are easy to use for students and teachers alike.



Item: 102964

Kern Balance, 200 g / 0.01 g

Precision scales that are ideal for use in schools. A simple scale with only 2 buttons, so they are easy to use for students and teachers alike.



Item: 102966

Kern Balance, 3000 g / 0.1 g

Precision scales that are ideal for use in schools. A simple scale with only 2 buttons, so they are easy to use for students and teachers alike.



Item: 103050

Kern Balance, 1200 g / 0.01 g

Precision scale that is well suited for the slightly more advanced laboratory, where there is room for it to have its permanent place.



Item: 103052

Kern Balance, 250 g / 0.001 g

Precision scale that is well suited for the slightly more advanced laboratory where there is room for it to have a fixed place.



Item: 103060

Kern Analytical Balance, 250 g

Kern analytical balance type ALS 250-4A. Large transparent windshield with 3 doors to ensure easy access to weighing area and sample.



Item: 103290

USB Kit for Ohaus Scout PRO

Used with the discontinued Ohaus scale 103240, which can then be used as a sensor for the PasPort data collection system from Pasco.



Item: 152000

Pycnometer, calibrated

Glass pycnometers are used to accurately determine the density of liquids and allow your students to work with concepts like density and volume in practice. Also



Item: 200570

Rod with sleeve

Suitable for clamping timer NL111256. Hammer lacquered sleeve with stainless steel rod. Diameter: Ø 10 mm.



Item: 075510

Labgas, dioxygen LQ

1lt O₂ in a disposable cylinder containing - it contains 14 L of gas at normal pressure (20 g) and compressed to one liter. Used with control valve (item no. 076000)



Item: 075520

Labgas, nitrogen LQ

Nitrogen N₂ in disposable bottle containing approx. 14 L at normal pressure. Used with control valve (item no. 076000)



Item: 075530

Labgas, CO₂ LQ

Carbonated CO₂ in disposable bottle containing approx. 14 L at normal pressure. Used with control valve (item no. 076000)



Item: 075540

Labgas, hydrogen LQ

Brint H₂ in disposable bottle containing approx. 14 L at normal pressure. Used with control valve (item no. 076000)



Item: 075550

Labgas, helium LQ

Helium He is compressed in a disposable bottle containing approx. 14 L at normal pressure corresponding to 2.5 g Helium. Used with control valve (item no. 076000)



Item: 076000

Fine control valve

Regulation valve for disposable bottles 0755xx. Designed in aluminum with screw-on plastic spigot Ø6 mm.



Item: 152010

Pycnometer, uncalibrated

Glass pycnometers are used to accurately determine the density of liquids and allow your students to work with concepts like density and volume in practice. Also



Item: 153010

Hydrometer

For determining the density of liquids
Density range : 1,000 - 2,000 g/cm³
Solubility : 0.010 g/cm³
Total length : 300 mm

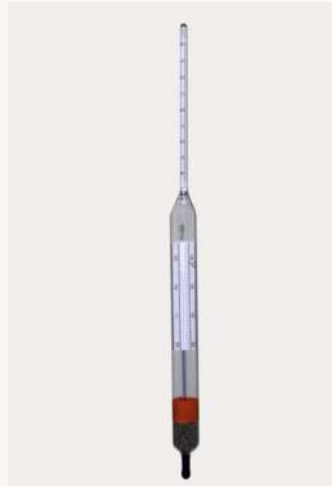

Item: 153030

Hydrometer, Seawater

To determine the salt content of seawater. With thermometer. Temperature table can be found under "Instructions for use" on this



Item: 067555

Microcentrifuge tubes 2 ml (fo

Sarstedt super quality polypropylene microcentrifuge tube with graduation and writing field. Due to the innovative SafeSeal lid design, the tube

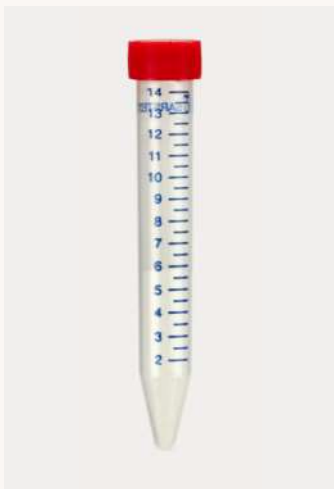

Item: 067575

Centrifuge Tube, PP, 15 mL, Ø1

Super quality from Sarstedt. Polypropylene tube with graduation and writing field. With red lid in HD-PE.



Item: 067590

Centrifuge Tube, PP, 50 mL, Ø

Falcon pipe from Sarstedt made of polypropylene. Conical bottom. 50 mL. With red lid in HD-PE. Packed in plastic bag containing 20



Item: 153090

Alcohol Meter

Floating scale for measuring alcohol percentage in liquids. Lower the floating scale into the wine and read the alcohol percentage.



Item: 153500

Vinometer

The vinometer is intended for measuring the alcohol content of wine that has been fermented and clarified, graduated in percent by volume for use at 15 C room



Item: 153510

Oechsle vægt

Oechsle scale (yeast meter) is a floating scale for determining the sugar content of wine or beer. Used to control the fermentation process.



Item: 173300

Cylinder flask, plastic

The cylinder glass is made of plastic and therefore not suitable for alcohol and solvents.

- Height 500 mm



Item: 144000

Caliper gauge, plastic

Plastic caliper. Equipped with depth gauge and vernier for reading 1/20 mm.

Total length: 150 mm Total length: 170 mm



Item: 144020

Caliper gauge, stainless steel

Quality caliper in stainless steel. Equipped with depth gauge and vernier for reading 1/20 mm. Measurement length: 150 mm



Item: 144030

Caliper gauge, digital

Simple and easy to read. With 0-position button. Resolution 0.01 mm. Jaw length 40 mm, largest opening 154 mm. Comes incl. battery in a sturdy



Item: 145050

Micrometer screw gauge

Micrometer screw with torque screw.

Measuring length: 0 - 25 mm. Accuracy: 0.01 mm.



Item: 146500

Measuring Jug, 0,5 L

Liter measure in natural colored impact resistant polyethylene. Graduated every 10 ml.

Volume: 0.5 liter



Item: 146510

Measuring Jug, 1 L

Liter measure in natural colored impact resistant polyethylene. Graduated every 10 ml.

Volume: 1 liter



Item: 803120-4

Ammonia water 2M, 1 L

About 3.5% NH₃ in water.
Purity: Pure



Item: 806900-1

Ascorbinsyre, ren

Synonym: Vitamin C Formula: C₆H₈O₆ Molecular weight: 176.13 Purity: Pure 100% CAS: 50-81-7



Item: 807350-8

Bariumchlorid, 0,5 M

11.3% BaCl₂ in water.
Molecular weight: 208.25



Item: 808000-2

Benedicts reagens

Used for glucose determination (glucose reagent). Contains, among other things, blue copper (II) sulfate which is converted to red copper (I) oxide when



Item: 576612

Tray, 75 mm, charcoal grey

The Granells system tray is specially designed for school and laboratory use. The tray is made of extra strong polypropylene and is fire retardant and anti-static. The



Item: 576550

Tray 150 mm, Midnight Blue

The Granells system tray is specially designed for school and laboratory use. The tray is made of extra strong polypropylene and is fire retardant and anti-static. The



Item: 027522

Porcelain Dish, 94 mm, Czech

The porcelain bowls from this Czech manufacturer are very solidly made. The bowls are glazed on the inside. On the outside, the bowls are glazed in a narrow band at the top,



Item: 027525

Porcelain dish, 100 mm

Porcelain bowl with round base and spout
Diameter: 100 mm
Obs: This is our affordable product. For better quality



Item: 028000

Crucible, 15 mL, high quality

Digel in porcelain of the Haldenwanger brand. Heat resistant to 1,000 °C. Volume: 15 mL Height: 28 mm Ø: 35 mm



Item: 028500

Lid to fit crucible, porcelain

Lid for porcelain crucible. Haldenwanger. Fits 028000.



Item: 028700

Crucible with lid, 15 mL

Digel in porcelain. Lid included. Volume: 15 ml Height: 30 mm Diameter: 35 mm Withstands heat up to approx.



Item: 028710

Crucible with lid, 25 mL

Digel in porcelain. Volume: 25 ml Height: 25 mm Diameter: 45 mm This is our affordable crucible. For better quality,



Item: 029600

Porcelain spotting plate with 1

Porcelain plate with 12 indentations. Useful for a variety of micro-chemistry experiments such as precipitation reactions, color reactions and reaction rates.



Item: 030000

Mortar with Pestle

Porcelain mortar with pestle. Outer Ø: 100 mm Inner Ø: 83 mm Depth: 45 mm This is our affordable mortar. For top quality we refer to our



Item: 030010

Mortar, Ø90/115 mm, high qual

Porcelain mortar with pouring spout from German Haldenwanger. top quality. Unglazed on the inside. Outer Ø: 115 mm Inner Ø: 90



Item: 030015

Pestle for 030010, 135 mm lon

Haldenwanger pestle in tempered porcelain for mortar (030010). The pestle is glazed on the handle but unglazed on the head. This maintains a good surface for



Item: 031016

Test tube stand, 18 mm, 1x6 ho

Autoclavable polypropylene test tube rack with draining sticks - for 6 tubes. Suitable for Ø18 mm test tubes.



Item: 031020

Test tube stand, PP, Ø18 mm, 1

Polypropylene autoclavable test tube rack
Number of holes: 1x10 Hole diameter: 18.0 mm



Item: 031060

Test Tube Stand, Ø20 mm, 3 x

Test tube rack in plastic-coated metal wire
Number of compartments: 3 x 4 Compartment diameter: 20 mm Height: 70 mm



Item: 031070

Test Tube Stand, Ø26 mm, 3 x

Test tube rack in plastic-coated metal wire
Number of compartments: 3 x 4 Compartment diameter: 26 mm Height: 70 mm



Item: 031080

Test Tube Stand, Ø31 mm, 3 x

Test tube rack in plastic-coated metal wire
Number of compartments: 3 x 4 Compartment diameter: 31 mm Height: 70 mm



Item: 031113

Test Tube Rack, Ø16 mm, 5 x 1

Autoclavable polypropylene test tube rack with 5x12 holes (60 in total) for Ø16 mm test tubes. The rack is equipped with small marks for row/column



Item: 031114

Test Tube Rack, Ø20 mm, 4 x 1

Autoclavable polypropylene test tube rack with 4x10 holes for Ø18 mm test tubes. The rack is equipped with small marks for row/column



Item: 031115

Test Tube Rack, Ø25 mm, 3 x

Autoclavable test tube rack in polypropylene with 3x8 holes for Ø25 mm test tubes. The rack is equipped with small marks for row/column



Item: 031116

Test Tube Rack, Ø30 mm, 3 x

Autoclavable test tube rack in polypropylene with 3x7 holes for Ø30 mm test tubes. The rack is equipped with small marks for row/column



Item: 031160

Combi rack for various test tu

Polypropylene stand with 4 sides with different hole sizes. Capacity: 4 x 50 mL (Ø29 mm) 12 x 15 mL (Ø16 mm) 32 x 1.5/2 mL tubes, Ø11 mm - or mini test tubes 10 or 12 x



Item: 031600

Drainer with tray

Practical rack with a total of 65 sticks and hangers for drying flasks, test tubes etc. Solidly made of plastic-coated metal wire.



Item: 032000

Pipette stand, wire, 20 holes, 1

Stand for pipettes, thermometers etc. Made of plastic-coated metal wire
Number of pipette slots: 20
Max pipette diameter: 13 mm



Item: 032500

Test tube clamp

Pull clamp for test tubes
Length: 170 mm Width: Ø max. 24 mm



Item: 032520

Test tube clamp, steel

Tray holder made of nickel-plated steel. spring clip.
Length: 13 cm



Item: 033002

Brush for Glass Tubing, 400 x

Brush with galvanized iron wire handle. Good for cleaning glass pipes.
Total length: 400 mm Brush Ø: 3 x 90 mm



Item: 033004

Test Tube Brush, Ø11 mm

Brush with soft cotton tip for cleaning test tubes Ø 10-12 mm
Total length: 160 mm Brush Ø: 11 x 50 mm



Item: 033010

Brush for Test Tubes, 16 - 20

Brush for cleaning test tubes
 ø 16-20 mm
 Total length: 300 mm Brush
 Ø: 20 x 80 mm



Item: 033020

Testtube Brush, Ø25 mm

Brush for cleaning jumbo test
 tubes
 Total length: 280 mm Brush
 Ø: 25 x 110 mm



Item: 033025

Beaker brush, L: 280, brush: 12

Functional brush for cleaning
 e.g. beakers.
 Total length: 280 mm brush Ø
 80 x 120 mm
 OBS: Handle color may vary



Item: 033050

Bottle cleaner, Ø90 mm

Bottle cleaner.
 Total length: 400 mm
 Brush Ø: 90 x 110 mm



Item: 033060

Flask cleaner with cotton tip, 5

Extra long flask cleaner for
 volumetric and conical flasks
 This flask cleaner is suitable for
 large 1 liter volumetric
 flasks, among others.



Item: 033080

Washing-up brush, plastic

Plastic brush with fine hog
 bristles.
 Total length: 250 mm



Item: 033100

Dish cloth, cotton

Waffle weave dishcloth in
 85% cotton.



Item: 033500

Ceramic gauze, 120 x 120 mm (

Ceramic wire mesh with
 folded edges and heat-
 resistant ceramic coating.
 Asbestos-free.
 Dimension: 120x120 mm



Item: 033600

Ceramic wire gauze 160 x160

Ceramic wire mesh with folded edges and heat-resistant ceramic coating. Asbestos-free.
Dimension: 160x160 mm



Item: 811508

Lighter gas, 300 mL

Lighter gas in refill canister.

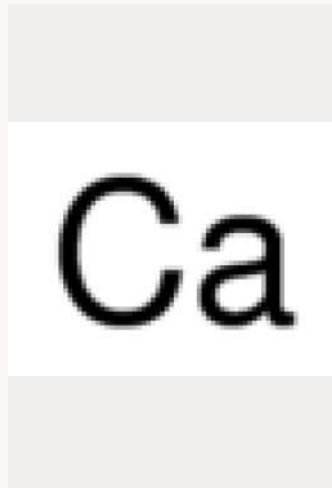

Item: 813200-05

Calcium, granulat, ren

Formula: Ca
Molecular weight: 40.08 g/mol
Purity: 98.5%
Hazard symbol: F
CAS: 7440-70-2



Item: 813800-4

Calcium carbonate, marble

For student use. Dimension: approx. 12x12 mm
Formula: CaCO₃
Molecular weight: 100.09
CAS: 471-34-1
Pure granules with a size of

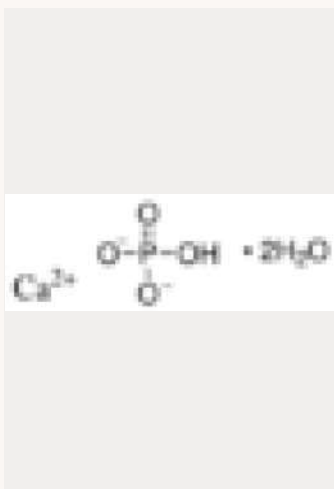

Item: 814400-2

Calciumdihydrogenphosphat

Formula: Ca(H₂PO₄)₂ - H₂O
Molecular weight: 252.07
Purity: Pure CAS: 10031-30-8



Item: 814500-2

Calciumhydroxid, 250 g, melfi

Synonym: Hydrated lime, milk lime, slaked lime
Formula: Ca(OH)₂
Molecular weight: 74.09
Purity: Pure CAS: 1305-62-0



Item: 814600-3

Calcium nitrate

Synonym: Calcium nitrate
Formula: Ca(NO₃)₂ - 4H₂O
Molecular weight: 236.15
Purity: Technically pure > 98.5%
CAS: 13477-34-4G



Item: 140500

Ruler, Wood, 50 cm

Wood yardstick with graduations in mm and cm. Made with metal fittings at the ends. Length : 50 cm
Cross section : 25 x 5 mm



Item: 140510

Ruler, Wood, 100 cm

Wood yardstick with graduations in mm and cm. Made with metal fittings at the ends. Length : 100 cm Cross section : 25 x 5 mm

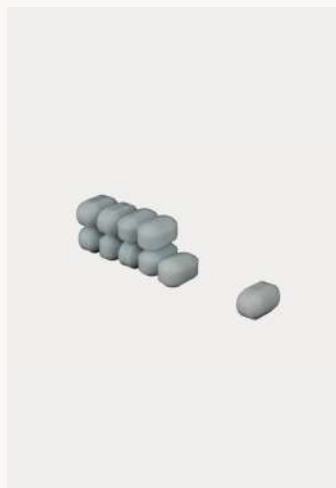

Item: 065504

Magnetic stir bar, 10 x Ø6 mm

PTFE-coated magnetic rod with a round, smooth surface. The small size (10 x 6 mm) makes it suitable for microscale chemistry etc. Very good chemical



Item: 065505

Magnetic stir bar, 12 x Ø4.5 mm

Stirring magnet with acid and heat resistant PTFE plastic cap. Cylindrical shape. Length: 12 mm. Diameter: 4.5 mm.



Item: 065508

Stir magnet, 20 x Ø6 mm

Stirring magnet with acid and heat resistant PTFE plastic cap. Cylindrical shape. Length: 20 mm. Diameter: 6 mm.



Item: 065510

Magnetic Stirring Bar, 25 x Ø6

Stirring magnet with acid and heat resistant PTFE plastic cap. Cylindrical shape. Length: 25 mm. Diameter: 6 mm.



Item: 065520

Magnetic Stirring Bar, 42 x Ø8

Stirring magnet with acid and heat resistant PTFE plastic cap. Cylindrical shape. Length: 40 mm. Diameter: 8 mm.



Item: 065610

Retrieval magnet PTFE, 350 mm

Teflon-coated rod with magnet for picking up pipe magnets from flasks and the like. Length: 350 mm Diameter: Ø 10 mm.



Item: 008430

Round flask, 1000 mL, Borosil

Round flask from Borosil. Made of chemical, thermal and mechanical resistant borosilicate glass Volume: 1000 ml Neck



Item: 068515

Suction/blowing bulb

Red soft PVC suction/blow ball - exhaust via the valve in the ball and suction via the hose. Used for filling and evacuation of pipettes and



Item: 066120

Heating mantle, 250 mL

Selecta heating cap in metal housing for round bottom flask 250 mL. With holder for tripod rod. Complete with 2-step regulation.



Item: 066200

Heating mantle, 250 mL, cera

Heating jacket with ceramic built-in heater with stepless power control that can be used with magnetic stirring. The outer jacket consists of



Item: 066510

Heating Mantle, 500 mL, Stepl

Electrothermal heating cap for 500 mL round flasks - with stepless power regulator. The heating cap has a polypropylene outer casing and is also equipped with a



Item: 576515

Gratnells trolley, double, grey

The system trolley solves the vast majority of transportation and storage tasks. The design of the trolley makes it easy to understand and use. Transportation between



Item: 053880

Waste Container, Approved, 10

Approved plastic waste bin. Suitable for collecting chemical waste
Volume: 10 L Dimensions (H x W x D): 30.5 x 19.5 x 22.0



Item: 034000

Crucible tripod, porcelain

Porcelain triangle in the shape of iron wire with ceramic tubes.
Dimension (tubes): 50 mm



Item: 041509

Filter Paper, Ø50 mm

Quality filter paper. Simple medium density filter.
Particle retention (liquid): Approx. 15 µm Weight: 65 g/m² Diameter: 50 mm



Item: 901230

Trolley

Rolling table with three shelves made of strong plastic and aluminum profiles. With handles at both ends. The trolley has solid rubber wheels for a stable and quiet



Item: 117930

Zinc wire, Ø3 mm x 15 m

Length: 15 m Diameter: 3 mm
Weight: Approx. 750 g



Item: 102965

Kern Balance, 1200 g / 0.1 g

Precision scales that are ideal for use in schools. A simple scale with only 2 buttons, so they are easy to use for students and teachers alike.



Item: 148552

Digital stopwatch, budget

Digital stopwatch with split time option. Uses battery (351604) included.



Item: 820600-1

Hexan-1,6-diamin

Synonyms: 1,6-Diaminohexane, 6-Hexanediamine, Hexamethylenediamine
Formula: C₆H₁₆N₂ Molecular weight: 116.2 g/mol CAS:



Item: 821300-8

Dimethylgly.opl. 1 %, dråbeflask

Nickel test/nickel reagent in ethanol. Used for qualitative detection of nickel in e.g. jewelry.



Item: 825218

Eddikesyre, 32 %, teknisk

Synonym: Ethanoic acid
Formula: CH₃COOH
Molecular weight: 60.05 CAS: 64-19-7



Item: 576626

Tray, 75 mm, solid lime

The Granells system tray is specially designed for school and laboratory use. The tray is made of extra strong polypropylene and is fire retardant and anti-static. The



Item: 576614

Tray, 75 mm, tropical orange

The Granells system tray is specially designed for school and laboratory use. The tray is made of extra strong polypropylene and is fire retardant and anti-static. The



Item: 576633

Tray, 150 mm, tropical orange

The Granells system tray is specially designed for school and laboratory use. The tray is made of extra strong polypropylene and is fire retardant and anti-static. The



Item: 011540

Graduated cylinder, low form, 1

Measuring glass - low shape. Made of glass with round base.

The division on the glass is fused on, making it chemical



Item: NL118155

Gauze, Stainless Steel, 155 x 15

Wire mesh made of stainless steel.



Item: 576616

Tray, 75 mm, pale blue

The Granells system tray is specially designed for school and laboratory use. The tray is made of extra strong polypropylene and is fire retardant and anti-static. The



Item: 014860

Burette, Teflon Stopcock, 50

Burette with angled Teflon tap. The Teflon tap ensures that the tap is both tight and easy to turn for significantly longer



Item: 014861

Burette, Teflon Stopcock, 0.1 -

The Schellbach stripe in the background makes it quick and easy to read the exact volume. The Teflon tap ensures that the tap is both tight and easy to turn for



Item: 014862

Burette, Teflon Stopcock, 0.1 -

The Schellbach stripe in the background makes it quick and easy to read the exact volume. The Teflon tap ensures that the tap is both tight and easy to turn for



Item: 014910

Burette, Automatic, 0.1 - 25 mL

Avoid the time-consuming and laborious work of filling and resetting the standard Schellbach burette. The Schilling burette consists



Item: 014915

Outlet Tip for Burette

This outlet tip fits e.g. the schilling burette 014910 or burette with spigot 014710.



Item: 015200

Pipette Filler, Peleus Bulb

Pipette ball "Peleusbold". Standard model. Made of heavy rubber without metal parts. The ball is equipped with



Item: 015290

Pipette Bulb for Micro Pipettes

Suction ball for micropipettes/capillary tubes.



Item: 015310

Pipette Pump, Blue, 2 mL

Gearwheel-operated pipette aspirator (Pi pump). Emptying can be done dropwise or quickly with outlet valve. Fast and safe operation.



Item: 015330

Pipette pump, green, 10 mL

Gearwheel operated pipette aspirator (Pi pump). Emptying can be done dropwise or quickly with outlet valve. Fast and safe operation.



Item: 015340

Pipette pump, red, 25 mL

Gearwheel operated pipette aspirator (Pi pump). Emptying can be done dropwise or quickly with outlet valve. Fast and safe operation.



Item: 015510

Crystallization Dish, DURAN, Ø

Crystallization bowl. Made of DURAN borosilicate glass. Volume: 150 mL Diameter: 80 mm Height: 40 mm



Item: 015520

Crystallization Dish, DURAN, Ø

Crystallization bowl. Made of DURAN borosilicate glass.
Volume: 900 mL Diameter: 140 mm Height: 75 mm



Item: 015610

Crystallizing Dish, Ø90 mm

Crystallization bowl in heat-resistant borosilicate glass and equipped with pouring spout.
Volume: 250 ml Diameter: 90



Item: 015620

Crystallizing Dish, Ø150 mm

Crystallization bowl in heat-resistant borosilicate glass and equipped with pouring spout.
Volume: 1000 ml Diameter:



Item: 015640

Crystallizing Dish, Ø180 mm, 2

Crystallization bowl in heat-resistant borosilicate glass and equipped with pouring spout.
Volume: 2000 ml Diameter:



Item: 015650

Crystallizing Dish, Ø230 mm

Crystallization bowl in heat-resistant borosilicate glass and equipped with pouring spout.
Volume: 3000 ml Diameter:



Item: 016530

Petri dish, glass, Ø100 x 15 mm

DURAN glass petri dish for the cultivation of microorganisms Autoclavable up to 121°C
Lid diameter: 100 mm Dish



Item: 016590

Petri dish, Plastic, Ø60 mm, st

Small sterile Petri dishes in transparent plastic. The Petri dish is high quality with ventilation ribs and heat resistant up to 80°C.



Item: 016610

Petri dish, plastic, Ø90 x 16 mm

Petri dishes in highly transparent polystyrene. Shatterproof and heat resistant up to 80°C. The bowl has 3 ventilation ribs that reduce condensation



Item: 016620

Petri dish, plastic, Ø150 x 20 m

Extra large sterile Petri dishes in transparent plastic. The Petri dishes are suitable as an aid to keep work with agar in small Petri dishes (Ø60 or Ø90 mm) free from



Item: 016710

Well Plate with Lid, 6 Wells

Microtiter plate/well plate with 6 flat bottom wells
Well volume: 3 mL



Item: 016720

Microtiter Plate with Lid, 24 W

Microtiter plate/well plate with 24 (6 x 4) flat bottom wells
Well volume: 1 mL



Item: 016730

Microtiter Plate, 96 wells, flat b

Microtiter plate/well plate with 96 wells. Molded in clear polystyrene with excellent optical quality, making it easier to use.



Item: 017010

Funnel, glass, Ø 40 mm/6 mm

Funnel made of borosilicate glass with beveled outlet and flame polished edges
Diameter: 40 mm Outlet Ø: 6 mm Angle: 60°



Item: 017020

Funnel, glass, Ø75 mm/9 mm

Heat-resistant glass funnel made of borosilicate glass with beveled outlet and flame-polished edges.
Can be used for collecting



Item: 017030

Funnel, glass, Ø100 mm/12 m

Funnel made of borosilicate glass with beveled outlet and flame polished edges
Diameter: 100 mm Outlet Ø: 8 mm Angle: 60°



Item: 017040

Funnel, glass, Ø150 mm/28 m

Glass funnel made of heat-resistant borosilicate 3.3.
Top diameter: 150 mm Outlet Ø: 25 mm Angle: 60°



Item: 017105

Funnel, plastic, Ø27 mm / 4 m

Plastic funnel with thin outlet for e.g. filling burettes.
Top diameter: 27 mm Outlet diameter: 4 mm



Item: 017120

Plastic funnel, Ø75 mm

Transparent plastic funnel with 60° angle
Top diameter: 75 mm Outlet diameter: 7 mm



Item: 017130

Funnel, plastic, Ø100 mm / 11

Transparent plastic funnel with 60° angle
Top diameter: 100 mm Outlet diameter: 11 mm



Item: 055786

Plastic bottle with lid, 250mL,

Round bottle with screw cap. Made of plastic (PE).
Content: 250 mL



Item: 055880

Jam jar with lid, 720 mL

Jelly jar with lid.
Content: 720 mL.



Item: 056120

Pipette flask, 50 mL

Pipette bottle in brown glass fitted with glass pipette with rubber ball in screw cap.
Volume: 50 ml



Item: 118530

Aluminium foil

Aluminum foil in rolls of 20 meters.



Item: 006900

Glass Beaker, Tall Form, 50 mL

Beaker - high form in the best quality. Made of borosilicate glass with division.
Content: 50 ml



Item: 837508

pH strip, 0-14, MN

Indicator in the form of 6 x 85 mm plastic rods. Colored pH-sensitive fields that are protected with a coating so that the rods do not "bleed". This means that samples are



Item: 837708

pH strip, 4.5-10, MN

Indicator in the form of 6 x 85 mm plastic rods. Colored pH-sensitive fields that are protected with a coating so that the bars do not "bleed". This means that samples are



Item: 838100

pH-paper 1-14, 5 metres Holde

Roll with pH paper with scale 0-14. The color scale is printed on the box. Length: 5 meters



Item: 017140

Funnel, plastic, Ø150 mm / 16

Transparent plastic funnel with 60° angle
Top diameter: 150 mm Outlet diameter: 16 mm



Item: 017150

Funnel, plastic, with fine tip, Ø

Transparent plastic funnel with fine tip. 60° angle.
Top diameter: 40 mm Outlet diameter: 5 mm



Item: 017510

Büchner funnel, Ø90 mm, por

Büchner funnel made of porcelain.
The Büchner funnel is a useful device for suction filtration of precipitated



Item: 017550

Büchner funnel, Ø50 mm, por

Büchner funnel made of porcelain.
The Büchner funnel is a useful device for suction filtration of precipitated



Item: 017590

Büchner funnel, Ø90 mm, plas

Plastic filter funnel. For filters with Ø: 90 mm
The funnel is a useful device for e.g. suction filtration of precipitated products



Item: 017600

Büchner Rings for Büchner Fu

Set of conical rubber rings for mounting the funnel in the suction flask.

Ring: inner upper/lower outer upper/lower:



Item: 017700

Conical rubber ring, Ø42 mm

Conical rubber ring (Ø 42/33 mm) for mounting the Büchner funnel in the suction flask.

Outer diameter: Max/min



Item: 017800

Glass Filter Crucible, G4, Ø25

Glass filter crucible that can be used for e.g. suction filtration.

Volume: 30 ml Filter diameter: Ø 30 mm Porosity:



Item: 017820

Glass Filter Crucible, G4, Ø33

Glass filter crucible that can be used for e.g. suction filtration.

Volume: 50 ml Filter diameter: Ø 40 mm Porosity:



Item: 018020

Separating funnel, 250 mL, gla

Borosilicate glass funnel with NS plug and glass tap

Volume: 250 ml NS plug: 24/29



Item: 018510

Funnel, powder, plastic, Ø80/2

Semi-transparent powder funnels made of polypropylene, with a wide outlet so the funnel can be used for powder or granules.



Item: 018520

Funnel, powder, plastic, Ø100/

Semi-transparent powder funnels made of polypropylene, with a wide outlet so the funnel can be used for powder or granules.



Item: 019510

Glass tube, Straight with tip

Processed glass tube. Straight tube with tip.

- Outer diameter: 7 mm
- Inner diameter: 5.75

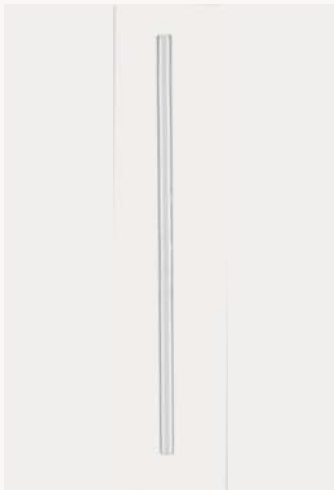

Item: 019520

Glass Tube, Straight

Processed, straight glass tube of 18 cm.

- Outer diameter: 7 mm.

Wall thickness: 1.25

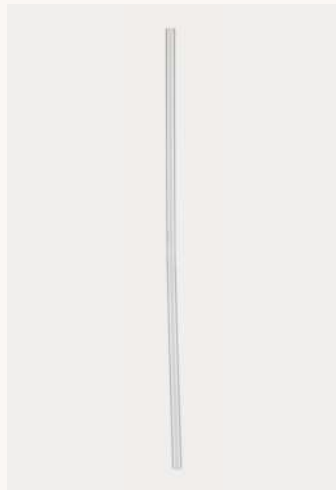

Item: 019530

Glass Tube, 30 cm, Ø7 mm

Processed, straight glass tube of 30 cm.

- Outer diameter: 7 mm.

Wall thickness: 1.25

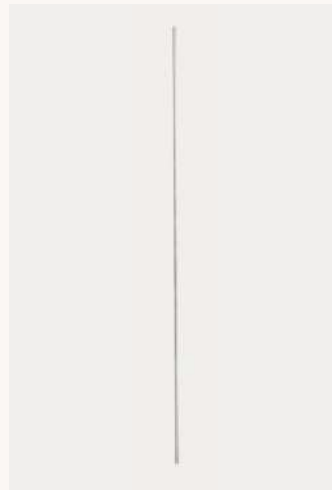

Item: 019535

Glass Tube, 100 cm

Processed, straight glass tube of 100 cm.

- Outer diameter: 7 mm.

Wall thickness: 1.25



Item: 019540

Glass Tube, 90° angle

Processed glass tube 7x7 cm. Angle tube 90°. Outer diameter: 7 mm. Wall thickness: 1.25 mm.

Fits hose Ø6/9 mm (e.g.)



Item: 019545

Glass Tube, Angled 90°, with tip

Processed glass tube 7x7 cm. Angle tube 90° with tip. Outer diameter: 7 mm. Wall thickness: 1.25 mm.

Fits hose Ø6/9 mm (e.g.)



Item: 019550

Glass Tube, Angled 90°, 7 x 20

Processed glass tube 7x20 cm. Angle tube 90°. Outer diameter: 7 mm. Wall thickness: 1.25 mm.

Fits hose Ø6/9 mm (e.g.)



Item: 019560

Glass Tube, Angled 30°, 20 x 2

Processed glass tube 20x20 cm. Angle tube 30°. Outer diameter: 7 mm. Wall thickness: 1.25 mm.

Fits hose Ø6/9 mm (e.g.)



Item: 019620

Glass Tube, T-branch, Ø7 mm

Processed, glass manifold in T shape. Outer diameter: 7 mm. Wall thickness: 1.25 mm. Length: 9x6 cm.

Fits hose Ø6/9 mm (e.g.)



Item: 019710

Glass tube, heat resistant, Ø6

Heat-resistant glass tube (combustion tube). Ø: 6 mm, Length: 100 mm.



Item: 020015

Glass Tube, 50 cm, Ø5.0 x 3 mm

Unprocessed straight glass tube.

- Outer diameter: 5 mm
- Inner diameter: 3



Item: 020020

Glass Tube, 50 cm, Ø6 x 4 mm

Unprocessed straight glass tube.

- Outer diameter: 6 mm
- Inner diameter: 4



Item: 020030

Glass Tube, 50 cm, Ø7 x 4.4 mm

Unprocessed straight glass tube.

- Outer diameter: 7 mm
- Inner diameter: 4.4



Item: 020040

Glass Tube, 50 cm, Ø8 x 6 mm

Unprocessed glass tube. Outer/Inner Ø: 8/6 mm Length: 50 cm



Item: 020060

Glass tube, 50 cm, Ø11 x 8 mm,

Glass tube. Outer/Inner Ø: 11/8 mm Length: 50 cm Unfinished straight glass tube. Outer diameter: 11 mm



Item: 020090

Glass Tube, Ø7 mm x 50 mm

Glass tube. Outer diameter: 7 mm Inner diameter: 4.5 mm Length: 50 mm Fits holes in 7 mm rubber



Item: 020110

Acrylic tube, 1 m, Ø38/32 mm

This acrylic tube can also be used as a kayak tube if you want a longer tube than the regular kayak tubes. However, it is not pointed at the end, so it needs to be



Item: 020300

Capillary tube, Ø1.65/1.2 mm x

Hair tube in borosilicate glass. For absorbing small amounts of liquids. Can be heated and pulled into swabs or sealed with wax and spun.



Item: 020400

Melting Point Tube, Ø1.4 mm, 1

Melting point tube made of borosilicate glass. Glass tube that is fused at one end. Outer/inner Ø: 1.4 / 1.0 mm Length: 100 mm



Item: 021000

Glass Beads, Ø3 - 4 mm

Glass balls that can be used as cooking stones or column fillings, for example. The advantage of using glass is the durability of the material. Glass is resistant to most



Item: 021510

Syringe, 0,1 mL - 2 mL

Glass syringe made of borosilicate glass with precision ground glass plunger and barrel. Centered conical Luer-lock metal cone of 4-4.5



Item: 021530

Glass Syringe, 20 mL - 1 mL

Glass syringe made of borosilicate glass with a glass tip that has a precision ground glass plunger and barrel



Item: 021550

Glass Syringe, 100 mL - 2 mL

Glass syringes made of borosilicate glass with precision ground glass plunger and barrel. Centered conical Luer-lock metal cone of 4-4.5



Item: 022005

Plastic syringe, 1 mL/0.01 mL

Disposable plastic syringe. Volume: 1 mL Graduation: 0.01 mL Stud diameter: 4/4.5 mm



Item: 022018

Plastic syringe, 5 mL/0.2 mL

Disposable plastic syringe. Volume: 5 mL Graduation: 0.2 mL Stud Ø: 4/4.5 mm



Item: 022400

Zentrop Dropping Dispenser

Zentrop drop dispenser. The Zentrop dropper nozzle is suitable for dosing e.g. iodine solution or strong dyes. Depending on the liquid, it will



Item: 041512

Filter Paper, Frisenette, Ø70 mm

Quality filter paper. Simple medium-tight filter
Fits funnel 017570
Particle retention (liquid): approx. 15 µm Weight: 65



Item: 041515

Filter Paper, Frisenette, Ø90 mm

Quality filter paper. Simple medium-tight filter
Particle retention (liquid): approx. 15 µm Weight: 65 g/m2 Diameter: Ø 90 mm



Item: 041520

Filter Paper, 100 mm, 1000 pcs

Quality filter paper. Simple medium-tight filter
Particle retention (liquid): approx. 15 µm Weight: 65 g/m2 Diameter: Ø 100 mm



Item: 041530

Filter Paper, 125 mm, 1000 pcs

Quality filter paper. Simple medium-tight filter
Particle retention (liquid): approx. 15 µm Weight: 65 g/m2 Diameter: Ø 125 mm



Item: 041540

Filter Paper, 150 mm, 1000 pcs

Quality filter paper. Simple medium-tight filter
Particle retention (liquid): approx. 15 µm Weight: 65 g/m2 Diameter: Ø 150 mm



Item: 003820

Retort ring with clamp, Ø 100,

Cooking ring 100 mm with fixed stand sleeve. Can be used for e.g. round-bottomed flasks or to hold a separating funnel.



Item: 011720

Graduated cylinder, PP, 10 mL,

Measuring cylinder made of soft polypropylene.
Volume: 10 mL
Polypropylene measuring cylinders are very durable



Item: 011721

Graduated cylinder, PP, 25 mL,

Measuring cylinder made of soft polypropylene.
Volume: 25 mL
Polypropylene measuring cylinders are very durable



Item: 011722

Graduated cylinder, PP, 50 mL,

Measuring cylinder made of soft polypropylene.
Volume: 50 mL
Polypropylene measuring cylinders are very durable



Item: 011723

Graduated cylinder, PP, 100 m

Measuring cylinder made of soft polypropylene.
Volume: 100 mL
Polypropylene measuring cylinders are very durable



Item: 011724

Graduated cylinder, PP, 250 m

Measuring cylinder made of soft polypropylene.
Volume: 250 mL
Polypropylene measuring cylinders are very durable



Item: 011725

Graduated cylinder, PP, 500 m

Measuring cylinder made of soft polypropylene.
Volume: 500 mL
Polypropylene measuring cylinders are very durable



Item: 011726

Graduated cylinder, PP, 1000

Measuring cylinder made of soft polypropylene.
Volume: 1000 mL
Polypropylene measuring cylinders are very durable



Item: 085030

Safety goggles, Child size

Tight-fitting lightweight glasses for children and young people. Very similar to our [085010](#), but about 1 cm narrower.



Item: 002325

Boss head, swivel, budget line

Pivotable tripod sleeve made of powder-coated die-cast zinc.
The tripod sleeve has an adjustment joint with a



Item: 054720

Lab Bottle, 250 mL, GL45 Cap,

Simax lab bottle in borosilicate 3.3 with attached pouring ring and GL45 bluecap.

This is our affordable glass,



Item: 054730

Lab Bottle, 500 mL, GL45 Cap,

Simax lab bottle in borosilicate 3.3 with attached pouring ring and GL45 bluecap.

This is our affordable glass,



Item: 054740

Lab Bottle, 1000 mL, GL45 Cap

Simax lab bottle in borosilicate 3.3 with attached pouring ring and GL45 bluecap.

This is our affordable glass,



Item: 006700

Glass Beaker, Tall Form, 50 mL

Beaker made of Borosilicate 3.3.

This is our affordable alternative. The glasses are tried and tested and found to



Item: 006710

Glass Beaker, Tall Form, 100 m

Cups made of Borosilicate 3.3.

This is our affordable alternative. The glasses are tried and tested and found to



Item: 006760

Glass Beaker, Tall Form, 1000

Beaker made of Borosilicate 3.3.

This is our affordable alternative. The glasses are tried and tested and found to



Item: 024161

Round-Bottom Flask, 500 mL,

Round-Bottom flask with grinder (NS 19/26). Made of heat-resistant borosilicate glass. Volume: 500 ml
Fit for:



Item: 006910

Glass Beaker, Tall Form, 100 m

Beaker - high form in the best quality. Made of borosilicate glass with division.

Content: 100 ml Diameter: 47 mm Height: 80 mm



Item: 006920

Glass Beaker, Tall Form, 150 m

Beaker - high form in the best quality. Made of borosilicate glass with division.
Content: 150 ml Diameter: 53 mm Height: 96 mm



Item: 006930

Glass Beaker, Tall Form, 250 m

Beaker - high form in the best quality. Made of borosilicate glass with division.
Content: 250 ml Diameter: 61 mm Height: 117 mm



Item: 006940

Glass Beaker, Tall Form 400 m

Beaker - high form in the best quality. Made of borosilicate glass with division.
Content: 400 ml Diameter: 70 mm Height: 130 mm



Item: 022020

Plastic syringe, 10 mL/0.5 mL

Disposable plastic syringe. Volume: 10 mL Graduation: 0.5 mL Stud diameter: 4/4.5 mm



Item: 022030

Plastic syringe, 20 mL/1 mL

Disposable plastic syringe. Volume: 20 mL Graduation: 1 mL Stud Ø: 4/4.5 mm



Item: 022040

Plastic syringe, 60 mL

Disposable plastic syringe. Volume: 60 mL Graduation: 1 mL Stud Ø: 4/4.5 mm



Item: 022050

Plastic syringe, 100 mL/2 mL

Disposable plastic syringe. Volume: 100 mL Division: 2 mL Nozzle diameter: 7/10 mm A nozzle adapter for a 4 mm



Item: 022096

Needle for Plastic Syringe, 4 -

Sterile disposable needles with double-ground slim blade. Fits standard luer and luer-lock syringes. Length: 30 mm Thickness:



Item: 022310

Test Tube with Screw Top, Ø16

Test tubes with round base and solid wall thickness for reusability. With GL 18 thread and screw cap. Diameter: 16 mm. Length: 160 mm

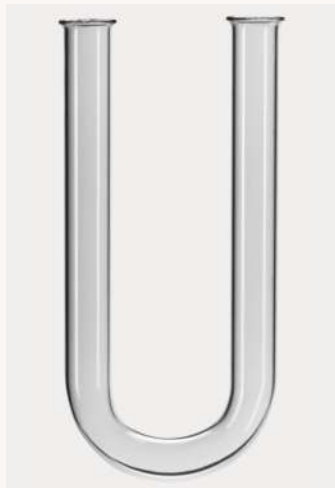

Item: 023020

U-tube

U-tube in glass. Ø: 18 mm. Height: 180 mm.



Item: 023530

Chromatography tank with lid

Chromatography vessel with lid. Glass vessel with polished rim and glass plate lid. Height: 15 cm Length: 10.5



Item: 001740

Stand clamp, universal, budget

Tripod clamp with 4-finger fork grip made of die-cast zinc. The clamp has a cork coating for better grip on the item to be held. Can clamp objects with a diameter of



Item: 001750

Stand clamp with bosshead, t

Tripod clamp with fork grip and adjustable tripod sleeve. Made of aluminum. The clamp is equipped with PVC for better grip on the object to be



Item: 001760

Stand clamp with bosshead, r

Tripod clamp with round jaws and adjustable tripod sleeve. Made of die-cast zinc. The clamp has a cork coating for better grip on the object to be



Item: 002305

Boss head, budget line

Standard stand sleeve made of powder-coated die-cast zinc. Holds items up to Ø 16mm.



Item: 024035

Distillation kit, semi-micro

Glass construction kit for building semi-microscale distillation apparatus. The individual parts are with normal grinding NS 14/23.



Item: 024055

Distillation kit, small

This distillation kit is a complete glass kit designed for organic chemistry. It is suitable for small-scale experiments and is equipped with NS 14/23 grinding, which



Item: 024065

Distillation kit, large

Glass construction kit for organic chemistry. The individual parts are with NS 19/26 and NS 24/29 grinding. The kit consists of:



Item: 024095

Round-Bottom Flask, 50 mL, N

Round-Bottom flask with grinder (NS 19/26). Made of heat-resistant borosilicate glass. Volume: 50 ml
Fitting stoppers:



Item: 024100

Round-Bottom Flask, 100 mL, N

Round-Bottom flask with grinder (NS 19/26). Made of heat-resistant borosilicate glass. Volume: 100 ml
Fitting stoppers:



Item: 024120

Round-Bottom Flask, 100 mL, N

Round-Bottom flask with grinder (NS 24/29). Made of heat-resistant borosilicate glass. Volume: 100 ml
Fitting stoppers:



Item: 024130

Round-Bottom Flask, 250 mL, N

Round-Bottom flask with grinder (NS 19/26). Made of heat-resistant borosilicate glass. Volume: 250 ml
Fit for:



Item: 024140

Round-Bottom Flask, 250 mL, N

Round-Bottom flask with grinder (NS 24/29). Made of heat-resistant borosilicate glass. Volume: 250 ml
Fitting stoppers:



Item: 024150

Round-Bottom Flask, 250 mL, N

Round-Bottom flask with grinder (NS 29/32). Made of heat-resistant borosilicate glass. Volume: 250 ml
Fitting plugs:



Item: 024160

Round-Bottom Flask, 500 mL,

Round-Bottom flask with grinder (NS 24/29). Made of heat-resistant borosilicate glass. Volume: 500 ml
Fit for:



Item: 024170

Erlenmeyer Flask, NS 24/29, 2

Conical flask in heat-resistant borosilicate glass with grind (NS 24/29).
Volume: 250 ml
Fit for:



Item: 024180

Flask, pear-shaped, 5 mL, NS1

5 mL pear-shaped flask for microchemistry with abrasive NS 14/23.
Fit for:
024359 (NS 14/23) Glass



Item: 024220

Condenser, Liebig, 35 cm, NS1

Liebig swallows. Made of borosilicate glass.
Cone and jacket: NS19/26
Total length: 35 cm Cooling jacket length: 20 cm Glass



Item: 024250

Receiver, NS19/26, 65 mm

Publishing tube, bent 105° (NS19/26). Made of borosilicate glass. Stem length: 65 mm.
Used for collecting distillate



Item: 024270

Still Head, 2 x NS19/26

Distillation unit with thermometer cap. Made of borosilicate glass. Used as a 3-branch connection between flask (or column) and coolers.



Item: 024351

Ground glass joint clip, steel f

Ground glass joint clip - NS14/23. For clamping normal grinding. Made of stainless spring steel.



Item: 024352

Ground glass joint clip, steel f

Ground glass joint clip - NS19/26. For clamping normal grinding. Made of stainless spring steel.



Item: 024450

Extraction Apparatus, set

This complete Soxhlet apparatus allows you to introduce students to classic extraction techniques in the lab. The device is typically used to isolate specific



Item: 025210

Fermentation lock, plastic, ste

Bubble tube, in plastic for use in fermentation processes. The bubble tube is a simple but very useful piece of equipment. The tube acts as a one-way valve that lets the



Item: 025250

Screw top, GL45, for fermentat

Screw cap GL45 with 33 mm hole incl. silicone insert with \varnothing 9 mm hole, suitable for yeast tubes with 10 mm stem. The cap fits the stand-up



Item: 026510

Burning tube

Combustion tube. DURAN glass. Highly fusible glass tube. Diameter: 22/18 mm Length: 260 mm (straight)



Item: 027512

Porcelain Dish, 77 mm, Czech

The porcelain bowls from this Czech manufacturer are very solidly made. The bowls are glazed on the inside. On the outside, the bowls are glazed in a narrow band at the top,



Item: 027515

Porcelain Dish, 80 mm

Porcelain bowl with round base and spout. Diameter: 80 mm Obs: This is our affordable product. For better quality



Item: 011520

Graduated cylinder, low form,

Measuring glass - low shape. Made of glass with round base. The division on the glass is fused on, making it chemical



Item: 011530

Graduated cylinder, low form,

Measuring glass - low shape. Made of glass with round base. The division on the glass is fused on, making it chemical



Item: 011550

Graduated cylinder, low form,

Measuring glass - low shape. Made of glass with round base.

The division on the glass is fused on, making it chemical



Item: 576636

Tray, 150 mm, grass green

The Granells system tray is specially designed for school and laboratory use. The tray is made of extra strong polypropylene and is fire retardant and anti-static. The



Item: 576668

Tray, 225 mm, royal blue

The Granells system tray is specially designed for school and laboratory use. The tray is made of extra strong polypropylene and is fire retardant and anti-static. The



Item: 576669

Tray, 225 mm, grass green

The Granells system tray is specially designed for school and laboratory use. The tray is made of extra strong polypropylene and is fire retardant and anti-static. The



Item: 042040

Chromatography paper, MN 21

Chromatography paper for paper chromatography MN 214.

The paper is porous, so runners can penetrate far up



Item: 042610

Stopper, Ø13/16 mm, no hole

Tapered rubber plugs without holes made of red natural rubber. Can be used at temperatures from -30 to 60 °C



Item: 576685

Tray, 150 mm, jet black

The Granells system tray is specially designed for school and laboratory use. The tray is made of extra strong polypropylene and is fire retardant and anti-static. The

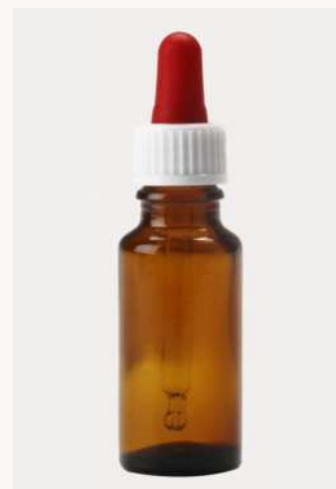

Item: 056108

Pipette Flask, 20 mL

Brown glass pipette bottle fitted with glass pipette with rubber ball in screw cap. Volume: 20 ml



Item: 838908

pH paper in Tri-box

Plastic cassette with indicator paper in rolls. A quality product from Macherey-Nagel. pH range: 1-11 graduation in pH: 1.0 The paper is impregnated with pH



Item: 839108

Litmus paper, blue, base, book

Lacmus paper - blue. Changes color from blue to red if the pH of the solution goes from alkaline to acidic. 100 strips per booklet.



Item: 839208

Litmus paper, red, acid, booklet

Lacmus paper - red. Changes color from red to blue if the pH of the solution goes from acidic to basic. 100 strips per booklet.



Item: 840550-8

Methyl red solution in dropper

pH indicator - Methyl red solution. Cover range: 4.4-6.2 Cover color: red <> yellow



Item: 852200-4

Saturated lime water, 1 litre

About 0.02 M Ca(OH)₂ - aqueous solution. Molecular weight: 74.09 CAS: 1305-62-0



Item: 852200-5

Saturated lime water, 2,5 litre

About 0.02 M Ca(OH)₂ - aqueous solution. Molecular weight: 74.09 CAS: 1305-62-0



Item: 853500-3

Copper(II) chloride dihydrate

- Formula: CuCl₂ · 2H₂O Molecular
 - Weight: 170.48
 - Purity: Technical
 - CAS: 10125-13-0
- Synonym: Cupric Chloride,



Item: 854500-4

Copper(II) sulphate, technical,

Synonym: Copper Sulfate/Bluerite/Copper Vitriol
 Formula: CuSO₄ · 5H₂O CAS: 7758-99-8 Molecular Weight: 249.68 Purity: Technically



Item: 859500-1

Lithiumsulfat, ren

Formula: $\text{Li}_2\text{SO}_4 - \text{ca.}2\text{H}_2\text{O}$
 Molecular weight: 127.96
 Purity: Pure CAS: 10102-25-7



Item: NL119362

Tray, 75 mm, midnight blue

The Granells system tray is specially designed for school and laboratory use. The tray is made of extra strong polypropylene and is fire retardant and anti-static. The



Item: NL119380

Tray, 300 mm, sunshine yellow

The Granells system tray is specially designed for school and laboratory use. The tray is made of extra strong polypropylene and is fire retardant and anti-static. The



Item: NL119403

Tray, 225 mm, translucent

The Granells system tray is specially designed for school and laboratory use. The tray is made of extra strong polypropylene and is fire retardant and anti-static. The



Item: NL119410

Tray, 150 mm, charcoal grey

The Granells system tray is specially designed for school and laboratory use. The tray is made of extra strong polypropylene and is fire retardant and anti-static. The



Item: NL117415

Measuring cylinder, SAN, cryst

Measuring cylinder with clear graduation, round 60 mm base and pouring spout.

- Made of hard crystal clear (SAN) plastic.



Item: NL119431

Tray, 150 mm, lime jolly

The Granells system tray is specially designed for school and laboratory use. The tray is made of extra strong polypropylene and is fire retardant and anti-static. The



Item: 002220

Burette Holder for 1, Al, Budge

Burette holder made of painted aluminum. With black PVC plastic that ensures a good grip on the burette. Holds up to 100 ml burettes.



Item: 003815

Retort ring with clamp, Ø 80 B

Cooking ring 80 mm with fixed stand sleeve. Can be used for e.g. round-bottomed flasks or to hold a separating funnel.



Item: 007320

Glass Beaker, Low Form, 100

This is our affordable alternative of low beakers. The glasses are made of borosilicate 3.3 and are tested and proven, so you get an excellent glass that is a



Item: 007330

Glass Beaker, Low Form, 250

This is our affordable alternative of low beakers. The glasses are made of borosilicate 3.3 and are tested and proven, so you get an excellent glass that is a



Item: 007335

Glass Beaker, Low Form, 400

This is our affordable alternative of low beakers. The glasses are made of borosilicate 3.3 and are tested and proven, so you get an excellent glass that is a



Item: 007350

Glass Beaker, Low Form, 1000

This is our affordable alternative of low beakers. The glasses are made of borosilicate 3.3 and are tested and proven, so you get an excellent glass that is a



Item: 007360

Glass Beaker, Low Form, 2000

This is our affordable alternative of low beakers. The glasses are made of borosilicate 3.3 and are tested and proven, so you get an excellent glass that is a



Item: 007535

Glas Beakers, Low Form, 400

DURAN beaker, low shape. Made of borosilicate glass with division. Volume: 400 ml Glass from DURAN is top



Item: 007800

Erlenmeyer flask, 100 mL, Econ

This is our affordable alternative of conical flasks. The flasks are made of borosilicate 3.3 and are tested and proven, so you get an excellent glass that is a



Item: 007810

Erlenmeyer flask, 250 mL, Eco

This is our affordable alternative of conical flasks. The flasks are made of borosilicate 3.3 and are tested and proven, so you get an excellent glass that is a



Item: 007820

Erlenmeyer flask, 500 mL, Eco

This is our affordable alternative of conical flasks. The flasks are made of borosilicate 3.3 and are tested and proven, so you get an excellent glass that is a



Item: 007830

Erlenmeyer flask, 1000 mL, Eco

This is our affordable alternative of conical flasks. The flasks are made of borosilicate 3.3 and are tested and proven, so you get an excellent glass that is a



Item: 007840

Erlenmeyer flask, 2000 mL, Eco

This is our affordable alternative of conical flasks. The flasks are made of borosilicate 3.3 and are tested and proven, so you get an excellent glass that is a



Item: 011220

Graduated cylinder, tall, 10 mL

High form measuring cup made of heat-resistant borosilicate glass with spout and round base.
Volume: 10 ml



Item: 011230

Graduated cylinder, tall, 25 mL

High-form measuring cup made of heat-resistant borosilicate glass with spout and round base.
Volume: 25 ml



Item: 011250

Graduated cylinder, tall, 100 mL

High-form measuring glass made of heat-resistant borosilicate glass with spout and round base.
Volume: 100 ml



Item: 011280

Graduated cylinder, tall, 1000 mL

High form measuring cup made of heat-resistant borosilicate glass with spout and round base.
• Volume: 1000 mL



Item: 016630

Petri dish with three compart

Three-piece Petri dish. Useful for e.g. antibiotic trials with bacteria where the effect is easily comparable or e.g. for cultivation trials with yeast



Item: 064045

Magnetic Stirrer, 300 - 2000 r

Stackable magnetic stirrer with precise control of the stirring speed. Designed to optimize space and efficiency in the laboratory. With a diameter of just 120mm and a



Item: 102808

Balance, Digital, 15 kg / 1 g

Digital scale in a slim design with a spacious weighing plate and an easy-to-read LCD display that makes precision weighing a breeze. This scale is ideal for a



Item: 103025

Kern scale, 600 g / 0,001 g, P

New lab scale from Kern & Sohn. Type PNJ-600-3M. This scale is very user-friendly and, as something new, equipped



Item: 066735

Flask weight with PVC coating

Heavy, plastic-coated ring for holding conical flasks in (shaking) water baths.

- Outer diameter approx. 9.5 cm.



Item: 066800

Hob, dual, 230 V

Single or dual hotplates – versatile and practical hotplates designed for a wide range of applications. The hotplates have a white enamel cabinet and a raised



Item: 066810

Hob, single, 230 V

Single or dual hotplates – versatile and practical hotplates designed for a wide range of applications. The hotplates have a white enamel cabinet and a raised



Item: 067010

Dry Heat Sterilizers Nuve, 44 L

Model FN 400. User-friendly, high-quality heating cabinet with high temperature precision and natural convection.



Item: 067020

Incubator, Nuve, 44 L, 30 - 80

Model EN 400. User-friendly, high-quality incubator with high temperature precision and natural convection. Large control panel with digital display for time and



Item: 067055

Incubator, Memmert, IN30, 30

Incubator from Memmert made of stainless steel with electronic temperature control from room temperature +5°C up to +80°C. With digital display of set and actual



Item: 848700-2

Potassium chloride, pure 250

Formula: KCl Molecular weight: 74.56 Purity: Pure CAS: 7447-40-7

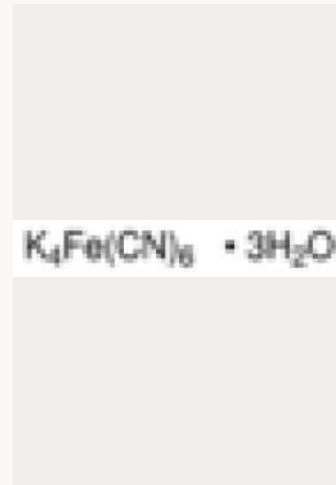

Item: 849800-3

Potassium ferrocyanide, yellow

Synonym: Yellow blood lead salt Formula: $K_4Fe(CN)_6 \cdot 3H_2O$ Molecular Weight: 329.26 Purity: Pure CAS: 14459-95-1



Item: 851100-3

Potassium iodide, pure

Molecular weight: 166.01 Purity: Pure CAS: 7681-11-0



Item: 851400-2

Potassium nitrate, 250 g

Synonym: Norgessalpeter Formula: KNO_3 Molecular weight: 101.11 Purity: Technically pure CAS: 7757-79-1



Item: 065506

Magnetic stir bar, 15 x Ø6 mm

Stirring magnet with acid and heat resistant PTFE plastic cap. Cylindrical shape. Length: 15 mm. Diameter: 6 mm.



Item: 001700

Stand clamp with overlapping

Tripod clamp with fork grip made of aluminum. The clamp is equipped with PVC for better grip on the item to be held.



Item: 001710

Stand clamp with rounded jaw

Tripod clamp with round jaws made of die-cast zinc. The clamp has a cork coating for better grip on the object to be held.



Item: NL118031

Platinum electrodes, 2 pieces

Set of platinum electrodes fused into glass tubes with 4 mm connection plugs. Suitable for e.g. Hofmann device and bang-gas device.



Item: NL119479

Gratnells foam insert, 30x,15 x

Foam insert with cut-outs to fit e.g. stopwatches.



Item: 012560

Test Tube, Ø38 x 200 mm, wit

Jumbo test tubes with collar. The test tubes are characterized by high glass quality and attractive design. All Borosil test tubes are made of heat-resistant 3.3



Item: 545550

Spectrophotometer UV, LLG u

UV spectrophotometer with wavelength range from 190 nm to 1100 nm that can be used alone (LCD panel) or connected to a computer via USB



Item: 102970

Kern Balance, 5000 g / 1 g, FO

New stainless steel scales from Kern that are easy to clean thanks to the smooth surfaces. High mobility: Due to the compact, flat construction, it is suitable for



Item: 038524

Silicon tubing, Ø2/4 mm

Plastic hose in silicone. Length: 5m. Inner/outer diameter: 2/4 mm



Item: 576772

Insert for 20 safety goggles

Foam insert for Gratnell trays with 20 cut-outs (50 x 40 mm) suitable for e.g. safety glasses.



Item: 576613

Tray, 75 mm, plum purple

The Granells system tray is specially designed for school and laboratory use. The tray is made of extra strong polypropylene and is fire retardant and anti-static. The



Item: 005112

Gas Burner, Economy

Gas burner nozzle with adjustable gas flow – designed for easy mounting on gas canisters and for precise control of gas flow. This nozzle is screwed onto



Item: 102990

Kern Balance, 4200 g / 0.01 g,

Precision scale ideal for use in school
Weighing range: 4200 g.
Accuracy: 0.01 g



Item: 576684

Foam insert for smartphones I

Easy and safe storage for larger smartphones during class time. Practical foam insert with room for 24 large smartphones up to 6".



Item: 890700

Water analysis set, VISOCOLO

New test kit for water analysis, replacing the well-known Eco Test Kit from Aquanal (890600 - discontinued by manufacturer).



Item: 890701

Refill for Water analysis set, VI

Visicolor ECO is a test for water testing that has the analysis principle of visual colometry. Can also be used for seawater after diluting the sample 1:10.



Item: 890898

Water hardness, test sticks

Water analysis - Total hardness: Ca²⁺, Mg²⁺ 100 test sticks from Quantofix for semi-quantitative determination. The sticks consist of a 0.2 mm thick



Item: 890931

Winkler flask for oxygen test,

Winkler bottle, 30 mL with NS ground glass stopper. Can be used as a sample bottle for oxygen analysis. Accessory for ECO oxygen



Item: 896200-2

Zinc powder, 250 g

Synonym: Zinc Dust Formula: Zn Molecular Weight: 65.37 Purity: Pure CAS: 7440-66-6



Item: 896500-2

Zinc chloride, dry, 250 g

Formula: ZnCl₂ Molecular weight: 136.28 Purity: Pure CAS: 7646-85-7



Item: 888700-4

Triethanolamin, vandklar

Synonym: Tris(2-hydroxyethyl)amin Formel: N(CH₂CH₂OH)₃ & nbsp; Molvægt: 149,19 CAS: 102-71-6



Item: 398600

USB cable A / B (large)

Used for communication with the 518500 Multi-Channel Analyzer, among others.



Item: 767100

Settling cone

Sludge glass for measuring sedimentation and precipitation. Made of clear plastic with graduation up to 1000 mL.



Item: 767110

Stand for settling cone

Made of wood with space for 2 sight glasses. Designed so that there is a clear view of the entire sight glass. Supplied without sight glass (



Item: 031090

Test Tube Stand, Ø33 mm, 3 x 4

Test tube rack in plastic-coated metal wire Number of compartments: 3 x 4 Compartment diameter: 33 mm Height: 70 mm



Item: 055173

Cap for Blue Cap GL45

GL45 cap for Blue Cap reagent bottles and stand-up bottles. Standard size to fit bottles from different manufacturers.



Item: 449830

Plate electrode, iron

These metal plates are designed for use in teaching experiments with electrolysis, galvanic elements and voltage series. With their convenient size and flat



Item: 451000

Round electrode, copper

Round electrode - COPPER. 6-7 mm diameter - suitable for electrode holder no. 451510 and 451520, and electrode switch no. 451300. Fits in standard rubber plugs



Item: 451010

Round electrode, nickel

Round electrode - NIKKEL. 6-7 mm diameter - suitable for electrode holder no. 451510 and 451520, and electrode switch no. 451300. Fits in standard rubber plugs with



Item: 451020

Round electrode, aluminium

Round electrode - ALUMINIUM. Diameter of 6-7 mm - suitable for electrode holder no. 451510 and 451520, and electrode switch no. 451300. Fits in standard



Item: 451030

Round electrode, tin

Round electrode - TIN. Diameter of 6-7 mm - suitable for electrode holder no. 451510 and 451520, and electrode switch no. 451300. Fits in standard rubber plugs



Item: 451040

Round electrode, iron

Round electrode - IRON. Diameter of 6-7 mm - suitable for electrode holder no. 451510 and 451520, and electrode switch no. 451300. Fits in standard rubber plugs



Item: 451050

Round electrode, carbon

Synonyms: Carbon rods
Round electrode - KUL. Diameter of 6-7 mm - suitable for electrode holder no. 451510 and 451520, and electrode switch no. 451300.



Item: 451060

Round electrode, zinc

Round electrode - ZINK. Diameter of 6-7 mm - suitable for electrode holder no. 451510 and 451520, and electrode switch no. 451300. Fits in standard rubber plugs



Item: 451300

Electrode connector

Electrode switch for electrodes up to \varnothing : 7.5 mm. Made of acid-proof plastic. Holder with contact screw suitable for standard safety cables.



Item: 451520

Electrode Holder, Double, for R

Double electrode holder for two round electrodes up to 7.5 mm, made of acid-resistant plastic. Comes with stainless steel rod (diameter 10 mm) for mounting in tripod



Item: 010420

Distillation Flask with Side Ar

Borosilicate glass distillation flask with side arm for quick and easy distillation set-up
Volume: 500 mL
Inner diameter: 23 mm



Item: 014401

Auto dispenser for hand spray

Automatic dispenser for hand sanitizer – High-quality dispenser with sensor-controlled pump that ensures hygienic and touch-free use. When the hand is passed



Item: 053000

Plastic Box, Square, 50 mL

Square can with wide neck and screw cap. Made of natural colored HDPE. Black PP screw cap with PE foam insert.



Item: 102810

Digital scale, 15.0 kg / 1.0 g

Digital scale in a sleek design with large weighing plate and easy-to-read LCD display. Tare function.
Weighing range: 0-15,000



Item: 037525

Gas Tubing, Ø8/15 mm, 10 m

Gas hose approved for use with LPG, natural gas and city gas. Complies with European standard EN-16436-1.
Inner/outer diameter: 8/15



Item: 037530

Gas tubing, Ø8/15 mm, 30 m (

Gas hose approved for use with LPG, natural gas and city gas. Complies with European standard EN-16436-1.
Inner/outer diameter: 8/15



Item: 449800

Plate electrode, copper

These metal plates are designed for use in teaching experiments with electrolysis, galvanic elements and voltage series. With their convenient size and flat



Item: 449805

Plate electrode, aluminium

These metal plates are designed for use in teaching experiments with electrolysis, galvanic elements and voltage series. With their convenient size and flat



Item: 054710

Lab Bottle, 100 mL, GL45 Cap,

Lab bottles from our economy glass series. The bottles are made of heat-resistant borosilicate glass with plastic pouring ring and GL45 blue screw cap. Suitable as



Item: 012305

Test Tube without Lip, Ø6 x 35

Mini-reagent glass in AR glass with a thickness of 0.65 mm
Outer Diameter: 6 mm Height: 35 mm



Item: 012310

Test tube w. rim, Ø10x75 mm.

Small test tubes with collar made of heat-resistant glass.
Outer Diameter: 10 mm.
Height: 75 mm.
Rubber stoppers that

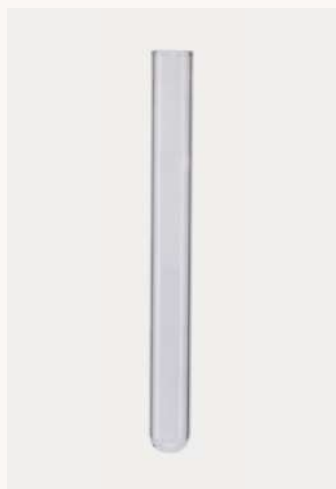

Item: 012325

Test Tube without Lip, Ø16 x 15

Test tube made of heat-resistant glass
Outer diameter: 16 mm
Inner diameter: 13 mm
Height: 180



Item: 012340

Test Tube, Ø16 x 160, Duran, Ri

Test tubes made of heat-resistant glass. DURAN.
Outer Diameter: 16 mm
Height: 160 mm
Pack of 100



Item: 704220

Utility Knife, Large, Pack of 10

Model with break-off blade.
Pack of 10 pieces.



Item: 890825

Ammonium test strip, 0.5 - 6

With these test sticks you can easily and quickly measure the ammonium content in water samples. The tests are semi-quantitative and require no equipment other than the



Item: 890828

Ammonium test strip, 0 - 400

Water analysis - Ammonium: NH_4^+
100 test sticks from Quantofix for semi-quantitative determination. The sticks



Item: 890838

Iron test strip, 0 - 1000 mg, Fe

Water analysis - Iron 1000: $\text{Fe}_2^+ / \text{Fe}_3^+$
100 test sticks from Quantofix for semi-quantitative determination. The sticks



Item: 890848

Copper test strip, 0 - 300 mg/

Water analysis - Copper: $\text{Cu}^+ / \text{Cu}^{2+}$ 100 test sticks from Quantofix for semi-quantitative determination. The rods consist of a 0.2 mm thick plastic foil 6x95 mm with



Item: 890880

Ozone test strip, 90-210 $\mu\text{g/L}$

For measuring ozone in air. Box of 12 ozone test sticks. Easy to use: Place the test stick on the measurement site. 10 minutes later compare with the color scale



Item: 865700-5

Sodium acetate, technical, 100

Sodium acetate is a versatile chemical that you can use in both classical chemistry experiments and interdisciplinary experiments. It is especially known for its



Item: 086070

Latex gloves, small, powder-fr

Powder-free latex glove with rolled edge. The thin material ensures a close fit with high dexterity, perfect for laboratory work and other work involving handling



Item: 086071

Latex gloves, medium, powder

Powder-free latex glove with rolled edge. The thin material ensures a close fit with high dexterity, perfect for laboratory work and other work involving handling



Item: 086072

Latex gloves, large, powder-free

Powder-free latex glove with rolled edge. The thin material ensures a close fit with high dexterity, perfect for laboratory work and other work involving handling



Item: 086073

Latex gloves, x-large, powder-free

Powder-free latex glove with rolled edge. The thin material ensures a close fit with high dexterity, perfect for laboratory work and other work involving handling



Item: 883010-4

Hydrochloric acid, 0.1 M, 1 L

0.1M Hydrochloric acid - aqueous solution. Formula: HCl Molecular Weight: 36.46 Purity: Pure CAS: 7647-01-0



Item: 883110-4

Hydrochloric acid, 1 M, 1 L

About 3.55% Hydrochloric acid - aqueous solution Formula: HCl Molecular Weight: 36.46 Purity: Pure CAS: 7647-01-0



Item: 883140-4

Hydrochloric acid, 4 M, 1 L

About 13.2% Hydrochloric acid - aqueous solution Formula: HCl Molecular Weight: 36.46 Purity: Pure CAS: 7647-01-0



Item: 883300-6

Sand, 4 kg

Quartz sand. Grain size: 0.4-0.8 mm



Item: 884700-2

Starch, soluble, 200 g

Polysaccharide. Formula: $(C_6H_{10}O_5)_n$ CAS: 9005-84-9



Item: 885158

Sugars, 6 different types

6 cans of 100 ml with different sugars. Fructose 80g, galactose 25g, glyucose 80g, lactose 60g, maltose 60g, sucrose 60g. Supplied in a plastic box with



Item: 885250

Sulfo soap

Sulfos soap in plastic bottle



Item: 885610-6

Sulphuric acid 1 M, 5 L

About 9.8% Sulfuric acid.
Formula: H_2SO_4 Molecular Weight: 98.08 Purity: Pure
CAS: 7664-93-9



Item: 576678

Foam insert with 30 spaces fo

Easy and safe storage of smartphones during class time. Practical foam insert with room for 30 smartphones.



Item: 032050

Pipette Stand, PP, Round, 94 C

Practical and space-saving stand for full pipettes, measuring pipettes and rod thermometers. Grooves in the base collect any liquids from the



Item: 000600

Retort stand base, tripod, 1.0 k

Tripod base "Tripod". Painted cast iron with hole (\varnothing : 10 mm) and clamping screw. Equipped with rubber legs. Weight: 1 kg



Item: 000800

Retort stand rod, 150 cm

Stand pole. Made of solid, centerless ground stainless steel. Turned to minimum diameter at both ends. Diameter \varnothing : 12/10 mm



Item: 000810

Retort stand rod, 100 cm

Stand pole. Made of solid, centerless ground stainless steel. Turned to minimum diameter at both ends. Diameter: 12/10 mm Length:



Item: 000820

Retort stand rod, 75 cm

Stand pole. Made of solid, centerless ground stainless steel. Turned to minimum diameter at both ends. Diameter: 12/10 mm Length:



Item: 000830

Retort stand rod, 50 cm

Stand pole. Made of solid, centerless ground stainless steel. Turned to minimum diameter at both ends.
Diameter: 12/10 mm Length:



Item: 000840

Retort stand rod, 60 cm

Stand pole. Made of solid, centerless ground stainless steel. Turned to minimum diameter at both ends.
Diameter: 12/10 mm Length:



Item: 000850

Retort stand rod, 25 cm

Stand pole. Made of solid, centerless ground stainless steel. Turned to minimum diameter at both ends.
Diameter: 12/10 mm Length:



Item: 000860

Retort stand rod, 10 cm

Stand pole. Made of solid, centerless ground stainless steel. Turned to minimum diameter at both ends.
Diameter: 12/10 mm Length:



Item: 001100

Experiment stand with flat bas

Plate base 10 x 18 cm in lacquered steel with rubber feet and 10 mm turned hole for the included 60 cm nickel-plated steel rod (Ø10 mm).



Item: 001510

Screw clamp

Screw clamp. Rust-protected and equipped with lacquered wooden handle.
Total length: 200 mm Max. gap: 150 mm



Item: 001600

Table clamp

Table clamp for clamping tripod poles to table edge. Made of lacquered aluminum die-cast. Holes for mounting rods up to 13 mm.



Item: 001800

Stand clamp with overlapping

Tripod clamp with fork grip from Usbeck. Metal die-cast. Can hold objects with diameters from 0 - 40 mm. Equipped with soft PVC coating on the



Item: 001805

Stand clamp, overlapping jaws

Tripod clamp with fork grip from Usbeck. Metal die-cast. Can hold objects with diameters from 0 - 25 mm. Equipped with soft PVC coating on the



Item: 001810

Stand clamp with rounded jaw

Rack clamp with round jaws from Usbeck. Made of lacquered die-cast zinc. Can hold items with diameters from 20 - 40 mm. Equipped with cork coating on the



Item: 001830

Stand clamp with angular jaws

Stand clamp with angular jaws from Usbeck. Made of lacquered die-cast zinc. Can hold objects with diameters from 13 - 40 mm. Equipped with cork coating on the



Item: 001840

Stand clamp, universal

Universal tripod clamp with lobed jaws from Usbeck. Made of lacquered die-cast zinc. Quick-clamping device with double thread. Can clamp items with a diameter



Item: 002200

Burette holder for 2

Double burette clamp made of aluminum suitable for two burettes. Burette diameter clamp ranges from 8 to 13 mm. The burettes are held in place with a spring clamp.

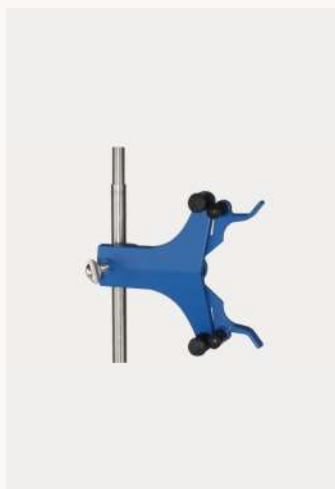

Item: 002210

Burette holder for 1, Alu

Aluminum burette clamp suitable for one burette. Burette diameter clamp ranges from 8 to 13 mm. The burettes are held in place with a spring clamp. Due to the



Item: 002300

Boss head

Double stand sleeve made of lacquered die-cast zinc. Perpendicular mounting. Fits round and square tripod poles with Ø7 - 18 mm.



Item: 002310

Square boss head, Universal

Square socket made of lacquered aluminum. Perpendicular mounting. Universal sleeve for clamping tripod poles with Ø2-13 mm and plates of 1-13



Item: 002320

Boss head, swivel

Turnable double sleeve in painted die-cast zinc. Fits tripod poles with: Ø7 - 18 mm. Total length: 155 mm



Item: 002700

Stand clamp, with hook

Tripod sleeve with hook. Made of lacquered die-cast zinc with hook in nickel-plated brass. For clamping on tripod poles with diameter Ø7 - 18



Item: 002800

Stand clamp with Ø 10 mm so

Tripod sleeve with hole (Ø10 mm). For clamping items with 10 mm rod. Can be clamped on rods with Ø7 - 18 mm. Painted die-cast zinc.



Item: 003700

Laboratory Jack, Painted, 150

Good stable level table that works by scissor lift method with screw operation
Platform size: 150x135 mm
Maximum height: 25 cm Max



Item: 003710

Laboratory Jack, Painted, 200

Good stable level table that works by the scissor lift method with screw operation.

- Platform size: 200x200 mm



Item: 003900

Support ring Ø 120/105 mm

Cooking ring with sleeve for clamping on a tripod pole. Fits both 10 and 12 mm rods. The diameter of the ring is approx. 10.5 cm in inner



Item: 004100

Tripod, Ø10 cm, height 18 cm

Nickel-plated steel tripod
The nickel plating is a so-called "transport nickel plating" that is expected to gradually peel off.



Item: 004101

Tripod, Ø10 cm, 18 cm high

Trepod in stainless steel. By purchasing this tripod you get a very strong and chemical/thermal resistant tripod.



Item: 004110

Tripod Stand, height 21 cm

Nickel-plated steel tripod
The nickel plating is a so-called "transport nickel plating" that is expected to gradually peel off.



Item: 004111

Trefod, 21 cm høj, rustfri stål

Trepod in stainless steel. By purchasing this tripod you get a very strong and chemical/thermal resistant tripod.

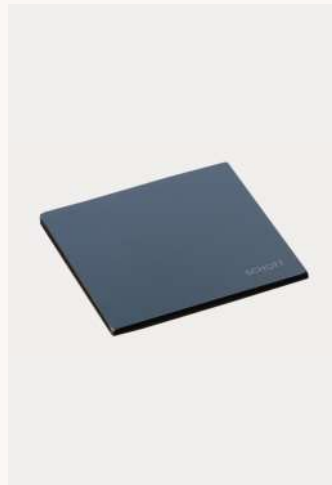

Item: 004310

Ceramic Plate, 135 x 135 mm

Glass ceramic protection plate. Used as a heat distributor under flat-bottomed flasks and beakers. Plate is placed on the stand and the flask or beaker is



Item: 004320

Ceramic Plate, 155 x 155 mm

Glass ceramic protection plate. Used as a heat distributor under flat-bottomed flasks and beakers. The plate is placed on the stand and the flask or beaker



Item: 0561052

Pipette for Pipette Flask 05610

Less pipette for dropper bottle 056105.



Item: 042035

Chromatography paper, 580 x

Chromatography paper MN 261. Suitable for the exercises in
Dimension: 58 x 60 cm



Item: 042500

Rubber stopper, grey, 5/9 mm

Rubber stopper without hole - gray rubber
Diameter: 5 / 9 mm Height: 20 mm
Tubes that fit:



Item: 888000-4

Tin in bars 1 kg

1 kg tin bars.
Ideal for classes that introduce students to metals and their properties, or for teaching material science and



Item: 004502

Bunsen Burner, Bottle Gas

Bunsen burner with gas and air regulation. Equipped with a pilot light. Gas type: Bottled gas. Gas pressure: 30 mbar. Power: 1.5 kW. Height: 145 mm. Weight: 275



Item: 004507

Bunsen burner with pilot light,

Bunsen burner with gas and air regulation. Equipped with a pilot light. Gas type: Natural gas. Gas pressure: 20 mbar. Power: 1.1 kW. Height: 150 mm. Weight: 283



Item: 004512

Bunsen Burner without Valve,

Bunsen burner without gas regulation, but with air regulation. For student use. Gas type: Bottled gas. Gas pressure: 30 mbar. Power: 1.4 kW. Height: 145 mm.



Item: 004517

Bunsen Burner without Adjust

Bunsen burner without gas regulation, but with air regulation. For student use. Gas type: Natural gas. Gas pressure: 20 mbar. Power: 1.25 kW. Height: 150 mm.



Item: 004519

Bunsen Burner with Pilot Light,

Bunsen burner for city gas with pilot flame. For student use. Gas type: City gas. Gas pressure: 8 mbar. Power: 1.0 kW. Height: 150 mm. Weight: 280



Item: 004550

Suction cup for bunsen burner

Handy and practical suction cup for securing different models of Bunsen burners. This suction cup is an indispensable accessory that



Item: 004712

Merkerburner, Bottle Gas

Bunker burner (Ø: 32 mm) with gas and air regulation. Gas type: Bottled gas. Gas pressure: 30 mbar. Power: 2.0 kW Consumption: 38 l/h.



Item: 005111

Gas Burner

New, improved gas burner with valve for use with standard gas canister. This burner features very precise regulation of the gas flow and a separate handle for



Item: 005150

Laboburner with container

Burner with safety valve. The burner is equipped with air regulation and needle valve for gas regulation. The gas canister, which contains 400 ml propane/butane, is



Item: 005155

Gas canister, 220 g

Handy and compact lightweight gas cylinder with threaded nozzle and ball valve, designed for easy and safe use in any



Item: 005205

Wick for alcohol lamp

Replacement wick for ethanol burner model 005200 – a practical solution to extend the life of your ethanolburner. When replacing the old wick,



Item: 005210

Alcohol Burner, glass

Classic glass ethanol burner with an integrated wick holder and a metal screw cap, designed for precise and safe use in laboratory environments. This alcohol



Item: 005300

Fuel tablets

Pack of 12 alcohol tablets – a practical and versatile solution for lighting fires and stoves, and cooking in the open air.



Item: 005400

Gas lighter with stone

The classic gas lighter with stone. The gas is ignited with a spark from the gas lighter, making the gas lighter an ideal way to save matches. At the same time, the gas lighter



Item: 053960

Cannula bucket, 1.5 L

Cannula container with lid with needle outlet. USON is a Danish-produced needle container designed for use in hospitals, clinics and



Item: 102923

Core weight EFS 2000-0, 200

Simple and easy 2-button operation and therefore suitable for school and educational use Large LCD display Special flat design makes this scale stackable



Item: 102922

Core weight EFS 600-1, 600 g

Simple and easy 2-button operation and therefore suitable for school and educational use Large LCD display Special flat design makes this scale stackable



Item: 541245

pH meter, (pH/mV)

Battery operated pH/mV meter with digital scale that has auto shut off after 4 min. suitable for field use and comes in a carrying case with electrode, battery and



Item: 056125

Pipette for Pipette Flask 05612

Screw cap with pipette for pipette bottles. Fits 50 ml bottle (order no. 056120).



Item: 056130

Pipette Flask, 100 mL

Brown glass pipette bottle fitted with glass pipette with rubber ball in screw cap. Volume: 100 ml



Item: 056136

Pipette for Pipette Flask 05613

Screw cap with pipette for pipette bottles. Fits 100 ml bottle (order no. 056130).



Item: 056203

Dropper bottle, plastic, 30 mL

Semi-translucent polyethylene dropper bottle. Screw cap with dropper tip and cap. Volume: 30 mL



Item: 056210

Dropper bottle, plastic, 50 mL

Semi-translucent polyethylene dropper bottle. Screw cap with dropper tip and cap. Volume: 50 mL Ø: 38 mm



Item: 056220

Dropper bottle, plastic 100 ml

Semi-translucent polyethylene dropper bottle. Screw cap with dropper tip and cap. Volume: 100 mL Ø: 47 mm



Item: 056600

Sample holder with snap lid 1.7

Small glasses with snap-on lids.



Item: 899322

GHS Pictograms, Corrosion, 2

These labels are made of PE film and display the GHS symbols, in accordance with the GHS regulations for chemical substances and mixtures. The GHS symbols



Item: 899324

GHS Pictograms, Health hazard

These labels are made of PE film and display the GHS symbols, in accordance with the GHS regulations for chemical substances and mixtures. The GHS symbols



Item: 899325

GHS Pictograms, Harmful, 26x

These labels are made of PE film and display the GHS symbols, in accordance with the GHS regulations for chemical substances and mixtures. The GHS symbols



Item: D100350

Glycerol 99%.

Formula: (HOCH₂)₂CHOH,
1,2,3-Propanetriol, Glycerine
Mol Weight: 92.09
CAS: 56-81-5
EC:



Item: 055183

Retaining ring for Blue Cap GL

Blue GL45 pouring ring for Blue Cap reagent bottles and stand-up bottles. Standard size to fit bottles from different manufacturers.



Item: 803600-6

Ammonium chloride, 1 kg

Sal ammoniac powder.
Formula: NH₄Cl.
Molecular weight: 53.49.
Purity: 99%.
CAS:



Item: 576694

Gratnells metal runners, grey,

Gratnell guide rails for shelving and system trolleys. Used for mounting system trays. Sold in pairs
Color: Gray



Item: 005401

Stone for gas lighter, pk. 10 pc

New stones for gas lighter. Fits gas lighter no. 005400. To install, loosen the screw on the gas lighter, remove the old stone and install the new



Item: 005500

Lighter

An ordinary tea light lighter for lighting candles in storm lamps and more. Good for younger students as the risk of burning their fingers is minimal. The lighter has a



Item: 005600

Matches, large

1 pack of large matches. Approx. 7 x 5 x 2.5 cm. Sold in quantity of 3 packs. (If you want a frame, you need to buy 36 packs. For a full



Item: 006000

Cylinder flask, 15 x Ø5 cm

Cylinder glass with round base and flame polished edge Height: 15 cm Outer diameter: 50 mm Inner



Item: 855450-3

Activated carbon, powder

CAS No.: 7440-44-0
250 g.



Item: 069540

Vacuum Oil - 500ml

Standard vacuum oil, used e.g. as a refill in Vacuum Pump 069525.



Item: 013130

Micro capillar, 20 µL (100 pcs)

Fixed volume capillary tube, where the liquid is sucked up using hair tube action. The liquid is squeezed out by pressing the top of the suction



Item: 866605-4

Natriumcarbonat, 10H₂O

Synonym: Crystalline Soda
Formula: Na₂CO₃ · 10H₂O
Molecular Weight: 286.14
Purity: 99.5% CAS: 6132-02-1



Item: 807400-2

Bariumhydroxid oktahydrat

Formula: $Ba(OH)_2 \cdot 8H_2O$
 Molecular Weight: 315.47
 Purity: Technically Pure > 94%
 CAS: 12230-71-6



Item: 022305

Test Tube with Screw Top, Ø16

Test tubes with round base and solid wall thickness for reusability. With GL 18 thread and screw cap. Diameter: 16 mm. Length: 100 mm



Item: 041000

Cork ring for round-bottom fla

Cork ring suitable for round-bottomed glass flasks from 250 mL to 2000 mL.
 Outer diameter: 110 mm



Item: 041100

Plastic stand for round-bottom

Foot for round flasks up to 1 L. Stackable and autoclavable.
 OBS: Made of PP plastic, so not suitable for hot objects!



Item: 899327

GHS Pictograms, Flammable,

These labels are made of PE film and display the GHS symbols, in accordance with the GHS regulations for chemical substances and mixtures. The GHS symbols



Item: 899329

GHS Pictograms, Oxidizing, 26

These labels are made of PE film and display the GHS symbols, in accordance with the GHS regulations for chemical substances and mixtures. The GHS symbols



Item: 901350

Waste wagon, complete

The situation is probably familiar. You have chemical waste of one kind or another and even if it's in small quantities, you have a little trouble disposing of it



Item: 901360

Waste stand, slanting table m

Practical stand for used pipette tips, used microtubes and other small waste. Smart and more spacious alternative to beakers and the like. With white poly coating.



Item: 901362

Autoclave bag for waste stand

Heavy-duty polypropylene bags that withstand autoclaving. "Hazardous" waste collected in the 901360 waste rack can thus be easily neutralized in the



Item: 901370

Waste Bucket, 30 L, for Flamm

30L metal waste bin designed as a barrel with a small opening. Suitable for flammable waste. Made of stainless



Item: 901380

Floor stand for wiping paper

Floor stand with epoxy coating withstands water, oil, dirt, etc. Max paper width 40cm

- Width: 40cm



Item: 045050

Rubber stopper 31/38x35 mm

Conical rubber plugs with 9 mm hole for yeast tubes made of red natural rubber. Can be used at temperatures from -30 to 60 °C



Item: 832150-8

Glycerol, 99%, 100mL i dråbefl

Glycerol (also known as propane-1,2,3-triol or glycerin) is a viscous, colorless liquid that you can use in many different educational experiments. This



Item: 006020

Cylinder flask, 20 x Ø6 cm

Cylinder glass with round base and flame polished edge
Height: 20 cm Outer diameter: 60 mm Inner



Item: 006600

Glassplate, 7 x 7 x 0,2 cm

Thin glass cover plate that can be used as a lid for cylinder jars. The glass has ground edges to prevent cuts. The plate can be used for



Item: 006800

Glass Beaker, Tall Form, 50 mL

Beaker - tall shape. Made of borosilicate glass 3.3, with division.
Content: 50 ml Diameter: 38 mm Height: 70 mm



Item: 006810

Glass Beaker, Tall Form, 100 m

Beaker - tall shape. Made of borosilicate glass 3.3 with division

Content: 100 ml Diameter: 47 mm Height: 80 mm



Item: 006830

Glass Beaker, Tall Form, 250 m

Beaker - tall shape. Made of borosilicate glass 3.3 with division.

Content: 250 ml Diameter: 60 mm Height: 120 mm



Item: 006850

Glass Beaker, Tall Form 500 m

Beaker - tall shape. Made of borosilicate glass 3.3 with division.

Content: 500 ml Diameter: 77 mm Height: 137 mm.



Item: 006860

Glass Beaker, Tall Form, 1000

Beaker - tall shape. Made of borosilicate glass 3.3, with division.

Content: 1000 ml Diameter: 95 mm Height: 180 mm



Item: 006950

Glass Beaker, Tall Form, 600 m

Beaker - high form in the best quality. Made of borosilicate glass with division.

Content: 600 ml Diameter: 82 mm Height: 143 mm



Item: 006960

Glass Beaker, Tall Form, 1000

Beaker - high form in the best quality. Made of borosilicate glass with division.

Content: 1000 ml Diameter: 95 mm Height: 185 mm



Item: 006970

Glass Beaker, Tall Form, 2000

Beaker - high form in the best quality. Made of borosilicate glass with division.

Content: 2000 ml Diameter: 118 mm Height: 236 mm



Item: 006980

Glass Beaker, Tall Form, 3000

Beaker - high form in the best quality. Made of borosilicate glass with division.

Content: 3000 ml Diameter: 135 mm Height: 280 mm



Item: 007400

Glas Beakers, Low Form, 25 m

Beaker - low shape. Made of borosilicate glass with division.

Content: 25 ml Diameter: 34 mm Height: 50 mm



Item: 007410

Glas Beakers, Low Form, 50 m

Beaker - low shape. Made of borosilicate glass with division.

Content: 50 ml Diameter: 42 mm Height: 60 mm



Item: 007420

Glas Beakers, Low Form, 100

Beaker low shape. Made of borosilicate glass. With division.

Content: 100 ml Diameter: 50 mm Height: 70 mm



Item: 007430

Glas Beakers, Low Form, 250

Beaker low shape. Made of borosilicate glass. With division.

Content: 250 ml Diameter: 70 mm Height: 95 mm



Item: 007435

Glas Beakers, Low Form, 400

Beaker low shape. Made of borosilicate glass. With volume division and frosted writing field.

Low form beakers are



Item: 007440

Glas Beakers, Low Form, 600

Beaker low shape. Made of borosilicate glass. With division.

Content: 600 ml Diameter: 90 mm Height: 125 mm



Item: 007450

Glas Beakers, Low Form, 1000

Beaker low shape. Made of borosilicate glass. With division.

Content: 1000 ml Diameter: 105 mm Height: 145 mm



Item: 007460

Glas Beakers, Low Form, 2000

Beaker low shape. Made of borosilicate glass. With division.

- Content: 2000 ml



Item: 007470

Glas Beakers, Low Form, 5000

Beaker low shape. Made of borosilicate glass. With division.

Content: 5000 ml Diameter: 170 mm Height: 270 mm



Item: 007480

Glas Beakers, Low Form, 5 mL

DURAN beaker, low shape. Made of borosilicate glass with division.

Volume: 5 ml Diameter: 20 mm Height: 30 mm



Item: 007490

Glas Beakers, Low Form, 10 mL

DURAN beaker, low shape. Made of borosilicate glass with division.

Volume: 10 ml Diameter: 26 mm Height: 35 mm



Item: 007500

Glas Beakers, Low Form, 25 mL

DURAN beaker, low shape. Made of borosilicate glass with division.

Volume: 25 ml Diameter: 32 mm Height: 48 mm



Item: 007510

Glas Beakers, Low Form, 50 mL

DURAN beaker, low shape. Made of borosilicate glass with division.

Volume: 50 ml Diameter: 39 mm Height: 55 mm



Item: 007520

Glas Beakers, Low Form, 100

DURAN beaker, low shape. Made of borosilicate glass with division.

Volume: 100 ml Diameter: 51 mm Height: 71 mm



Item: 007530

Glas Beakers, Low Form, 250

DURAN beaker, low shape. Made of borosilicate glass with division.

Volume: 250 ml Diameter: 69 mm Height: 95 mm



Item: 007540

Glas Beakers, Low Form, 600

DURAN beaker, low shape. Made of borosilicate glass with division.

Volume: 600 ml Diameter: 92 mm Height: 115 mm



Item: 007550

Glas Beakers, Low Form, 1000

DURAN beaker, low shape. Made of borosilicate glass with division.
Volume: 1000 ml Diameter: 106 mm Height: 145 mm



Item: 007560

Glas Beakers, Low Form, 2000

DURAN beaker, low shape. Made of borosilicate glass with division.
Volume: 2000 ml Diameter: 132 mm Height: 185 mm



Item: 007720

Beaker, plastic, 100 mL

Polypropylene (PP) beaker - low shape. With collar, pouring spout and division. High translucency. Autoclavable (max. 135°C)



Item: 007730

Beaker, plastic, 250 mL

Polypropylene (PP) beaker - low shape. With collar, pouring spout and division. High translucency. Autoclavable (max. 135°C)



Item: 007740

Beaker, plastic, 400 mL

Polypropylene (PP) beaker - low shape. With collar, pouring spout and division. High translucency. Autoclavable (max. 135°C)



Item: 007750

Beaker, plastic, 600 mL

Polypropylene (PP) beaker - low shape. With collar, pouring spout and division. High translucency. Autoclavable (max. 135°C)



Item: 007760

Beaker, plastic, 1000 mL

Polypropylene (PP) beaker - low shape. With collar, pouring spout and division. High translucency. Autoclavable (max. 135°C)



Item: 007900

Erlenmeyer flask, 100 mL, boro

Conic flask (Erlenmeyer flask) from Borosil. Made of heat-resistant borosilicate glass, with division. Content: 100 ml



Item: 007910

Erlenmeyer flask, 250 mL, bor

Conical flask (Erlenmeyer flask) from Borosil. Made of heat-resistant borosilicate glass, with graduation.

- Content: 250 ml



Item: 007920

Erlenmeyer flask, 500 mL, bor

Conical flask (Erlenmeyer flask) from Borosil. Made of heat-resistant borosilicate glass, with division.

- Content: 500 ml



Item: 007930

Erlenmeyer flask, 1000 mL, bor

Conical flask (Erlenmeyer flask) from Borosil. Made of heat-resistant borosilicate glass, with graduation.

Content: 1000 ml



Item: 007940

Erlenmeyer flask, 2000 mL, bo

Conical flask (Erlenmeyer flask) from Borosil. Made of heat-resistant borosilicate glass, with graduation.

Content: 2000 ml



Item: 007950

Erlenmeyer flask, 5000 mL, bo

Conical flask (Erlenmeyer flask) from Borosil. Made of heat-resistant borosilicate glass, with division.

Content: 5000 ml



Item: 007992

Erlenmeyer flask, DURAN, 25

Conical flask (Erlenmeyer flask). Made of DURAN borosilicate glass. Volume: 25 ml Inner diameter neck: 19 mm Height: 72 mm



Item: 007995

Erlenmeyer flask, DURAN, 50

Conical flask (Erlenmeyer flask). Made of DURAN borosilicate glass. With graduation.

Volume: 50 ml Inner neck



Item: 008000

Erlenmeyer flask, DURAN, 100

Conical flask (Erlenmeyer flask). Made of DURAN borosilicate glass. With graduation.

Volume: 100 ml Inner neck



Item: 008010

Erlenmeyer flask, DURAN, 250

Conical flask (Erlenmeyer flask). Made of DURAN borosilicate glass. With division.
Volume: 250 ml Inner neck

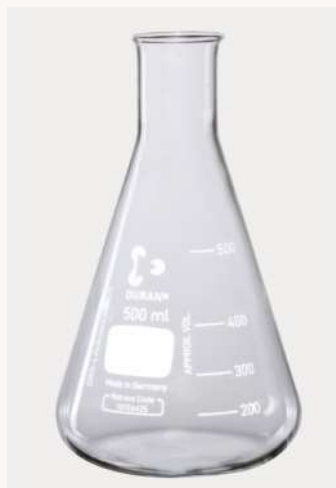

Item: 008020

Erlenmeyer flask, DURAN, 500

Conical flask (Erlenmeyer flask). Made of DURAN borosilicate glass. Volume: 500 ml Inner neck diameter: 30 mm Height: 175 mm



Item: 008030

Erlenmeyer flask, DURAN, 1000

Conical flask (Erlenmeyer flask). Made of DURAN borosilicate glass. Volume: 1000 ml Inner neck diameter: 38 mm Height: 220 mm



Item: 008040

Erlenmeyer flask, DURAN, 2000

Conical flask (Erlenmeyer flask). Made of DURAN borosilicate glass. Volume: 2000 ml
Rubber stoppers to fit:

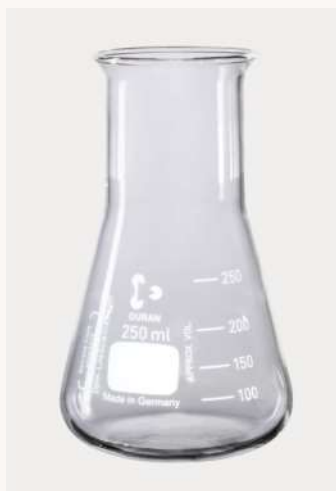

Item: 008100

Erlenmeyer Flask, Wide Neck,

Conical flask (Erlenmeyer flasks) with wide neck. Made of DURAN borosilicate glass, and with 50 ml graduation.
Volume: 250 ml Inner neck



Item: 008110

Erlenmeyer Flask, Wide Neck,

Conical flask (Erlenmeyer flask) with wide neck. Made of DURAN borosilicate glass. Volume: 500 ml Neck diameter: 46 mm Height: 175



Item: 008120

Erlenmeyer Flask, Wide Neck,

Conical flask (Erlenmeyer flask) with wide neck. Made of DURAN borosilicate glass. Volume: 1000 ml Neck diameter: 46 mm Height: 220



Item: 008410

Round flask, 250 mL, Borosil

Round flask from Borosil. Made of chemical, thermal and mechanical resistant borosilicate glass
Volume: 250 ml Inner neck



Item: 008420

Round flask, 500 mL, Borosil

Round flask from Borosil. Made of chemical, thermal and mechanical resistant borosilicate glass
Volume: 500 ml Neck



Item: 008510

Round flask, DURAN, 250 mL

Round flask. Made of DURAN borosilicate glass
Volume: 250 ml Inner neck diameter: 31 mm Height: 145 mm



Item: 008520

Round flask, DURAN, 500 mL

Round flask. Made of DURAN borosilicate glass
Volume: 500 ml Inner neck diameter: 31 mm Height: 175 mm



Item: 008530

Round flask, DURAN, 1000 mL

Round flask. Made of DURAN borosilicate glass
Volume: 1000 ml Neck diameter: 48 mm Height: 210 mm



Item: 009420

Flat bottom flask, 500 mL, Bor

Round flask with flat bottom. Made of borosilicate.
Volume: 500 ml Inner neck diameter: 28 mm Height: 170 mm



Item: 009430

Flat bottom flask, 1000 mL, Bo

Round flask with flat bottom. Made of borosilicate.
Volume: 1000 ml Neck diameter: 42 mm Height: 200 mm



Item: 009440

Flat bottom flask, 2000 mL, Bo

Round flask with flat bottom. Made of borosilicate.
Volume: 2000 ml Neck diameter: 50 mm Height: 250 mm



Item: 009520

Flat bottom flask, 500 mL, DU

Round flask with flat bottom. Made of DURAN borosilicate.
Volume: 500 ml Inner neck diameter: 30 mm Height: 170 mm



Item: 010020

Büchner Flask, DURAN, 250 m

Büchner Flask. Thick-walled conical flask with side spout and polypropylene cone. The spout is equipped with a quick coupling. Made of Duran



Item: 010030

Büchner Flask, DURAN, 500 m

Büchner Flask. Thick-walled conical flask with side spout and polypropylene cone. The spout is equipped with a quick coupling. Made of Duran



Item: 010100

Spigot connector for Duran B

Spare part for Duran suction pistons. Plastic spigot that can be screwed onto the suction piston.



Item: 010410

Distillation Flask with Side Ar

Borosilicate glass distillation flask with side arm for quick and easy distillation set-up
Volume: 250 mL
Inner diameter: 21.5 mm



Item: 010700

Volumetric Flask, 50 mL, Boro

Borosilicate glass volumetric flask with polypropylene stopper
Each flask is individually machine calibrated at 20°C



Item: 010710

Volumetric Flask, 100 mL, Boro

Borosilicate glass volumetric flask with polypropylene stopper
Each flask is individually machine calibrated at 20°C



Item: 010720

Volumetric Flask, 250 mL, Bor

Borosilicate glass volumetric flask with polypropylene stopper
Each flask is individually machine calibrated at 20°C



Item: 010730

Volumetric Flask, 500 mL, Bor

Borosilicate glass volumetric flask with polypropylene stopper
Each flask is individually machine calibrated at 20°C



Item: 010740

Volumetric Flask, 1000 mL, Bor

Borosilicate glass volumetric flask with polypropylene stopper
Each flask is individually machine calibrated at 20°C



Item: 011020

Graduated cylinder, tall, 10 mL

Measuring glass in a tall shape. Made of glass, with pouring spout and hexagonal base for stability.
The division on the glass is



Item: 011030

Graduated cylinder, tall, 25 mL

Gauge glass in a tall shape. Made of glass, with pouring spout and hexagonal base for stability.
The division on the glass is



Item: 011040

Graduated cylinder, tall, 50 mL

Gauge glass in a tall shape. Made of glass, with pouring spout and hexagonal base for stability.
The division on the glass is



Item: 011050

Graduated cylinder, tall, 100 mL

Gauge glass in a tall shape. Made of glass, with pouring spout and hexagonal foot for stability.
The division on the glass is



Item: 011060

Graduated cylinder, tall, 250 mL

Gauge glass in a tall shape. Made of glass, with pouring spout and hexagonal foot for stability.
The division on the glass is



Item: 011070

Graduated cylinder, tall, 500 mL

Graduated cylinder in a tall shape. Made of glass, with pouring spout and hexagonal foot for stability.
The division on the glass is



Item: 011080

Graduated cylinder, tall, 1000 mL

Graduated cylinder in a tall shape. Made of glass, with pouring spout and hexagonal foot for stability.
The division on the glass is

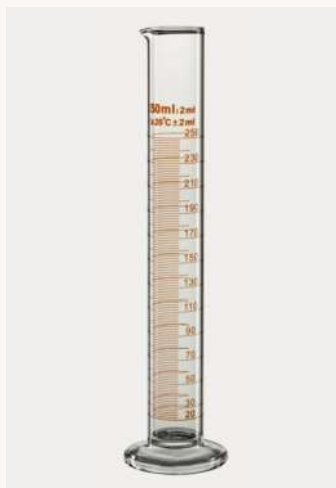

Item: 011260

Graduated cylinder, tall, 250 ml

High-form measuring glass made of heat-resistant borosilicate glass with spout and round base.
Volume: 250 ml



Item: 011510

Graduated cylinder, low form, 1

Measuring glass - low shape. Made of glass with round base.
The division on the glass is fused on, making it chemical



Item: 047130

Stopper, PE, with NS 24/29

Stopper with normal grinding for standpipes and volumetric flasks. Made of polyethylene.
NS grind: 24/29 mm
Fitting flasks:



Item: 047140

Stopper, PE, with NS 29/32

Stopper with normal grinding for standpipes and volumetric flasks. Made of polyethylene.
NS grit: 29/32 mm
Fits these flasks and others:



Item: 047490

Cork stopper, 8/10 x 19 mm

Cork stopper. Diameter: 8/10 mm. Height: 19 mm.



Item: 047500

Cork stopper, 11/14 x 22 mm

Cork stopper. Diameter: 11/14 mm. Height: 22 mm.



Item: 047510

Cork stopper, 15/21 x 25 mm

Cork stopper. Diameter: 15/21 mm. Height: 25 mm.



Item: 047515

Cork stopper, 18/22 x 25 mm

Cork stopper. Diameter: 18/22 mm. Height: 25 mm.



Item: 047520

Cork stopper, 21/28 x 25 mm

Cork stopper. Diameter: 21/28 mm. Height: 25 mm.



Item: 048000

Cork Borers

Drills for plugs. Set of 6 different diameters (Ø 4-10 mm).



Item: 048100

Bore for Stoppers, 4 - 15 mm

Bore for stoppers with the ability to make plugs with 9 different diameters in the range 4-15 mm.



Item: 048500

Wooden splints, Ø2 x 145 mm

Can be used as glow sticks or swabs
Material: Wood Diameter: 2 mm Length: 145 mm



Item: 049490

Glass Rod, Ø3 x 200 mm

Glass rod. Can be used as a stirring stick or for grafting
Diameter: 3 mm Length: 200 mm



Item: 049500

Spatula, glass, Ø5 x 200 mm

Glass spatula. Length: 200 mm. Handle Ø: 5 mm. Plate Ø: 12 mm.



Item: 049600

Spatula, Stainless Steel, 15cm

Stainless steel spatula. 15 cm long with 8 mm blade.



Item: 050000

Plastic spatula, Ø2 x 120 mm

Plastic spatula. Length: 120 mm. Width: 2 mm.
Can be used as a spatula or as a swab.



Item: 050700

Magnesium rods

Used as an alternative to nickel spatula for flame color/spectral color tests. Magnesia is characterized by being porous so it can absorb the substance for flame color



Item: 051010

Spatula, s/s, spoon one end, 1

Practical spoon with spatula for use when weighing chemicals. Length: 15 cm.



Item: 051050

Spoon, Stainless, 150 mm, 15 x

Spoon made of stainless steel.
Length: 150 mm Spoon: 15 x 30 mm



Item: 051510

Powder scoop, plastic, 10 mL

Powder spoon in plastic
Volume: 10 ml Length: 105 mm Width: 34 mm



Item: 051520

Powder scoop, plastic, 50 mL,

Powder spoon in plastic
Volume: 50 ml Length: 160 mm Width: 55 mm



Item: 060020

Thermometer without scale 23

This thermometer is without a scale on a metal background and is used to investigate thermometer fluctuations, allowing students to apply a scale themselves.



Item: 860101

Magnesium band, roll

25 grams of magnesium in strips.

- Width approx. 4 mm.
-
- Formula: Mg.



Item: 860900-3

Magnesiumsulfat, teknisk

Magnesium sulfate for chemical analysis
Synonym: Epsom salt
Formula: $MgSO_4$
Molecular weight:



Item: 862700-8

Methylenblåt, 0,05 %, i dråbefl

Microscopy: For staining bacteria and yeast cells
0.05% solution
Chemical formula:
 $C_{16}H_{18}ClN_3S$ -



Item: 863508

2-Methyl-2-propanol

Synonym: Tert.Butanol
Formula: $(CH_3)_3COH$
Molecular weight: 74.12
Purity: 99% Melting point: 23-26 gr.C (can be melted over water bath) CAS:



Item: 865508

Sodium, pieces

Synonym: Sodium in petroleum (kerosene)
Formula: Na
Molecular weight: 22.99 Purity: 99%
CAS: 7440-23-5G



Item: 866700-4

Sodium chloride, fine, 1 kg

Synonym: Dairy Salt Formula:
NaCl Molecular Weight: 58.44
Purity: Pure CAS: 7647-14-5



Item: 867800-4

Sodium hydrogen carbonate, 1

Synonym: Baking Soda, Tvekulic acid
Formula: $NaHCO_3$ Molecular Weight: 84.01 Purity: Pure CAS: 144-55-8



Item: 052090

Bucket, plastic, 10 L

Bucket in impact resistant plastic (not PVC) with handle.
Volume: 10 Liter.



Item: 055712

Plastic bottle, 250 mL

Round model with narrow neck and tight-fitting red lid. Very robust type made of semi-transparent plastic that is resistant to most chemicals. Particularly



Item: 055780

Plastic Bottle with Flip Cap, 25

Round bottle with flip-top lid. Made of plastic (PE). Suitable for shampoo, lotion etc.
Content: 250 mL



Item: 056105

Pipette Flask, 5 mL

Brown glass pipette bottle fitted with glass pipette with rubber ball in screw cap. Volume: 10 ml



Item: 056110

Pipette Flask, 30 mL

Brown glass pipette bottle fitted with glass pipette with rubber ball in screw cap. Volume: 30 ml



Item: 056115

Pipette for Pipette Flask 05611

Screw cap with pipette for pipette bottles. Fits 30 ml bottle (order no. 056110).



Item: 039015

Tubing connector, Ø4-6 / 7-10

Double conical hose collector - different diameters. Made of impact-resistant acid-resistant plastic. Outer diameter Ø : 4-6/7-10



Item: 039020

T connector, Ø5-7 mm

Hose collector. T-pipe (large). Made of impact-resistant acid-resistant plastic. Outer diameter Ø5-7 mm



Item: 039110

Tube connector, Ø4.5-7 mm

Double conical hose collector. Made of impact-resistant acid-resistant plastic. Outer diameter Ø: 4.5-7/4.5-7



Item: 039120

Tubing connector, T, Ø3 mm

Hose collector. T-pipe (small). Made of impact-resistant acid-resistant plastic. Outer diameter Ø : 3 mm



Item: 039220

Y fitting, Ø10-13 mm

Hose collector. Y-pipe. Made of impact-resistant acid-resistant plastic. Outer diameter Ø : 10-13 mm



Item: 039510

Pinchcock, Mohr type, 60 mm

Hose clamp "Mohr". Clamp tap in nickel-plated steel. Length: 60 mm



Item: 039530

Screw clamp, Hoffmann

Hose clamp, Hofmann. Nickel-plated steel clamp tap. Length A: 17 mm



Item: 039540

Screw clamp, large, Hoffmann

Hose clamp, Hofmann (large). Nickel-plated steel clamp tap. Length A: 25 mm



Item: 040000

Glass cutting tool

Glass cutter with polished carbide wheels that can be replaced. For glass tubes with a diameter of 3-30 mm.



Item: 046000

Rubber stopper 41/49 x 40 m

Conical rubber plug without a hole made of gray natural rubber. Can be used at temperatures from -30 to 60 °C.



Item: 045540

Rubber stopper 36/44 x 40 m

Conical rubber stopper made of gray natural rubber. Can be used at temperatures from -30 to 60 °C. Diameter ϕ/ϕ : 36/44 mm.



Item: 901382

Paper roll 33 cm

Decking paper for use in the laboratory. 1-ply. Width: 33 cm. Length: 1190 m.

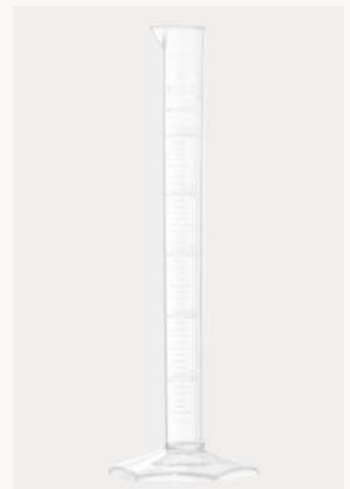

Item: 011810

Graduated cylinder, plastic, 10

Measuring glass in crystal clear PMP plastic. Tall shape, hexagonal base, autoclavable (121°C). The clear plastic is more



Item: 011820

Graduated cylinder, PP, 10 mL

Polypropylene measuring cylinder with plastic alloy that is mechanically strong and resistant to all commonly used liquids. Withstands

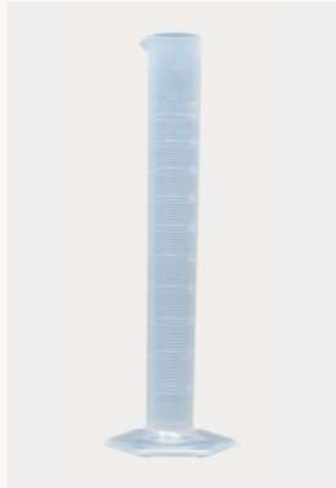

Item: 011821

Graduated cylinder, PP, 100 mL

Polypropylene measuring cylinder with plastic alloy that is mechanically strong and resistant to all commonly used liquids. Withstands



Item: 011822

Graduated cylinder, PP, 250 mL

Polypropylene measuring cylinder with plastic alloy that is mechanically strong and resistant to all commonly used liquids. Withstands



Item: 011823

Graduated cylinder, PP, 500 mL

Polypropylene measuring cylinder with plastic alloy that is mechanically strong and resistant to all commonly used liquids. Withstands



Item: 011824

Graduated cylinder, PP, 1000

Polypropylene measuring cylinder with plastic alloy that is mechanically strong and resistant to all commonly used liquids. Withstands



Item: 011830

Graduated cylinder, plastic, 25

Measuring glass in crystal clear PMP plastic. Tall shape. hexagonal base. autoclavable (121°C).

The clear plastic is more

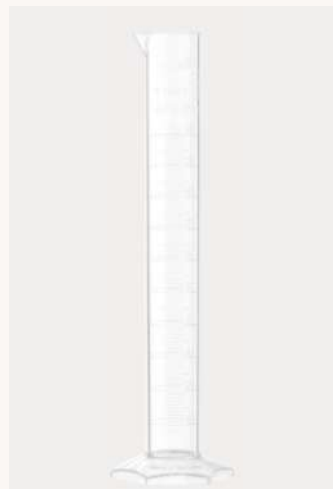

Item: 011850

Graduated cylinder, plastic, 10

Measuring glass in crystal clear PMP plastic. Tall shape. hexagonal base. autoclavable (121°C).

The clear plastic is more



Item: 011860

Graduated cylinder, plastic, 25

Measuring glass in crystal clear PMP plastic. Tall shape. hexagonal base. autoclavable (121°C).

The clear plastic is more



Item: 011880

Graduated cylinder, plastic, 10

Measuring glass in crystal clear PMP plastic. Tall shape. hexagonal base. autoclavable (121°C).

The clear plastic is more



Item: 012110

Mini Test Tube, Ø12 x 75 mm

Small test tubes with collar. DURAN.

DURAN glass is heat-resistant borosilicate glass that is highly tolerant to



Item: 012120

Test Tube, DURAN, Ø16 x 160

Top quality test tubes from DURAN.

DURAN glass is heat-resistant borosilicate glass that is highly tolerant to



Item: 012130

Test Tube, Ø18 x 180 mm

Standard size test tubes from DURAN.

DURAN glass is heat-resistant borosilicate glass that is highly tolerant to



Item: 012140

Test Tube, Ø25 x 200 mm

Test tube/jumbo test tubes from DURAN.

DURAN glass is heat-resistant borosilicate glass that is highly tolerant to



Item: 012150

Test Tube, DURAN, Ø30 x 200

Test tubes/jumbo test tubes from DURAN.

DURAN glass is heat-resistant borosilicate glass that is highly tolerant to



Item: 012330

Test Tube without Lip, Ø8 x 18

Test tube made of heat-resistant glass. Thickness 0.9mm.

Without any logo or division. Outer Diameter: 18 mm



Item: 012510

Test Tube, Ø12 x 75 mm, with R

Test tubes with collar. The test tubes are characterized by high glass quality and attractive design. All Borosil test tubes are made of heat-resistant 3.3 borosilicate



Item: 012520

Test Tube, Ø15 x 150 mm, with

Test tubes with collar. The test tubes are characterized by high glass quality and attractive design. All Borosil test tubes are made of heat-resistant 3.3 borosilicate



Item: 012530

Test Tube, Ø18 x 150 mm, with

Test tubes in standard size with collar. The test tubes are characterized by high glass quality and attractive design. All Borosil test tubes are made of heat-resistant 3.3



Item: 012540

Test Tube, Ø25 x 200 mm, with

Jumbo test tubes with collar. The test tubes are characterized by high glass quality and attractive design. All Borosil test tubes are made of heat-resistant 3.3



Item: 012550

Test Tube, Ø32 x 200 mm, with

Jumbo test tubes with collar. The test tubes are characterized by high glass quality and attractive design. All Borosil test tubes are made of heat-resistant 3.3



Item: 013404

Micropipette, Economy, 2 - 20

Good pipette in reasonable quality. Caps in different colors are included, so the color of the top can be varied according to the user's wishes. Tools and grease are



Item: 013406

Micropipette, Economy, 20 - 2

Good pipette in reasonable quality. Caps in different colors are included, so the color of the top can be varied according to the user's wishes. Tools and grease are



Item: 013408

Micropipette, Economy, 100 - 1

Good pipette in reasonable quality. Caps in different colors are included, so the color of the top can be varied according to the user's wishes. Also included are



Item: 013409

Micropipette, Economy, 1-5 mL

Good pipette in reasonable quality. Caps in different colors are included, so the color of the top can be varied according to the user's wishes. Also included are



Item: 013419

Pipette tips, 5 mL, for 013409

Specifically fits item no. 013409 Micropipette Economy 1-5 mL.
Brand: Sartorius Qty: 100 pcs.



Item: 013520

Volumetric pipette, 2 mL

Full pipette - Class B. Provided with a ring mark and color code.
Content: 2 mL Tolerance: 0.015 mL



Item: 013530

Volumetric pipette, 5 mL

Full pipette - Class B. Provided with a ring mark and color code.
Content: 5 mL Tolerance: 0.020 mL



Item: 013540

Volumetric pipette 10 mL

Full pipette - Class B. Provided with a ring mark and color code.
Content: 10 mL Tolerance: 0.030 mL



Item: 013550

Volumetric pipette, 20 mL

Full pipette - Class B. Provided with a ring mark and color code.
Content: 20 mL Tolerance: 0.045 mL



Item: 013560

Volumetric pipette 25 mL

Full pipette - Class B. Provided with a ring mark and color code.
Content: 25 mL Tolerance: 0.045 mL



Item: 013570

Volumetric pipette, 50 mL

Full pipette - class B. Provided with a ring mark and color code.
Content: 50 mL Tolerance: 0.075 mL Length: approx.



Item: 014010

Graduated pipette, 1 mL, class

Measuring pipette with graduation and color code. Complete outlet. Class B
Content: 1 mL Tolerance: 0.01 mL



Item: 076605

Carbon filters for 076600, 12 p

Active carbon filters for the 076600 distiller. Removes impurities from the water.



Item: 189610

Gastec rubber caps, 8 pcs.

Extra safety rubber caps for Gastec test tubes.



Item: 189600

Gas detector pump, Gastec

The Gastec gas tracker system is an absolutely suitable system for educational use. The system is easy to use, which makes it possible for most people to



Item: 014020

Graduated pipette, 2 mL, class

Measuring pipette with graduation and color code. Complete outlet. Class B
Content: 2 mL Tolerance: 0.02 mL



Item: 014030

Graduated pipette, 5 mL, class

Measuring pipette with graduation and color code. Complete outlet. Class B
Content: 5 mL Tolerance: 0.05 mL



Item: 014040

Graduated pipette, 10 mL, clas

Measuring pipette with graduation and color code. Complete outlet. Class B
Content: 10 mL Tolerance: 0.10 mL



Item: 014050

Graduated pipette, 25 mL, clas

Measuring pipette with graduation and color code. Complete outlet. Class B
Content: 25 mL Tolerance: 0.10 mL



Item: 014080

Graduated pipette, plastic, 1 m

Sarstedt transfer pipette made of polyethylene (PE) to avoid damage and infection from broken glass. The polyethylene is free of



Item: 014402

Micropipette Capp, 0.5-10 µl

Quality pipette from Danish Capp. Highly sensitive pipette with a range of 0.5-10 microliters.

This new Bravo model



Item: 014406

Micropipette Capp, 20-200 µl

Quality pipette from Danish CAPP. Variable volume 20-200 µL.

This new Bravo model replaces the well-known



Item: 014407

Micropipette Capp, 10-100 µl

Quality pipette from Danish CAPP. Variable volume 10-100 µL.

This new Bravo model replaces the well-known



Item: 014408

Micropipette Capp, 100-1000

Quality pipette from Danish CAPP. Variable volume 100-1000 L.

This new Bravo model replaces the well-known



Item: 014409

Micropipette Capp, 1-5 mL

Quality pipette from Danish CAPP. Variable volume 1-5 mL.

This new Bravo model replaces the well-known



Item: 014422

Capp sloping stand for 5 micr

Slanted stand with space for 5 micropipettes. The pipettes hang firmly in the holders and are easy to access. Most pipette brands fit in this practical and affordable



Item: 014430

Pipette tips, 10 µL, clear, 10 x 9

Autoclavable pipette tips in autoclavable boxes that can be refilled with 014435 Pipette Tips 10 µL, clear, refill or 014430RL Reload.



Item: 014430RL

Pipette tips, 10 µL, reload, 10 x

Smart and time-saving reload system for CAPP pipette tips. Easy and quick refilling of the boxes as the tips are already placed in a frame that fits in the boxes from item no.



Item: 014431

Pipette tips, 200 µL, clear, 10 x

Autoclavable pipette tips in autoclavable boxes that can be refilled with 014436 Pipette Tips 200L, yellow, refill or 014431RL Reload.



Item: 014431RL

Pipette tips, 200 µL, reload, 10

Smart and time-saving reload system for CAPP pipette tips. Easy and quick refilling of the boxes as the tips are already placed in a frame that fits in the boxes from item no.



Item: 014432

Pipette tips, 1000 µL, clear, 8 x

Autoclavable pipette tips 1000L, in autoclavable boxes, 8 boxes of 96 tips. Refillable with tips 014432RL reload system or 014439 (bag)



Item: 014432RL

Pipette tips, 1000 µL, reload, 5

Smart and time-saving reload system for CAPP pipette tips. Easy and quick refilling of the boxes as the tips are already placed in a frame that fits in the boxes from item no.



Item: 014435

Pipette tips, 10 µL, clear, refill

High quality autoclavable 10 µL pipette tips from Danish CAPP. Can be used for refilling in the autoclavable boxes 014430.



Item: 014436

Pipette tips, 200 µL, yellow, re

High quality, autoclavable 200 µL pipette tips from Danish CAPP. Can be used for refilling in the autoclavable boxes 014431.



Item: 014437

Pipette tips, 1000 µL, blue

Autoclavable 1000 µL pipette tips in high quality from Danish CAPP. Can NO longer be used for refilling in the autoclavable boxes 014432. Use 014439



Item: 014439

Pipette tips, 1000 µL, clear, refi

1000 µL pipette tip that can be used in the boxes of 014432 Pipette Tips 1000 µL. **Pack of 500** Type. CAPP Expel Plus



Item: 014440

Pipette tips, 5000 µL, Capp

Autoclavable 5000 µL pipette tips. Suitable for Capp pipettes 1-5 ml. Compatible with most common pipette brands



Item: 014460

Pipette tips, 200 µL, with filter,

Autoclavable 200 µL pipette tips in hinged boxes that can be refilled and autoclaved. Very useful for PCR as the use of filter tips significantly reduces the risk of sample



Item: 014462

Pipette tips, 1000 µL, with filter

Autoclavable 1000 microliter pipette tips in hinged boxes that can be refilled and autoclaved. Very useful in PCR as the



Item: 014490

Dropper pipette, plastic, 1 mL,

These handy disposable plastic pipettes make it easy and safe for your students to measure and transfer small amounts of liquid. With built-in suction ball and clear



Item: 014500

Transfer pipet, PP, graduated,

These handy disposable plastic pipettes make it easy and safe for your students to measure and transfer small amounts of liquid. With built-in suction ball and clear



Item: 014506

Dropper pipette, plastic, 6 mL,

These handy disposable plastic pipettes make it easy and safe for your students to measure and transfer small amounts of liquid. With built-in suction ball and clear



Item: 014510

Dropper pipette, plastic, 3 mL,

These handy disposable plastic pipettes make it easy and safe for your students to measure and transfer small amounts of liquid. With built-in suction ball and clear



Item: 014520

Dropping Pipette, Glass, with

Glass dropper pipette with rubber suction ball. Functional for mixing small amounts of chemicals, adding nutrient salts or fruit coloring for baking cakes. The rubber



Item: 014525

Bulbs for dropper pipette

Rubber suction ball for dropper and pasteurizer pipettes. When the rubber cap on the dropper becomes slightly brittle or cracks, it can be replaced with a new one.



Item: 014610

Pasteur pipette, Glass

Pasteur pipette in glass. Classic laboratory pipette for small drops. Good for transferring bacteria for seeding, staining or similar.



Item: 014710

Burette with spigot end, 0.1 - 2

Burette with spigot instead of tap
Content: 25 mL Division: 1/10 mL Length: 71 cm
This [burette without tap, 25](#)



Item: 014810

Burette, Glass Stopcock, 0.1 -

Burette with glass tap. Standard glass quality.
Content: 25 mL Division: 1/10 mL Length: 50 cm.



Item: 014820

Burette, Glass Stopcock, 0.1 -

Burette with glass tap. Standard glass quality
Content: 50 ml Division: 1/10 ml Length: 80 cm



Item: 868510-4

Sodium hydroxide, 0.1 M, 1 L

Natron lye 0.1M - aqueous solution. Formula: NaOH
Molecular weight: 40.00 CAS: 1310-73-2



Item: 868610-4

Sodium hydroxide, 1 M, 1 L

About 3.8% NaOH - aqueous solution
Molecular weight: 40.00 CAS: 1310-73-2



Item: 868620-4

Sodium hydroxide, 2 M, 1 L

About 7.4% NaOH - aqueous solution
Molecular weight: 40.00 CAS: 1310-73-2



Item: 868620-6

Sodium hydroxide, 2 M, 5 L

About 7.4% NaOH - aqueous solution Molecular weight: 40.00 CAS: 1310-73-2



Item: 869100-2

Sodium nitrate, technical, 250

Synonym: Chile salt peter
Formula: NaNO_3 Molecular weight: 84.99 Purity: Technically pure CAS: 7631-99-4



Item: 869700-4

tri-Natriumphosphat, ren

Formula: $\text{Na}_3\text{PO}_4 - 12\text{H}_2\text{O}$
Molecular weight: 380.12
Purity: Pure CAS: 10101-89-0



Item: 870300-3

Natriumsulfat, vandfrit

Sodium sulfate - anhydrous
Formula: Na_2SO_4 Molecular weight: 142.04 Purity: 99/100% CAS: 7727-73-3



Item: 872800-8

Nitratreagens i dråbeflaske

0.1% solution in 4M acetic acid
Synonym: Nitrate Reagent. Formula: $\text{C}_{20}\text{H}_{16}\text{N}_4$ CAS: 552-89-6



Item: 874700-4

Oxalsyre, teknisk

Synonym: Ethanedioic Acid
Formula: $(\text{COOH})_2 - 2\text{H}_2\text{O}$
Molecular Weight: 126.07
Purity: Technically Pure CAS: 144-62-7G



Item: 876400-2

Paraffin, beads, 250 g

Melting point: 52-54°C Purity: Pure



Item: 876400-4

Paraffin, beads, 1kg

Melting point: 52-54°C Purity: Pure



Item: 000100

Retort stand base, A-shaped,

A base with 10 mm hole and clamping screw. Painted cast iron with rubber feet.
Side length: 20 cm.
Weight: 2.0 kg



Item: 000130

Support base, 2.3 kg

Classic A-foot for laboratory setups. Fits standard 10-12 mm tripod poles.
The finish is slightly rougher than on our high-end tripod



Item: 876500-4

Paraffinolie

Synonym: Vaseline oil Purity: Pure (Ph.Eur.) CAS: 8042-47-5



Item: 877208

Pentan, 99 %, ren

Formula: $\text{CH}_3(\text{CH}_2)_3\text{CH}_3$
Molecular weight: 72.15
Purity: Pure CAS: 109-66-0



Item: 877500-1

Peptone, pure

Nutrient substrate



Item: 877800

Petroleum, lugtfri

Fl flash point: 65 °C Purity: Technically pure CAS: 64771-72-8



Item: 879200-4

Pimpsten, kogesten

Pumice stones



Item: 880474

Buffer, capsule, pH 4

Potassium hydrogen phthalate buffer, capsule pH 4.
Open the capsule and shake out the contents into 100 mL



Item: 880477

Buffer, capsule, pH 7

Sodium phosphate / Potassium dihydrogen phosphate buffer. Capsule pH 7
Open capsule and shake out



Item: 880479

Buffer, capsule, pH 9

Sodium hydrogen carbonate / sodium carbonate buffer. Capsule pH 9
Open capsule and shake contents into 100 mL



Item: 880541

Buffer, pH 4,00, red

Finished buffer solution ready to use. The buffer is color-coded and has a minimum shelf life of 6 months. To ensure the longest possible shelf life, it is a good idea to



Item: 880571

Buffer, pH 7,00, green

Finished buffer solution ready to use. The buffer is color-coded and has a minimum shelf life of 6 months. To ensure the longest possible shelf life, it is a good idea to



Item: 041550

Folded filters, Ø150 mm

Macherey Nagel MN616 medium speed pleated filter.

- Diameter: 150 mm
- Density: Approx. 12 µm



Item: 041590

Filter paper, sheet 45 x 45 cm

Filter paper in square sheets, MN 612. For general filtration. Dimensions: 450 x 450 mm Thickness: 0.2 mm Weight: 75 g/m²



Item: 041610

Extraction thimbles, 100 x Ø23

Extraction sleeves for Soxhlet extraction Macherey Nagel MN645. The sleeves are made of pure cellulose.



Item: 041715

Filter, Qualitative, Ø90 mm

Good quality round filters, medium to fast filtration, medium density. Diameter: 90 mm.



Item: 041725

Filter, Qualitative, Ø110 mm

Good quality round filters, medium to fast filtration, medium density.
Diameter: 110 mm.



Item: 041730

Filter, Qualitative, Ø125 mm

Good quality round filters, medium to fast filtration, medium density.
Diameter: 125 mm.



Item: 041740

Filter, Qualitative, Ø150 mm

Good quality round filters, medium to fast filtration, medium density.
Diameter: 150 mm.



Item: 042010

Chromatography paper, 4 x 14

Chromatography paper for paper chromatography. The paper is porous, so runners can penetrate far up the paper and pull pigment



Item: 042200

Parafilm, 5 cm x 75 m

Parafilm. Flexible, semi-transparent protective film that can be stretched up to 200%. Self-adhesive and resistant to most chemicals. Used to cover e.g. beakers



Item: 042220

Parafilm, 10 cm x 38 m

Parafilm. Flexible, semi-transparent protective film that can be stretched up to 200%. Self-adhesive and resistant to most chemicals. Used to cover e.g. cups and



Item: 042300

High vacuum grease 35g

High Vacuum Grease for use when joining cut glass. High Vacuum Grease ensures that the joint is completely sealed to avoid



Item: 042510

Rubber stopper, 8/12 mm, with

Tapered rubber plugs without holes made of red natural rubber. Can be used at temperatures from -30 to 60 °C



Item: 043010

Stopper, Ø14/18 mm, no hole

Tapered rubber plugs without holes made of red natural rubber. Can be used at temperatures from -30 to 60 °C



Item: 043020

Stopper, Ø14/19 mm, 1 hole

Conical rubber plugs with 1 hole made of red natural rubber. Can be used at temperatures from -30 to 60 °C



Item: 043030

Stopper, Ø14/19 mm, 2 holes

Tapered rubber stopper with 2 holes made of red natural rubber. Can be used at temperatures from -30 to 60 °C



Item: 043510

Rubber stopper, 17x22 x 25 m

Tapered rubber plugs without holes made of red natural rubber. Can be used at temperatures from -30 to 60 °C



Item: 043520

Rubber bung, 17/22, 1 hole

Conical rubber plugs with 1 hole made of red natural rubber. Can be used at temperatures from -30 to 60 °C



Item: 043710

Stopper, Ø20/25 mm, no hole

Tapered rubber plugs without holes made of red natural rubber. Can be used at temperatures from -30 to 60 °C



Item: 043720

Stopper, Ø20/25 mm, 1 hole

Conical rubber plugs with 1 hole made of red natural rubber. Can be used at temperatures from -30 to 60 °C



Item: 043730

Stopper, Ø20/25 mm, 2 holes

Tapered rubber stopper with 2 holes made of red natural rubber. Can be used at temperatures from -30 to 60 °C



Item: 044510

Rubber stopper, 26x 32 x 30

Tapered rubber plugs without holes made of red natural rubber. Can be used at temperatures from -30 to 60 °C



Item: 044520

Rubber stopper, 25/32, 1 hole

Conical rubber plugs with 1 hole made of red natural rubber. Can be used at temperatures from -30 to 60 °C



Item: 044530

Rubber bung, 25/32, 2 holes

Tapered rubber plugs with 2 holes made of red natural rubber. Can be used at temperatures from -30 to 60 °C



Item: 045010

Stopper, Ø29/35 x 30 mm, no

Tapered rubber plugs without holes made of red natural rubber. Can be used at temperatures from -30 to 60 °C



Item: 045020

Stopper, Ø30/35 mm, 1 hole

Conical rubber plugs with 1 hole made of red natural rubber. Can be used at temperatures from -30 to 60 °C



Item: 045030

Stopper, Ø30/35 mm, 2 holes

Tapered rubber plugs with 2 holes made of red natural rubber. Can be used at temperatures from -30 to 60 °C



Item: 045510

Rubber stopper, 35/45 x 35 m

Tapered rubber plugs without holes made of red natural rubber. Can be used at temperatures from -30 to 60 °C



Item: 045520

Rubber stopper, 35/45 x 35 m

Conical rubber plugs with 1 hole made of red natural rubber. Can be used at temperatures from -30 to 60 °C



Item: 045530

Rubber stopper, 35/45 x 35 mm

Tapered rubber plugs with 2 holes made of red natural rubber. Can be used at temperatures from -30 to 60°C



Item: 046010

Rubber stopper, 46/55 mm

Tapered rubber plugs without holes made of red natural rubber. Can be used at temperatures from -30 to 60°C



Item: 046020

Rubber stopper, 46/55 mm, 1

Conical rubber plugs with 1 hole made of red natural rubber. Can be used at temperatures from -30 to 60°C



Item: 046030

Rubber stopper, 46/55 mm, 2

Tapered rubber plugs with 2 holes made of red natural rubber. Can be used at temperatures from -30 to 60°C



Item: 047000

Rubber stopper assortment

Rubber plug assortment consisting of 48 rubber plugs. Different dimensions, with and without holes.



Item: 047110

Stopper, PE, with NS 14/23

Stopper with normal grinding for standpipes and volumetric flasks. Made of polyethylene. NS grind: 14/23 mm
Fitting flasks:



Item: 047120

Stopper, PE, with NS 19/26

Stopper with normal grinding for standpipes and volumetric flasks. Made of polyethylene. NS grind: 19/26 mm
Fitting flasks:



Item: 035000

Crucible Tongs

Dig pliers in stainless steel (18/8). Double bent. Total length: 200 mm



Item: 035010

Glass beaker tongs

Cup tongs with plastic-coated handle. Ideal for moving hot beakers.
Length approx. 25 cm and max grip approx. 20 cm.

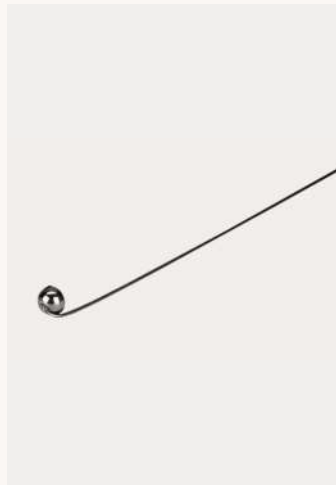

Item: 036010

Spoon

Incineration spoon made of stainless steel.
Diameter (spoon): 21 mm
Total length: 450 mm
Depth: 12 mm



Item: 036500

Iron crucible with lid, Ø50 mm

Stainless steel crucible with lid.
Diameter: 50 mm
Height: 35 mm



Item: 037000

Crucible with wooden handle

Melting crucible. Made of iron and with wooden handle.
Total length: 280 mm
D crucible diameter: 75 mm



Item: 037505

Rubber tubing, red, Ø4/6 mm

Red rubber hose. Length: 5 m.
Inner/outer diameter: 4/6 mm



Item: 037510

Rubber tubing, red, Ø6/9 mm

Red rubber hose. Length: 5m.
Inner/outer diameter: 6/9 mm



Item: 037515

Rubber tubing, red, Ø9/13 mm

Red rubber hose. Length: 5m.
Inner/outer diameter: 9/13 mm



Item: 037520

Gas tubing, Ø8/15 mm (EN-16)

Gas hose approved for use with LPG, natural gas and city gas. Complies with European standard EN-16436-1 (*).
Inner/outer diameter: 8/15



Item: 037540

Vacuum hose

Blød Vacuum hose. Fits the water air pumps, vacuum pump and air pump plate.
Dimension Ø: 8/18 mm



Item: 041310

Micropipette 2 – 20 µL Edvoté

Variable micropipettes are robustly designed and available with different volumes in the range 2 - 20 microliters and use standard pipette tips. Volume is easily



Item: 041320

Micropipette 20 – 200 µL Edv

Variable micropipettes are robustly designed and available with different volumes in the range 20 - 200 microliters and use standard pipette tips. Volume is easily



Item: 041330

Micropipette 100 – 1000 µL Ed

Variable micropipettes are robustly designed and available with different volumes in the range 100 - 1000 microliters and use standard pipette tips. Volume



Item: 866500-5

Sodium carbonate, soda anhy

Calcined soda ash - anhydrous. Formula: Na_2CO_3 .
Molecular weight: 105.99.
Purity: Pure 98-100%. CAS: 497-19-8.



Item: 590500

Emery Cloth, P 120

8 mm wide, 5 pieces of 20 cm.



Item: 591300

Marking tape, 13 mm, white

White marking tape, 13 mm wide, for color marking of e.g. test tubes and bottles. The matte surface makes the tape suitable for writing on (pen, pencil, marker)



Item: 591500

Etiketter, grundsæt

Labels basic set for waste cart 901350.



Item: 591600

Tape, black

PVC, 15 mm x 10 m



Item: 053510

Plastic canister, 5 L, with stop

Heavy-walled and very robust HDPE canister in semi-transparent plastic, with tight-fitting drain cock, carrying handle and black screw cap equipped with a special



Item: 053520

Plastic canister, 10 L, with stop

Heavy-walled and very robust HDPE canister in semi-transparent plastic, with tight-fitting drain cock, carrying handle and black screw cap equipped with a special



Item: 053530

Plastic canister, 25 L, with stop

Heavy-walled and very robust HDPE canister in semi-transparent plastic, with tight-fitting drain cock, carrying handle and black screw cap equipped with a special



Item: 053740

Plastic Can, 1 L

Disposable canister with handle in whitish, flexible plastic. Good for storing various chemicals or demineralized water.



Item: 053750

Plastic Can, 2.5 L, UN approve

Plastic canister (disposable) with handle. Inner neck with diameter of 34 mm.
Volume: 2.5 L
The canister is UN approved.



Item: 053820

Plastic Bottle, 500 mL, UN Ap

Round plastic bottle (disposable) for chemical storage
Volume: 500 ml neck diameter 28 mm



Item: 053840

Plastic Can, 1 L, UN Approved

Round plastic bottle in HDPE (disposable) for chemical storage.
Volume: 1L. neck diameter 28 mm.



Item: 053845

Plastic bottle with cap, 1 L, app

Square heavy-duty HDPE plastic bottle from Kautex for chemical storage

Volume: 1L

The canister is UN approved



Item: 053900

Waste Can, 25 L

UN approved plastic waste bin. Suitable for collecting chemical waste.

Specifications:

- Volume: 25 L



Item: 053905

Cap for 053900, Waste Contai

This lid fits both 10 liter and 25 liter canisters, ensuring a tight seal and protecting contents from spills and contamination. It is ideal for storing and handling liquids in



Item: 054010

Lab Bottle, 100 mL, PP

Lab bottle with NS plastic stopper. Natural colored polypropylene.

Volume: 100 mL NS: 14/23 Ø: 53 mm



Item: 054020

Lab Bottle, 250 mL, PP

Lab bottle with NS plastic stopper. Natural colored polypropylene.

Volume: 250 mL NS: 19/26 Ø: 70 mm



Item: 054030

Lab Bottle, 500 mL, PP

Lab bottle with NS plastic stopper. Natural colored polypropylene.

Volume: 500 mL NS: 24/29 Ø: 87 mm



Item: 054040

Lab Bottle, 1000 mL, PP

Lab bottle with NS plastic stopper. Natural colored polypropylene.

Volume: 1000 mL NS: 29/32 Ø 98 mm



Item: 054520

Lab Bottle, 250 mL, NS Stoppe

Clear glass lab bottle with polyethylene stopper with normal grind

Volume: 250 mL NS: 19/26 Ø: 70 mm



Item: 054530

Lab Bottle, 500 mL, NS Stoppe

Clear glass lab bottle with polyethylene stopper with normal grind

Volume: 500 mL NS: 24/29 Ø: 87 mm



Item: 054820

Lab Bottle, 250 mL, GL45 Cap,

Lab bottle with blue ISO screw cap and pouring ring from Borosil. Heat-resistant borosilicate glass 3.3.

Volume: 250 mL Lid: GL 45



Item: 054830

Lab Bottle, 500 mL, GL45 Cap,

Lab bottle with blue ISO screw cap and pouring ring from Borosil. Heat-resistant borosilicate glass 3.3.

Volume: 500 mL Lid: GL 45



Item: 054840

Lab Bottle, 1000 mL, GL45 Cap

Lab bottle with blue ISO screw cap and pouring ring from Borosil. Heat-resistant borosilicate glass 3.3.

Volume: 1000 mL Lid: GL 45



Item: 055000

Lab Bottle, 50 mL, GL32 Cap,

Lab bottle with ISO screw cap. Made of clear DURAN borosilicate glass with graduation on the side.

Equipped with drip edge and screw cap with ISO



Item: 055005

Lab Bottle, 25 mL, GL25 Cap,

Lab bottle with ISO screw cap. Made of clear DURAN borosilicate glass with graduation on the side.

Equipped with drip edge and screw cap with ISO



Item: 055010

Lab Bottle, 100 mL, GL45 Cap,

Lab bottle with ISO screw cap. Made of clear DURAN borosilicate glass with graduation on the side.

Equipped with drip edge and screw cap with ISO



Item: 055020

Lab Bottle, 250 mL, GL45 Cap,

Lab bottle with ISO screw cap. Made of clear DURAN borosilicate glass with graduation on the side.

Equipped with drip edge and screw cap with ISO



Item: 055040

Lab Bottle, 1000 mL, GL45 Cap

Lab bottle with ISO screw cap. Made of clear DURAN borosilicate glass with graduation on the side. Equipped with drip edge and screw cap with ISO



Item: 055050

Lab Bottle, 2000 mL, GL45 Ca

Lab bottle with ISO screw cap. Made of clear DURAN borosilicate glass with graduation on the side. Equipped with drip edge and screw cap with ISO



Item: 055193

Membrane cap for Blue Cap G

Screw cap for standard Bluecap bottles (GL45). The cap has a PTFE membrane that is gas permeable, which together with the rest of the cap's usual Duran quality



Item: 055230

DURAN, Bluecap, Square, 500

New square model that takes up less space in the cabinet or autoclave. Comes with blue lid and tilt ring, as well as 8-digit "Retrace Code" for full



Item: 055330

Lab Bottle, 500 mL, GLS80, WI

Suitable for e.g. heating/melting agar in the microwave. The bottle has a larger diameter than the well-known Blue Cap bottles (e.g. 055030) and the height is



Item: 055510

Reagent bottle, 30 mL, amber

Brown glass bottle with narrow neck and black screw cap with standard thread. Also referred to as "Medicine bottle".



Item: 055520

Reagent bottle, 60 mL, amber

Brown glass bottle with narrow neck and black screw cap with standard thread. Also referred to as "Medicine bottle".



Item: 055530

Reagent bottle, 100 mL, amber

Brown glass bottle with narrow neck and black screw cap with standard thread. Also referred to as "Medicine bottle".



Item: 055540

Reagent bottle, 200 mL, ambe

Brown glass bottle with narrow neck and black screw cap with standard thread. Also referred to as "Medicine bottle".



Item: 052600

Spray bottle

0.5L white plastic water atomizer with pump
Dimensions: 90x90x250 mm.



Item: 052915

Plastic beaker with grip lid, 36

Clear plastic cup with lid
Volume: 365 mL Diameter: 95 mm Height: 79 mm



Item: 053005

Plastic box, clear, rectangular,

Square can in PVC. Transparent with black screw cap.
Volume: 50 ml Height: 60 mm Width: 30 mm Wall: 23 mm



Item: 593700

Marker pen for glass

Permanent OHP that writes on almost any surface and can be left uncapped for up to 3 days. Ergonomic grip zone and practical clip.



Item: 053006

Plastic box, clear, rectangular,

Square can in PVC. Transparent with black screw cap.
Volume: 100 ml Height: 72 mm Width: 46 mm Width: 31



Item: 053007

Plastic box, clear, rectangular,

Square can in PVC. Transparent with black screw cap.
Volume: 300 ml Height: 95 mm Width: 66 mm Wall: 41



Item: 053008

Plastic Box, Clear, Rectangular,

Square can in PVC. Transparent with black screw cap.
Volume: 500 ml Height: 108 mm Width: 80 mm Width: 54



Item: 053009

Plastic Box, Clear, Rectangular,

Square can in PVC. Transparent with black screw cap.
Volume: 1000 ml Height: 147 mm Width: 95 mm Width: 69



Item: 053010

Plastic Box, Square, 100 mL

Square can with wide neck and screw cap. Made in natural colored HDPE. Black PP screw cap with PE foam insert.



Item: 053020

Plastic Box, Square, 250 mL

Square can with wide neck and screw cap. Made of natural colored HDPE. Black PP screw cap with PE foam insert.



Item: 541240

pH meter, M350, pH/mV

Handheld battery-powered pH/mV meter with digital scale. The instrument is very easy to operate and provides fast and reliable measurements with



Item: 510000

Risøkilder, complete set, UN29

Note: Currently, you should expect long delivery times and significant price increases on the listed price, as our supplier is raising their prices



Item: 510505

Radioactive Americium source

Approved radioactive alpha source for use with fog chamber. Fitted with black plastic shaft and thread for clamping in fog chamber.



Item: 053030

Plastic Box, Square, 500 mL

Square can with wide neck and screw cap. Made of natural colored HDPE. Black PP screw cap with PE foam insert.



Item: 053100

Plastic Flask, 50 mL

Kautex plastic bottle type 303. Round model with wide neck and tight-fitting lid. Very robust type made of semi-transparent LDPE plastic. Particularly suitable for



Item: 053105

Plastic Flask, 100 mL

Kautex plastic bottle type 303. Round model with wide neck and tight-fitting lid. Very robust type made of semi-transparent LDPE plastic. Particularly suitable for



Item: 053110

Plastic Flask with Lid, 250 mL

Kautex plastic bottle type 303. Round model with wide neck and tight-fitting lid. Very robust type made of semi-transparent LDPE plastic. Particularly suitable for



Item: 053120

Plastic Flask with Lid, 500 mL

Kautex plastic bottle type 303. Round model with wide neck and tight-fitting lid. Very robust type made of semi-transparent LDPE plastic. Particularly suitable for



Item: 053130

Plastic Flask with Lid, 1000 mL

Kautex plastic bottle type 303. Round model with wide neck and tight-fitting lid. Very robust type made of semi-transparent LDPE plastic. Particularly suitable for



Item: 053210

Tub with Screw Top, Clear, 100

Can in clear PET with white screw cap
Volume: 100 mL Diameter: 74 mm Width 60 mm Height 37 mm



Item: 053215

Tub with Screw Top, Clear Plas

Clear plastic can with white screw cap
Volume: 50 mL



Item: 053225

Tub with screw top, clear, 20

Tub with screw top in transparent heavy polystyrene with white lid.

- Volume: 20 ml
- Diameter: 37 mm



Item: 053230

Lipstick sleeve, PP, Ø11 x 68 m

Sleeve with screw feed for lip balm. Made of polypropylene. Dimensions: 11 x 68 mm



Item: 053244

Collection jar ,100 mL

Round clear plastic collection jars with screw cap
Volume: 100 ml Height: 83 mm Ø: 47 mm Width: 35 mm



Item: 053245

Collection tub, 280 mL

Round clear plastic collection jars with clamp lid (honey glass type).
Volume: 280 ml Height: 62 mm Ø: 95 mm Width: 85 mm



Item: 053246

Collection tub, 520 mL

Round clear plastic collection jars with clamp lid (honey jar type).
Volume: 520 ml Height: 114 mm Ø: 95 mm Width: 85 mm



Item: 053247

Collection tub, 1180 mL

Round clear plastic collection jars with clamp lid (honey jar type).
Volume: 1180 ml Height: 131 mm Ø: 133 mm Width: 120



Item: 053250

Mini Tubs with Lids

Clear plastic. Volume: 30 ml.



Item: 053340

Plast container, 1 L

PP plastic bucket with lid
Volume: 1 L Outer upper diameter: Approx. 13 cm Height: Approx. 12 cm Piff finger protection: Yes



Item: 053350

Bucket with lid, 3 L

Bucket with lid. Made of plastic
Diameter: 195 mm Volume: 3 L



Item: 053360

Bucket with lid, 6 L

Bucket with lid. Made of plastic
Diameter: 222 mm Volume: 6 L



Item: 053370

Plastic bucket, with lid, 11.1 L

Bucket with lid. Made of plastic.
Volume: 11.1 L

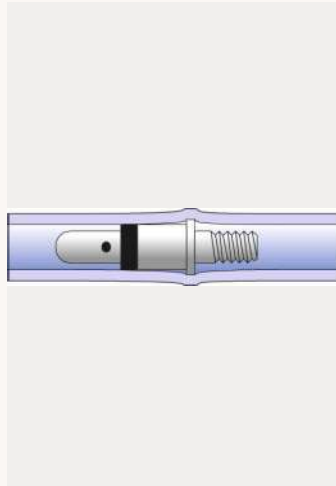

Item: 594810

Cycle valve, ball

Supplied without hose.



Item: 541520

pH electrode, BNC Connector

pH electrode Standard pH combination electrode. Plastic rod with gel electrolyte.
Ø 12 mm Length 85 mm BNC connector



Item: 541600

Storage set for pH electrodes

500 mL glass bottle with special screw cap with silicone gasket. The silicone gasket hole has a diameter that fits all standard pH electrodes and because it fits



Item: 053380

Bucket, 12 L

Plastic bucket in black LD-PE plastic
Volume: 12 L Diameter: 28 cm



Item: 590200

Cotton wool

Water on a 100 gram roll.



Item: 590400

Steel wool, fine

Fine steel wool for grinding, polishing or cleaning.



Item: 591200

Self-Adhesive Tape

Standard transparent roll tape or self-adhesive tape with a width of 15 mm.



Item: 595200

Dice

Common standard cubes that can be used for simulating radioactive decay, for statistics and probability calculations or just for fun.



Item: 576698

White shelf for system frame

White metal shelf for system shelving and system trolleys. Sold individually. Dimension Width: 335



Item: 576706

Gratnells storage frame, 3 col

System rack for stationary storage of trays. Supplied without trays, shelves and guide rails. The rack can be used in combination with all sizes of Gratnell



Item: 577000

Storage Crate with Lid, Small

Solid plastic (non-PVC) case with carrying handle and lid Suitable for storing and transporting educational materials



Item: 577010

Storage Crate with Lid, Large

Solid plastic (non-PVC) case with carrying handle and lid Suitable for storing and transporting educational materials



Item: 056610

Sample Holder with Snap Lid,

Small glasses with snap-on lids.



Item: 056620

Sample Holder with Snap Lid, 1

Small glasses with snap lid. Inner diameter of opening: 16.7 mm



Item: 056630

Sample Holder with Snap Lid,

Small glasses with snap-on lids.



Item: 056640

Sample Holder with Snap Lid,

Small glasses with snap-on lids.



Item: 056641

Lid for Sample Holders, 7 - 28

Lid for Sample Holders, 7 - 28 mL



Item: 056650

Sample Holder with Snap Lid,

Small glasses with snap-on lids.



Item: 057000

Wire basket for 8 dropper bott

Chemical wire basket in plastic-coated metal wire. Suitable for e.g. 056110 Bottle with pipette 30 mL (Ø32 mm).



Item: 057010

Carrying Rack, 54 x 54 mm

Chemical wire basket in plastic-coated metal wire with carrying handle. Can be used for e.g. 6 dropper or pipette bottles (not included).



Item: 057030

Wire basket with handle, open

Chemical wire basket in plastic-coated metal wire and carrying handle
Number of compartments: 2 x 3
Compartment diameter: 75

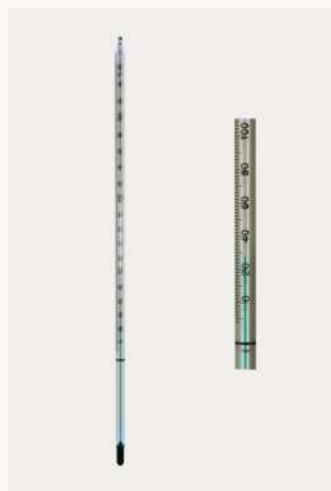

Item: 057520

Thermometer, -10 to +360 °C

Glass thermometer with eye for hanging, green filling on white background. Biodegradable alcohol filling. Temperature range: -10 - +

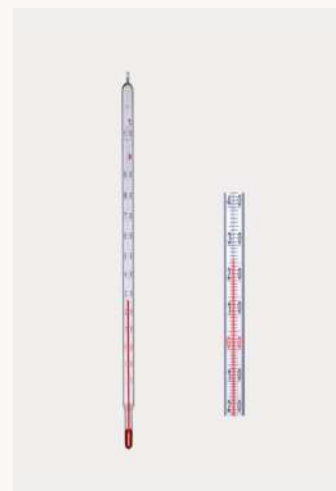

Item: 058210

Thermometer, -16 to +110 °C

Glass thermometer with red red filling on a milky white background. Biodegradable alcohol filling. Temperature range: -16 - +

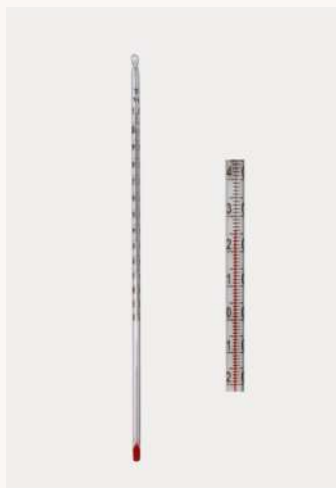

Item: 058225

Thermometer, -20 to +110 °C

Glass thermometer, red filling on a milky white scale
 Temperature range: -20 - +110 °C Resolution: 1/1
 Length: 300 mm Diameter: 6

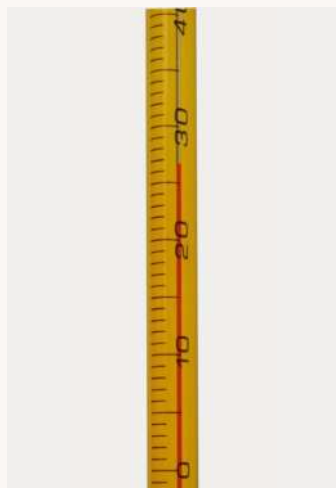

Item: 058500

Thermometer, -20 to +110 °C, Y

Prismatic, triangular, thermometer, red fill on yellow background
 Temperature range: -20 - +110 °C Resolution: 1/1



Item: 059010

Thermometer, -10 to +110 °C, n

Glass thermometer with blue filling.
 With this thermometer, students can, for example, be challenged to find ways to

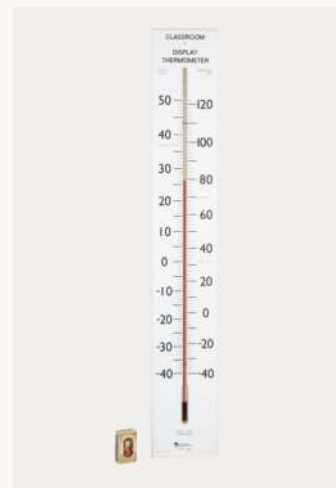

Item: 059100

Demonstration thermometer

Large, easy-to-read thermometer for classroom teaching and demonstrations. With a height of 75 cm, this thermometer is perfect for educational use as it is easy



Item: 060010

Thermometer on plastic back

Good thermometer for educational use. The glass thermometer is protected in the plastic plate to minimize the risk of damage to the



Item: 064066

Magnetic Stirrer, Green

Compact lightweight magnetic stirrer from Hanna Instruments. Stirring capacity of 1L with stepless speed adjustment.



Item: 064067

Magnetic Stirrer, Blue

Compact lightweight magnetic stirrer from Hanna Instruments. Stirring capacity of 1L with stepless speed adjustment.



Item: 065503

Stir magnet, 8 x Ø3 mm

PTFE-coated stir magnet with a round, smooth surface. The small size (8 x 3 mm) makes it suitable for microscale chemistry and more. Very good chemical resistance and



Item: 052511

Squeeze Bottle, 250 mL

Spray bottle with soft plastic spout
Volume: 250 mL



Item: 052521

Squeeze Bottle, 500 mL

Spray bottle with soft plastic spout
Volume: 500 mL



Item: 052550

Squeeze Bottle, Acetone, 500

Soft plastic spray bottle with print: Acetone
The bottle has statutory hazard pictograms.
Volume: 500 ml.



Item: 052555

Squeeze Bottle, Ethanol, 500

Soft plastic spray bottle with print: "Ethanol".
The bottle has statutory hazard pictograms.
Volume: 500 ml.



Item: 052560

Squeeze Bottle, Demineralised

Soft plastic spray bottle with print: "Demineralized water"
Volume: 500 ml
OBS: supplied without contents



Item: 052910

Plastic beaker with grip lid, 15

Clear plastic cup with lid
Volume: 155 mL Diameter: 69 mm Height: 68 mm



Item: 449810

Plate electrode, zinc

These metal plates are designed for use in teaching experiments with electrolysis, galvanic elements and voltage series. With their convenient size and flat



Item: 260610

Digital thermometer, type 305

A handy and robust digital thermometer for type K sensors. Comes with blue rubber protective cap, tilt bracket and carrying handle. The device is equipped with a



Item: 260615

Digital thermometer, type 307

A handy and robust digital thermometer for type K thermosensors with two inputs. The device comes with a blue rubber protection cap, tilt bracket and carrying



Item: 260650

Liquid probe, Type K, 105 mm

Temperature sensor for liquids and other media like soil or insulation materials. The sensor is made of stainless steel,



Item: 260704

Thermometer, digital, mini, wit

The digital display is equipped with large, easy-to-read numbers, which make it easy to read the measurements quickly and accurately, even in



Item: 260710

Digital thermometer with lead,

Digital thermometer for field use and laboratory experiments - perfect for precise temperature measurements in the field, laboratory or other



Item: 576645

Insert with 3 compartments

Inserts for system tray. Made of gray plastic. Number of compartments : 3 Dimension : 80 x 340 mm. Depth: 40 mm



Item: 576646

Insert with 4 compartments

Gray plastic insert with 4 compartments of 120 x 160 mm. Height is 40 mm.

Made for Gratnell containers



Item: 576647

Insert with 6 compartments

Gray plastic insert with 6 compartments of 75 x 160 mm. Height is 40 mm.

Made for Gratnell containers



Item: 576648

Insert for 8 mounted units

Inserts for system tray. Made of gray plastic. Number of compartments : 8 Dimension : 75 x 120 mm. Depth: 40 mm



Item: 576650

Insert for 30 student coils

White plastic insert with 30 compartments for coils with an inner diameter of 2 cm

Made for Gratnell containers



Item: 576652

Insert with 6 dissimilar compa

Gray plastic insert with 6 compartments in different sizes. The height is 40 mm. Made for Gratnell containers with a height of 75 or 150 mm. Box



Item: 576656

Insert for 12 thermometers

Grey plastic insert with 12 rectangular, narrow compartments. Suitable for thermometers. Height is 40 mm.



Item: 576658

Insert for 24 magnets

Gray plastic insert for 12 U magnets and 12 sets of 2 bar magnets. Height is 40 mm.

Made for Gratnell containers



Item: 576663

Insert for 6 U/I cores

Grey plastic insert for six U and I cores with clamping screw (463000). Height is 40 mm.

Designed to fit Gratnells



Item: 576679

Insert, 30 compartments, size:

Foam insert with 30 punched holes (56 x 25 mm) for Gratnell trays. Suitable for e.g. safety glasses.



Item: 576680

Foam inserts, for Gratnell trays

Foam insert for Gratnells containers for 30 bottles or jars. Fits all Gratnells containers with a height of 75 or 150 mm. Hole diameter is 44



Item: 576682

Lid for Gratnell trays

Tight-fitting lid with snap lock for system tray. The lid is transparent and made of impact-resistant plastic material. Even though the tray has a lid, it fits into the



Item: 576695

Gratnells metal runners, white,

Gratnell guide rails for shelving and system trolleys. Used for mounting system trays. Sold in pairs. Color: White.



Item: 670145

Glass rod, stirrer 7 x 200 mm

Glass sticks. Can be used as a stirring stick or for grafting
Diameter: 7 mm Length: 200 mm



Item: 670159

Stand clamp, standard

Ordinary tripod clamp intended for clamping in sleeve and tripod arm
Length of arm: 260 mm
OBS: Color of protective



Item: 438010

Rubbing rod, glass

Glass rod for generating static electricity by rubbing
Dimension: Ø10 x 225 mm.



Item: 449710

Universal electrode holder, do

Electrode holder for two electrodes. Can be used for both round electrodes (4510XX) and plate-shaped ele



Item: 670160

Labvett-plakat

Poster, 64 cm x 46 cm.
General safety rules in the lab.
A useful and colorful poster for safety education.



Item: 055550

Reagent bottle, 500 mL, ambe

Brown glass bottle with narrow neck and black screw cap with standard thread. Also referred to as "Medicine bottle".



Item: 055560

Reagent bottle, 1000 mL, amb

Brown glass bottle with narrow neck and black screw cap with standard thread. Also referred to as "Medicine bottle".



Item: 055650

Cap for medicin flask, black

Lid for "Medicine bottle". Black screw cap with standard thread.



Item: 678110

Weighing Boat, Blue, 5 mL

Plastic weighing boats, intended for weighing different small quantities on a scale without contaminating the weighing platform. 500 pcs, color:



Item: 691030

Glue Gun, 8 mm, 10 W

Adhesive gun 8mm 10W black universal



Item: 691034

Glue sticks, all temp.

Adhesive bars alltemp 8 x 110 mm. 100 pcs



Item: 670136

Isotope generator, Cs-137/Ba-1

An alternative from Spectrum Techniques for extracting radioactive preparation for half-life determination experiments. Approximately 1000 test doses of Ba-137



Item: 545120

PE cuvette, 10 mm, down to 33

Square (10x10 mm) polyethylene cuvettes. Not for measurement in the UV range (However, due to extra good optical quality they can be used down to 330 nm, with



Item: 545140

Cuvette, quartz, 190 nm, 10 m

Cuvette in quartz glass. For measurement in the UV range. Comes with Teflon lid. Light path: 10 mm.



Item: 545150

Cuvette, plastic, UV, micro, 10 l

Replaces your quartz cuvettes* Can be used down to approx. 220 nm. 10 x 10 x 45 mm. Flamingo rack, 100 pcs. minimum sample volume 120 liters. Supplied without lid



Item: 545180

Lid for cuvette, 10 x 10 mm

Lid for 10 x 10 mm cuvettes made of light transparent plastic (LDPE) with resistance ribs to ensure a good seal.



Item: 545190

Cuvette stand for 16 cuvettes

Cuvette stand in gray polypropylene for 16 disposable 10x10 mm cuvettes placed in 2 vertically staggered rows of 8 cuvettes.



Item: 545940

Conductivity meter Dist5

Handheld conductivity meter from Hanna Instruments that is very easy to use. The device can measure conductivity and TDS (total dissolved solids) respectively.



Item: 570040

Box with lid, 82 x 122 x 32 mm

Storage box in gray impact-resistant plastic with clear lid. Width: 82 mm Length: 122 mm Height: 32 mm



Item: 570050

Box with lid, 82 x 122 x 52

Storage box in gray impact-resistant plastic with clear lid Width: 82 mm Length: 122 mm Height: 52 mm



Item: 570530

Open box, 175 x 224 x 60 mm,

L lidless box 175 x 224 x 60 mm (A5) made of plastic with layout options.

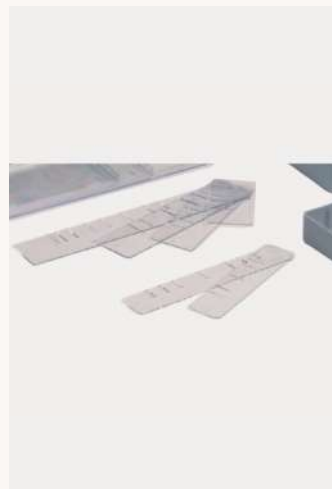

Item: 571520

Separator, 169 x 56 mm

This handy divider makes it easy to divide your storage boxes into smaller compartments and create an overview of materials and components. It fits perfectly in



Item: 571530

Separator, 218 x 56 mm

This handy divider makes it easy to divide your storage boxes into smaller compartments and create an overview of materials and components. It fits perfectly in



Item: 572345

Oddments box with separator

This Small Items Box with dividers is the perfect solution for keeping track of small objects, whether it's rocks, screws, lab supplies or anything else, you can easily



Item: 576506

System trolley, single, white

The system trolley solves the vast majority of transportation and storage tasks. The design of the trolley makes it easy to understand and use. Transportation between



Item: 576527

System trolley, treble, white

The system trolley solves the vast majority of transportation and storage tasks. The design of the trolley makes it easy to understand and use. Transportation between



Item: 576610

Tray, 75 mm, royal blue

The Granells system tray is specially designed for school and laboratory use. The tray is made of extra strong polypropylene and is fire retardant and anti-static. The



Item: 576620

Tray, 75 mm, flame red

The Granells system tray is specially designed for school and laboratory use. The tray is made of extra strong polypropylene and is fire retardant and anti-static. The



Item: 576624

Tray, 75 mm, grass green

The Granells system tray is specially designed for school and laboratory use. The tray is made of extra strong polypropylene and is fire retardant and anti-static. The



Item: 576625

Tray, 75 mm, sunshine yellow

The Granells system tray is specially designed for school and laboratory use. The tray is made of extra strong polypropylene and is fire retardant and anti-static. The



Item: 576627

Tray, 75 mm, light grey

The Granells system tray is specially designed for school and laboratory use. The tray is made of extra strong polypropylene and is fire retardant and anti-static. The



Item: 576628

Tray, 75 mm, translucent

The Granells system tray is specially designed for school and laboratory use. The tray is made of extra strong polypropylene and is fire retardant and anti-static. The



Item: 576631

Tray, 150 mm, royal blue

The Granells system tray is specially designed for school and laboratory use. The tray is made of extra strong polypropylene and is fire retardant and anti-static. The



Item: 576632

Tray, 150 mm, flame red

The Granells system tray is specially designed for school and laboratory use. The tray is made of extra strong polypropylene and is fire retardant and anti-static. The



Item: 576635

Tray, 150 mm, sunshine yellow

The Granells system tray is specially designed for school and laboratory use. The tray is made of extra strong polypropylene and is fire retardant and anti-static. The



Item: 576637

Tray, 150 mm, light grey

The Granells system tray is specially designed for school and laboratory use. The tray is made of extra strong polypropylene and is fire retardant and anti-static. The



Item: 576638

Tray, 150 mm, translucent

The Granells system tray is specially designed for school and laboratory use. The tray is made of extra strong polypropylene and is fire retardant and anti-static. The



Item: 576641

Tray, 300 mm, royal blue

The Granells system tray is specially designed for school and laboratory use. The tray is made of extra strong polypropylene and is fire retardant and anti-static. The



Item: 576642

Tray, 300 mm, flame red

The Granells system tray is specially designed for school and laboratory use. The tray is made of extra strong polypropylene and is fire retardant and anti-static. The



Item: 576644

Tray, 300 mm, translucent

The Granells system tray is specially designed for school and laboratory use. The tray is made of extra strong polypropylene and is fire retardant and anti-static. The



Item: 010680

Volumetric flask, DURAN, 10 m

Measuring flask in DURAN glass. With LDPE stopper

Volume: 10 mL
NS: 7/16



Item: 010690

Volumetric Flask, 25 mL, Boros

Borosilicate glass volumetric flask with polypropylene stopper

Each flask is individually machine calibrated at 20°C



Item: 014400

Micropipette Capp, 0.2-2 µl

Quality pipette from Danish Capp. Highly sensitive pipette with interval 0.2-2 µL

The bravo model has a



Item: 016000

Watch Glass, Ø70 mm

Glass with flame polished edge. Can be used for e.g. heating and vaporization.

Diameter: 70 mm



Item: 016010

Watch Glass, Ø80 mm

Good quality glass with flame polished edge. Can be used for heating and vaporization.

Diameter: 80 mm



Item: 024320

Thermometeradapter, NS14/2

Thermometer adapter for ground glass (NS14/23) Ø: 8.5 mm. Can be used in distillation setups, for example.

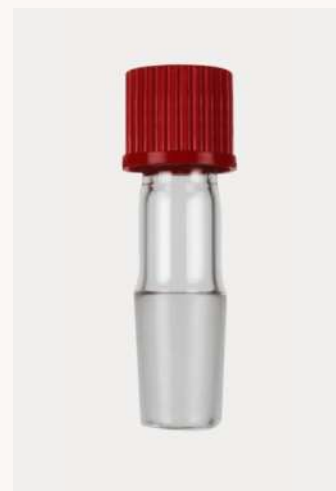

Item: 024330

Thermometeradapter, NS19/2

Thermometer adapter for ground glass (NS19/26) with a diameter of approx. 8.5 mm (outer Ø: 10 mm). The gasket in scouring cap fits 6-7 mm. round thermometers.



Item: 024340

Reducer, 19/26 - 14/23

Reduction adapter 19/26-14/23
Cap/outer (top): NS 14/23
Cone/inner (bottom): NS 19/26



Item: 024342

Reducer, 24/29 - 19/26

Reduction adapter (NS24/29 - NS19/26). Made of borosilicate glass. Cone NS24/29, cap NS19/26



Item: 024360

Glass stopper with NS19/26

Glass stopper with NS grind (19/26) and hexagonal grip.
Fitting flasks:
024095: Round bottom flask, 50 mL, NS19/26
024100:



Item: 024370

Glass stopper with NS24/29

Glass stopper with NS grind (24/29) and hexagonal grip.
Fitting flasks:
024120: Round flask, 100 mL, NS24/29
024140: Round



Item: 024380

Enlarging adapter, NS 14/23 - 1

Expansion adapter (NS14/23 - NS19/26). Made of borosilicate glass. Cone NS14/23, cap NS19/26



Item: 024381

Enlarging adapter, NS 19/26 -

Expansion adapter (NS19/26 - NS24/29). Made of borosilicate glass. Cone NS19/26, cap NS24/29



Item: 024500

Gas Wash Bottle, including Ins

Air collection bridge in resistant glass. With side cut-out. 100 mL
Height x width: 100 mm x 50 mm
Hose nozzle: Ø 15 mm



Item: 024501

Insert for gas wash bottle 024

Inserts for wash bottle. (Fits wash bottle no. 024500)



Item: 025300

Glass for melting point determ

Glass part for determining melting point.
Used with melting point tube (no. 020400) attached to cork stopper (no. 047510). Fill with



Item: 049000

Tongue depressor/lollipop stic

Tongue spatula in wood.
Dimensions: 150 x 18 x 2 mm



Item: 049510

Spatula, glass, Ø7 x 300 mm

Glass spatula. Length: 300 mm. Handle Ø: 8 mm. Plate Ø: 14 mm.



Item: 049610

Spatula, Stainless Steel, 21 cm

Double-bladed stainless steel spatula. 21 cm long with 10 mm blade.



Item: 049620

Spatula, micro, stainless steel,

Microspatula made of stainless steel. Length: 16 cm.



Item: 053780

Plastic can, 5 L, approved 40m

Plastic canister (disposable) with handle.

Specifications and features

- Inner neck diameter 36 mm



Item: 053785

Capsule, 40mm, pack/lock

Capsule, 40mm, pack/lock



Item: 053846

Safety Cap for 500/1000 mL K

Safety capsule for plastic bottles, with ring to see if the bottle has been opened.



Item: 054100

PET-bottle, 1500ml

Reserve bottle for 212110 (Rokit).

1,500 ml PET bottle universal, plastic, opening: PCO28 - for



Item: 065000

Magnetic stirrer with heating,

Quality magnetic stirrer with heating and timer function. With PT1000 temperature probe and electrode holder, which ensures full control over the



Item: 066815

Electric Kettle, 1,7 L, 2025W

This kettle is a powerful and versatile device that is ideal for school labs and experimental rooms. With a capacity of 1.7 liters and a high power output of 2025



Item: 076510

Reserve cartridge for SILEX 1C

Cartridge for 076500 SILEX ion exchanger. Capacity: Typically 500 L at 10° hardness. The cartridge can be



Item: 085554

Lab Jacket, L, 100% Cotton

White lab coat in 100% cotton in good quality. The lab coat is equipped with press studs and has 2 external side pockets and 1 external chest



Item: 085555

Lab Jacket, XL, 100% Cotton

White lab coat in 100% cotton in good quality. The lab coat is equipped with press studs and has 2 external side pockets and 1 external chest



Item: 149520

Stop clock, table-top model

Quartz controlled analog demonstration stopwatch - a reliable and accurate stopwatch that can be placed on either a table or wall, and is ideal for use in teaching



Item: 503301

Zip bags 150 x 250 mm

Re-sealable plastic bags, dimensions 150 x 250 mm. Also known as gripper bags. Packed per 50.



Item: 504098

Pipe Cleaners, Ø4 mm, 15 cm,

Pipe cleaner for cleaning glass or hoses with a diameter of 4 mm.
Length: 150 mm.
100 pcs.



Item: 542201

pH-meter, Checker Plus

New generation pH meter in pocket format. The model is operated with a single button. You can select 1- or 2-point calibration of the device, automatic buffer recognition

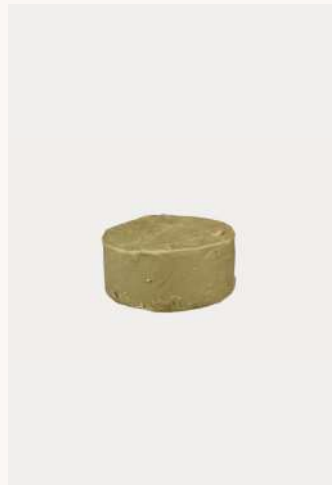

Item: 590000

Modelling Wax, Waterproof

Waterproof modeling clay in a 250 gram package.



Item: 590005

Modelling wax, standard

Modeling wax that does not dry out and is easier and softer to work with.
Pk. 500 g



Item: 591030

Rubber bands, approx. 110 pcs

Natural rubber elastic band. Size: 80 long - 1.5 mm thick. Weight 50 g; Contents approx. 190 pieces.



Item: 591040

Rubber bands, 3 sizes

Assortment of three different lengths of elastic bands in a practical divided box. The thickness of all elastic bands is 1.5 mm; lengths are



Item: 591050

Rubber bands, wide

Wide natural rubber band with a length of 140 mm and a width of 10 mm. Contains approximately 200 pieces / 500 grams.



Item: 704300

Cutting mat/board, small

Made of natural white, cut-resistant plastic that is easy to clean. Thickness 1 cm - 15 x 25 cm.



Item: 704305

Cutting mat/board, large

Made of natural white, cut-resistant plastic that is easy to clean. Thickness 1 cm, 25 x 35 cm.



Item: 825900-1

EDTA disodium, 100g

EDTA disodium can chelate metal ions and form stable complexes that prevent the metal ions from participating in chemical reactions.



Item: 851100-1

Potassium iodide, pure, 100 g

Molecular weight: 166.01
Purity: Pure CAS: 7681-11-0



Item: 871100-3

Sodium thiosulfate, techn. 500

Synonym: Fixer Salt Formula: $\text{Na}_2\text{S}_2\text{O}_3 \cdot 5\text{H}_2\text{O}$ Molecular Weight: 248.18 Purity: Technically Pure CAS: 10102-17-7



Item: 884200-2

Stearic acid, pure

Synonym: Octadecanoic Acid
Formula: $\text{CH}_3(\text{CH}_2)_{16}\text{COOH}$
Molecular Weight: 284.49
Purity: Pure CAS: 57-11-4



Item: 896100-2

Zink, clippings (10 mm)

10 x 10 mm zinc plates.



Item: NL118322

Microspatula, 200 mm

The Stainless Steel Micro Spatula, 200 mm is the ideal tool for precise handling of small amounts of powdered chemicals. With a blade width of 5 mm and a spoon width of



Item: 000420

Stand base, square

Stubby tripod base with square end faces for great stability. Lacquered cast iron with hole (Ø: 10 mm) and clamping screw.



Item: 052005

Tub, round model, 8 L

Bin made of white, impact-resistant plastic (not PVC)

Volume: 8 L Height: 12.5 cm
Outer diameter: 33.5 cm Inner diameter: 29.5 cm

Biology

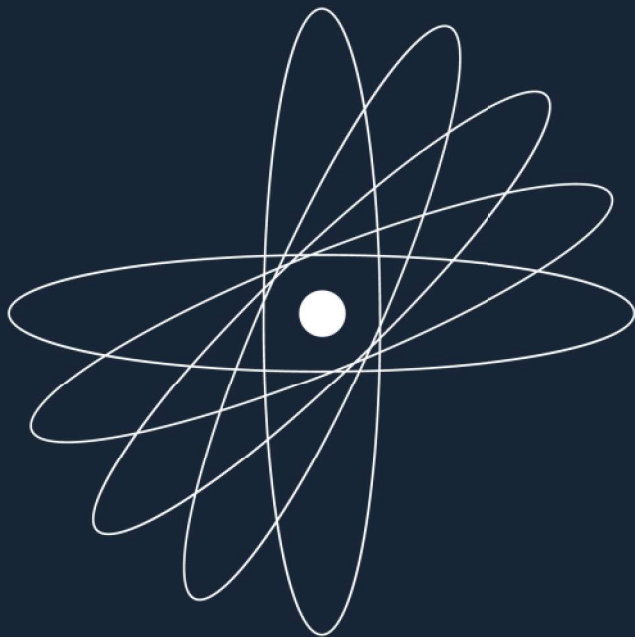

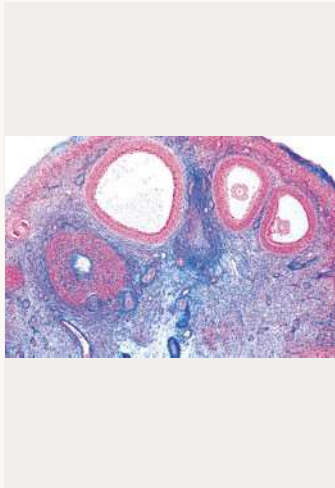

Item: 079200

Ovary, cross-section, microslid

Single slide
In an ovarian micro slide you can see the structures and cells that play a role in a woman's follicle maturation

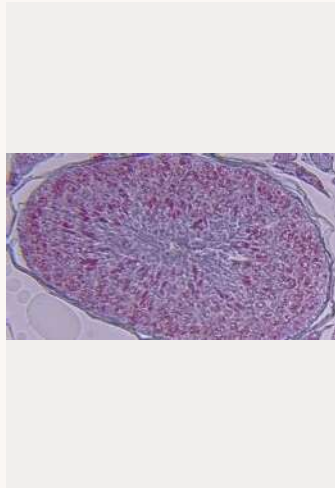

Item: 079205

Testicle, cross-section, microslid

Single specimen
In a micro specimen of a testicle, you can see the structures and cells that play a role in male sperm



Item: 077433

Microscope FS-1, trinocular, 60

Trinocular microscope with LED light, great design and good value for money. An obvious choice for demonstration use in schools, as it is of course equipped

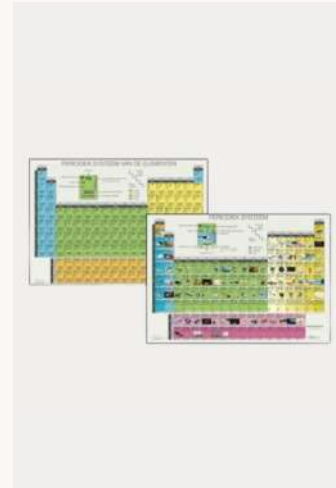

Item: 529002

Periodic System, poster, 120 x

Double-sided periodic table with images of the individual elements.
This smart 120 x 85 cm periodic table is a great

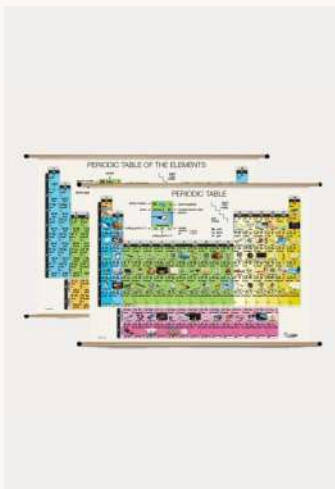

Item: 529005

Periodic System, hanging, 2-si

This



Item: 565607

Smartphone Adapter for Micr

With this sturdy adapter - made of aluminum - it's easy to take good pictures with your smartphone through the microscope eyepiece.



Item: 085110

Solar eclipse viewers

From German Baader Planetarium and equipped with a high-quality solar film that ensures 100% UV protection, 100% IR protection and reduces the



Item: 076766

Dust cover, large

Fits large microscopes and stereo loupes such as PrimoX, NeoX, NeoLab, NeoZoom, model 60 and trinocular

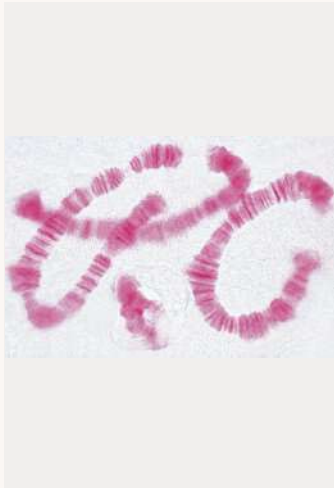

Item: 079175

Giant chromosomes, microslid

Single preparation. Salivary glands from the Chironomus larva.

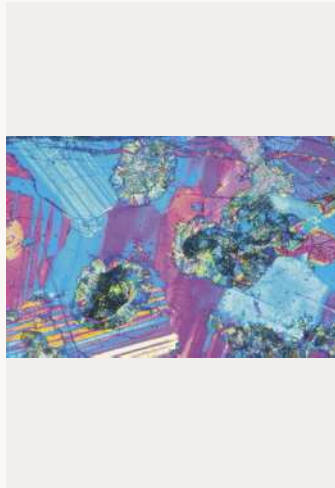

Item: 079185

Rocks and minerals, 10 different

Series 7920. 10 specimens with a selection of rocks and minerals. Place the specimen in the microscope and identify rocks



Item: 078113

Digital Microscope Camera, 4

This microscope camera features a square, robust metal body, fast and sharp image with direct HDMI output. 4K resolution (video) at 30 FPS. The microscope



Item: 791041

Greenland map large – 99 x 1

Map of Greenland. Printed on sturdy paper and single laminated. Laminated is such that the maps do not shine and are visible from all angles



Item: 078780

Razor blades

Ordinary razor blades with 3 holes. Individually packed with 10 pieces per pack. Can be used as a glass scraper.



Item: 078790

Scalpel blade remover

For safe and easy removal of used scalpel blades with metal handles. Insert the scalpel blade - press the button and -



Item: 078800

Scalpel handle no. 4, includes

Scalpel handle size 4 with 5 loose scalpel blades no. 24. Handle length: 14 cm. The number 4 refers to the design of the scalpel blade



Item: 078803

Scalpel, disposable scalpel, bl

Disposable scalpel - sterile. Curved scalpel blade size 23 - firmly attached to plastic handle. Total length: 16 cm



Item: 078804

Scalpel blade no. 24, curved e

Wide curved scalpel blade size 24 for scalpel handle size 4 (078800)



Item: 078806

Scalpel blade no. 25, straight

Spear-shaped straight scalpel blade size 25 for scalpel handle size 4.



Item: 078808

Dissection knife, simple

Simple dissection knife for slightly rougher work than a scalpel. Suitable for e.g. fish dissection where you want to open up the brain.



Item: 078809

Insect tweezers

"Soft" tweezers in thin stainless steel for gentle handling of e.g. insects. Length: 10 cm



Item: 078813

Students' microtome

Turn handle with razor blade. The handle is made of plastic and acts as a holder for the razor blade. When the handle is rotated in relation to the rest of the microtome, thin



Item: 078852

Cell division root/onion, 25 sp

25 preparations showing mitosis in an onion root tip. The set consists of 25 specimens, which are labeled with an English description of the specimen. Slight



Item: 078853

Microscope slide set, botany

Priced basic kit from the world of botany. An overview of the preparations can be downloaded under



Item: 078854

Microscope slide set, histology

Affordable basic histology kit with specimens from human, rabbit, dog, frog and more. Contents:
1. dog esophagus c.s.



Item: 078855

Microscope slide set, zoology,

Affordable basic kit from the world of zoology. An overview of the specimens can be downloaded under "documents" below and is

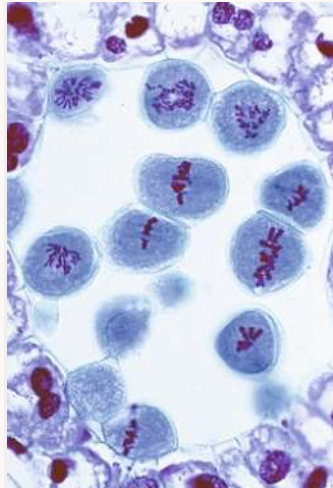

Item: 078861

Mitosis and meiosis, 6 differen

Botanical and zoological mitosis and meiosis specimens, 6 in total Showing all stages of mitosis and meiosis.



Item: 078905

Dissection set

Complete set for the lab or to take into the field. **Contents** 1 pair of nursing scissors with knob (078700) 1 pair of pointed dissection



Item: 078910

Dissection tray

Aluminum tray with vinyl sheet for use in dissection. The vinyl sheet is odorless and replaces wax in the dissection tray. The vinyl sheet can be easily removed



Item: 078970

Haematocrit tubes with sodiu

With sodium heparin (anti-coagulant) on the inner surface, red color code, for capillary blood For use with hematocrit



Item: 078975

Wax plate for sealing haemato

With 24 numbered holes for hematocrit tubes per plate. Even wax layer ensures uniform sealing.



Item: 079102

Microslide case, type K-50

For 50 micro preparations. Solid box lined with hinged lid. With imitation leather lining and numbered divisions.



Item: 079104

Microslide case, type PK-25

For 25 micropreparations. Heavy-duty molded plastic box with compartments for 25 micropreparations. Clear plastic lid. Suitable for

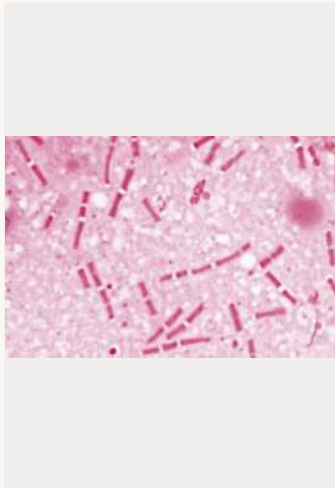

Item: 079120

Bacteria, series of 25 specime

Series 3000. Disease and epidemic-causing species and food spoilage by bacteria
The 25 preparations are delivered together in a



Item: 079130

Botanical and zoological basic

Series 500. Basic preparation set with a wide selection of zoological and botanical material.
 All 25 specimens are

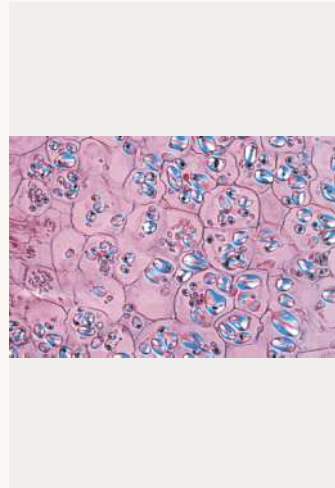

Item: 079135

Plant cells, 12 microsides

Series 5100. Series of 12 selected preparations of different cell types in plants.
 Supplied in specimen box
 Skin (Epidermis) Onion.

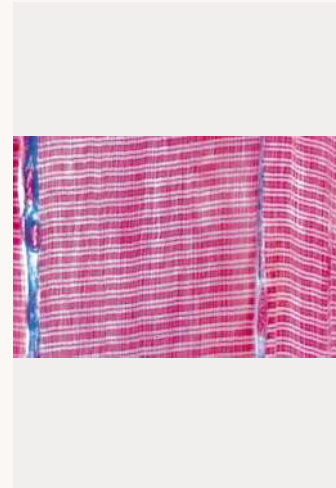

Item: 079140

Animal cells, 12 microsides

Series 5000. Series of 12 selected preparations of various animal cell tissues.
 Supplied in slide box.
 Sheet epithelium Mucosa (

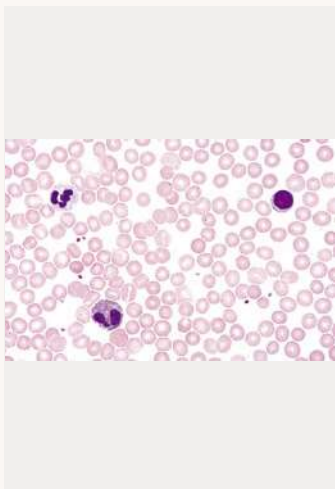

Item: 079145

Human blood, microslide

Single preparation

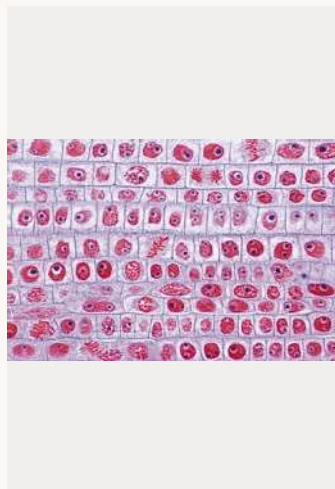

Item: 079150

Mitosis, root tip of onion (Alliu

Single preparation



Item: 079155

Life in a water drop, 25 differe

Series 7000. Gain insight into the rich animal and plant life found in water. 25 specimens - supplied in specimen box
 Amoeba proteus - Amoeba (

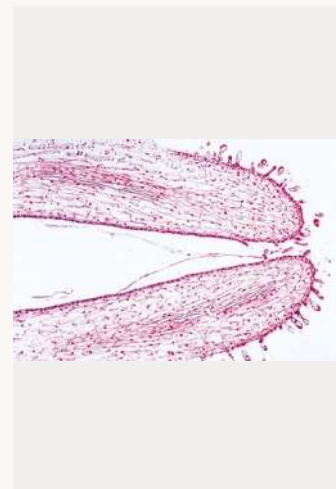

Item: 079160

Genetics, 25 microscope spec

Series 76000. Series of 25 selected preparations of various genetic preparations.
 Supplied in preparation box
 Mitose - Onion. Root tip of



Item: 782561

Urine test stix, Glucose

For measuring glucose concentration in liquids. Primarily used for testing glucose in urine, but can be used as an indicator in other



Item: 085710

Couch Roll, Bench Protection

Cheap alternative to the expensive table protection paper. The paper is coated with polypropylene on the back



Item: 534010

Periodic table with cast eleme

[Periodic table](#) with 83 elements cast in acrylic. This is a unique opportunity to see examples of many of the pure elements of the periodic table, which is a great way to



Item: 527575

Translation model, magnetic

Magnetic model for replication and transcription. A great tool to develop their modeling skills. Teach students about how



Item: 527576

Magnetic model, Replication

Magnetic model for replication and transcription. A great tool for developing modeling skills. Teach students about how



Item: 774790

Magnetic model , body, big

Magnetic body model of a man. The poster is made of a magnetic material that allows it to be attached to a



Item: 761530

Aquarium without lid, 11 L, stac

Very solid plastic aquarium that can be stacked to take up minimal space in cabinets. Designed so that the sides do not touch each other on stacked aquariums. This



Item: 038512

Aquarium hose, Ø4/6 mm

Plastic hose in clear PVC for Rena and Tetrattec pumps Supplied in rolls of 5 m. Inv. diameter: 4 mm Out. diameter: 6 mm



Item: 761531

Lid for aquarium 761530

Lid for the stackable aquarium 761530.



Item: 185000

Hair hygrometer

For measuring humidity in the range 0-100%.
Diameter: 10 cm.
With chrome-plated edge.
Adjustable.



Item: 185610

Psychrometer

For measuring relative humidity.
Never needs to be adjusted.
Therefore very suitable for both stationary and field use.



Item: 185715

Weather station, analogue

Simple weather station consisting of a weatherproof aluminum frame mounted with 3 separate and easily readable instruments, barometer, hygrometer and



Item: 078704

Dissecting scissors, curved ed

Pointed scissors with curved stainless steel blade. Length: Approx. 11 cm.



Item: 068027

Memmert test tube stand, 90

Fits in Memmert shaker basket (068020). With room for 90 test tubes with max. diameter 18 mm.



Item: 076853

Blue filter, Ø32 mm

Blue filter with a diameter of 32 mm. Placed in the condenser filter holder.



Item: 077000

Stereo microscope, model Min

A low-cost stereo magnifier in strong plastic material that can be used both indoors and outdoors. The battery-powered overhead light allows you to get extra light



Item: 077025

Stereo microscope, 30B (10x/

Stereo magnifier with a good and sharp optics. Lens head with 45° rotated eyepiece tube with diopter adjustment on the left eyepiece and adjustment for pupil distances



Item: 077026

Stereo microscope, model 30

Stereo magnifier with a good and sharp optics. Lens head with 45° rotated eyepiece tube with diopter adjustment on the left eyepiece and adjustment for pupil distances



Item: 077035

Stereomicroscope, model 30 L

Transportable stereo magnifier with the same optical specifications as model 30B (077025), but with significantly different lighting. Where stereo magnifiers



Item: 077043

Bulb, 12V/10W, halogen

For the top light on model 40B (077040), the bottom light on stereo magnifier Primozoom II (077063), the top and bottom light for older models of Primozoom II and



Item: 077050

Stereo microscope, model 60

Our largest stereo magnifier with 2 fixed magnifications. It is especially characterized by having good, powerful mechanics and very good optics that are razor-sharp.



Item: 077051

Eyepiece 20x, model 60/NeoZ

For use with stereo magnifier Model 60 (077050) or zoom stereo magnifiers NeoZoom (077150-51). Doubles the magnification compared to using the standard 10x



Item: 077053

Bulb, 12V/15W, halogen

12 V / 15 W halogen. For the underlight on stereolup model 60 (077050) purchased before October 2016.



Item: 077068

Glass Stage Plate, 95 mm

Matt glass plate ø95mm, used for stereo loupes 077025-26 30B/30C, 077035 30LED, 077040-41 40B/40C, 077050 Model 60 and 077061 Primozoom



Item: 077079

Eyepiece, 20x WF, Model 30/4

Fits the 30B/C/LED (077025-35), 40B/C (077040-41) and Primozoom II (077061) stereo loupes. Doubles the standard magnifications.



Item: 077085

Eye cups 2 small, for stereo mi

For stereo loupes with 34 mm eyepiece diameter.



Item: 077150

NeoZoom, binocular

Binocular zoom stereo magnifier with stepless magnification between 7x and 45x. The stereo loupe has good, sharp optics and powerful mechanics. The



Item: 077151

NeoZoom, trinocular

Trinocular zoom stereo magnifier with stepless magnification between 7x and 45x. The stereo loupe has good, sharp optics and powerful mechanics. The



Item: 077152

Dark Field Condenser, NeoZoo

A dark field condenser is a great tool for viewing zooplankton and other small non-contrasting organisms that are difficult to see. When using a dark field condenser,



Item: 077153

Micrometre eyepiece, NeoZoo

A micrometer eyepiece is a 10x magnification eyepiece with a micrometer - a measuring scale to determine the length and width of everything you look at in the



Item: 077155

Auxiliary lens, 2x, NeoZoom

Front lens 2x, used for stereo loupes 077150 and 077151. Doubles the magnification so the normal magnification range becomes 14x-90x.



Item: 077420

Microscope FS-1, monocular, 6

Student microscope with LED light, great design and good value for money. An obvious choice for student use in primary schools, as it is of course equipped with a 60x



Item: 077422

Microscope FS-1, monocular, v

Microscope with LED light, nice design and good value for money. An obvious choice for demonstration use in primary schools, as it is of course equipped with a 60x



Item: 077425

Microscope FS-1, binocular 60

Microscope with LED light. An obvious choice for student use in primary schools. Ocular tube: Binocular Lenses: Achromatic



Item: 077430

Microscope FS-1, binocular, 10

Student microscope with LED light, great design and good value for money. A good choice for the slightly more advanced student use in primary schools, as it is



Item: 077870

Bulb, 12 V, 10 W

Pinol bulb. Fits stereo loupes model 30B/C (top and bottom light) and model 40B/C (bottom light).



Item: 078106

Digital microscope, USB, 5 MP

Smart little USB macro lens with 5 MP resolution and included tripod. The macro loupe is easy to use for viewing small details and surfaces and has a built-in



Item: 078401

Magnifying jar set, 078486, +

Consisting of 8 closed canning loupes with a black rim in a sturdy plastic transportation box with carrying handle.



Item: 078402

Magnifying jar set, 078437, + c

Consisting of 9 closed canning loupes with a black edge, housed in a sturdy plastic transportation box with carrying handle.



Item: 078706

Bone scissors

Very powerful angled scissors for cutting fish etc. Easily cuts thin bones, skin and plant parts. Stainless steel.



Item: 078710

Scissors, straight, pointed

Pointed scissors with straight edge. Made of stainless steel. Length: 110 mm.



Item: 078405

Three-lens magnifier, 3x/6x/10

Three-lens magnifier that can magnify 3x, 6x and 10x in plastic. The magnifications are exactly what you need in nature.



Item: 078407

Magnifying jar

A nice little can magnifier in hard, clear plastic. Ideal for field trips and nature walks with the little ones. An approx. 3 cm wide measuring field with mm divisions can be



Item: 078409

Hand-held magnifier, Ø50 mm

A magnifier with shatterproof "glass" that is especially suitable for younger students. The magnifier is made of hard transparent plastic and is



Item: 078418

Magnifying glass, Ø40 mm

Good little hand magnifier with two magnifications. Made of transparent hard plastic. Ready to put in your pocket and take out into



Item: 078419

Hand-held magnifier 3x, Dia. 9

Hand magnifier with plastic handle and large magnification range in glass. This traditional magnifying glass has a 9 cm diameter lens and a magnification of



Item: 078422

Folding magnifier, small

Nice little botanist magnifier in a solid metal housing. The magnifier magnifies 10x and has an active lens diameter of 15 mm. The glass lens is set in metal and can be



Item: 078423

Folding magnifier with LED

Fine botanist magnifier in a solid metal housing and with LED lighting, which is a really good help to see the fine details. The magnifier magnifies 10x and has a



Item: 078424

Folder Pocket Magnifier, 10x la

Large botanist magnifier in a solid metal housing and with a quality lens of 2.1 cm in diameter made of glass. The magnifier magnifies 10x and the large lens provides a nice



Item: 078425

Loupe with focus support, sm

Small magnifier with focusing support in clear plastic. The magnifier is placed on top of the object to be examined and ensures that



Item: 078431

Loupe with focus support, larg

The magnifier is placed on top of the object to be examined and ensures that the object cannot crawl out of the field of view while the focus is



Item: 078435

Three-way magnifier

A smart magnifier that allows you to look at an animal or plant from above, from the side and from below. The magnifier has 2



Item: 078436

Bug viewer with ventilation

Large magnifier where the 6 cm lens is specially mounted to ensure ventilation for the animals you are looking at. The large lens makes it particularly suitable for



Item: 078437

Specimen magnifier with extra

This magnifier has an extra magnifier built into the lid that can be tilted on and off. This means that 2 magnifications can be achieved: 2x and 4x respectively. The sides of the



Item: 078485

Two-way magnifier

Two-way container hatch with side and top view. Ideal for viewing both the top and underside of small animals and the like. View the small animal from above through



Item: 078486

Magnifying jar, 3.5x, black rim

A high-quality magnifier with approx. 3.5x magnification, the magnifying lens is mounted in the lid of a clear plastic box. The magnifier's diameter of 45 mm makes it



Item: 078525

LED ring light, 72 LEDs

Powerful LED ring light for mounting on zoom stereo loupes. Equipped with 72 LEDs that provide fantastic light and is especially recommended if extra



Item: 078607

Watch glass with glass lid

Solid glass block with large recess. Comes incl. glass lid. Measures approx. 4 x 4 cm. Useful for viewing aquatic organisms under a stereo magnifier, among other



Item: 078610

Microscope slides

Object glass with rounded edges
Dimensions: 76 x 26 mm



Item: 078612

Slide with 1 recess, 50 pcs.

Indispensable for examining daphnia, algae and more under a microscope.
Dimensions: 76 x 26 mm.
Thickness of the slide: 1.0 - 1.2 mm. Note! Pack of 50



Item: 078619

Labels for slides, 960 pcs.

Slide labels - Self-adhesive.
40 sheets. 24 pieces
Dimensions: 18 x 29 mm



Item: 078620

Cover glass, 18 x 18 mm

Cover glass.
Dimensions: 18x18 mm



Item: 078625

Cover glass, 24 x 24 mm

Cover glass.
Dimensions: 24x24 mm



Item: 078630

Slide blotting paper, block of 1

Block of 100 small sheets of slide tracing paper. Used to remove excess liquid in micro preparations. Dimensions: 4x2 cm



Item: 078635

Lens tissue

Lint-free lens paper (no. 1019). Free from sand and splinters. Dimensions: 90 x 72 mm



Item: 078636

Compressed air, dust remover,

Used for removing dust and other small particles from optics. Indispensable if you want to avoid scratching optical glass during subsequent cleaning with



Item: 078637

Optic cleaning fluid, 2 x 60 mL

Specially developed optics cleaning fluid from Zeiss. Gently dissolves most water-soluble and slightly greasy coatings on optics, so that the microscope/binoculars retain



Item: 078638

Brush, soft

For removing small particles and dust from microscope optics or for sorting anesthetized fruit flies. Also great for working with



Item: 078640

Tweezers, straight, blunt 13 cm

Pincet - Rounded tip. Made of stainless steel. Length: Approx. 13 cm.



Item: 078650

Tweezers, straight, pointed, 13

Pincet - Tip. Made of stainless steel. Length: approx. 13 cm



Item: 078655

Tweezers, straight, pointed, 10

Pointed and straight tweezers, stainless steel, 10 cm



Item: 078660

Tweezers angled and pointed

Pincet with angled tip. Made of stainless steel. With "grooves"/rough contact surface on the inside to pull out during dissection.



Item: 078670

Watch maker's tweezers, mag

For finer dissection tasks and sorting work.
With very fine tip.
Length: Approx. 11 cm



Item: 078680

Tweezers, straight, blunt, 25 c

Large stainless steel tweezers - 25 cm long.



Item: 078690

Tweezers, sterile, plastic, dispo

Tweezers that can be used under sterile conditions as they are supplied sterile.
The design of the tweezers makes them ideal for children



Item: 104715

Bathroom scales with body fat

Scale that measures body weight in kg, body fat in percent and calculates BMI.
Measuring time 5-10 seconds and memory for 4 persons



Item: 078695

Teasing Needle, Straight, Plast

Fornicated prep needle mounted in a plastic shaft.



Item: 076700

Microscope NeoLab, binocula

The NeoLab microscope is especially suitable for high school use, but can also be used in many other contexts such as laboratory microscope or teacher



Item: 076728

Eyepiece, 10x, standard

Standard 10x microscope eyepiece. Can be used as an additional eyepiece for vertical tube on 077422 or 077151.



Item: 076757

Stage micrometer, 1/100 mm, s

Object glass with printed 1/100 mm scale. I.e. 1 mm divided into 100 equal pieces. Used together with a measuring eyepiece when you want to determine



Item: 076764

Eyepiece reticle 10x, wide angl

Measuring eyepiece (micrometer eyepiece), 10x wide angle with inlaid measuring disk 1/100 mm. Used to determine the exact size of a detail in a



Item: 076835

Mini-microscope, DualScope

Battery-powered mini microscope in heavy plastic material with LED light. With three optical glass lenses (4x, 10x and 40x) and stage with object clip. The microscope



Item: 076840

Microscope, FL-100

An easy-to-use and robust student microscope with a horizontal stage and 45° eyepiece tube for a comfortable viewing angle. Revolver mount with 3 sharp



Item: 076845

Microscope, FL-100, LED

Identical to the traditional version of the Model 100FL except for the illumination, which is a stepless variable diode light (LED). The microscope is cordless as it is



Item: 076850

Mechanical stage for FL-100/F

For mounting on model FL-100 and FL-100 LED microscopes. Makes it easy to move the micro specimen by fractions of a millimeter.



Item: 076851

Bulb, 230V/20W for 100FL

Incandescent bulb suitable for the FL-100 microscope (076840).



Item: 076887

Lens, 60x, achromatic

Standard achromatic lens with 60x magnification. Together with a 10x eyepiece gives a total magnification of 600x. N.A. 0.85 and spring-loaded front. Does not require



Item: 076888

Lens, 100x, achromatic

Standard achromatic lens with 100x magnification, N.A. 1.25 and spring front. Together with a 10x eyepiece gives a total magnification of 1000x. Used with immersion



Item: 076952

Dust cover for microscope/ste

Fits standard size microscopes and stereo loupes.
For trinocular models and the large models (PrimoX, NeoX,



Item: 067700

Microcentrifuge, 8 x 1.5/2 mL,

Mini-microcentrifuge with space for 8 x 1.5/2 mL microtubes or 2 x 8x0.2 microliter PCR strips (separate rotor included).



Item: 067850

Microcentrifuge, Nuve, hemat

Compact NF048 14,000 rpm centrifuge for both microcentrifuge tubes and hematocrit tubes. Solid design with safety lock in the lid so the centrifuge cannot



Item: 067855

Angle rotor, Nuve, 24 x 1.5/2 m

For microcentrifuge 067850
Diameter: 83 mm
Max. capacity: 24 pcs. 1.5 or 2 mL micro tubes
Max. tube diameter: 11 mm



Item: 067856

Hematocrit rotor Nuve for 067

Rotor for microcentrifuge 067850.
Max. capacity: 24 capillary tubes (hematocrit tubes) Max. tube diameter: 0.75 mm



Item: 067861

Adapter, 200 µL, PCR for angl

For angle rotor 0678.55. 1 piece is used per PCR tube



Item: 067900

Centrifuge, Nuve, NF 200, 12 x

Table centrifuge for 12x15 mL centrifuge tubes. The centrifuge is programmable and has a safety lid so that the lid cannot be opened until the rotor has stopped



Item: 068015

Memmert shaking module for

Mounts on Memmert water bath (068010) so that this water bath becomes a shaker water bath. With frame for mounting shaker basket and accessories (not included).



Item: 068020

Memmert shaking basket with

Mounts on 068015. Clips for conical flasks are purchased separately. We recommend 068022 for 250/300 mL bottles, but other sizes are available on request. Holds 6



Item: 068022

Memmert clip for water bath,

Mounts on Memmert shaker basket (068020) and can hold 1 conical flask in the size 250/300 mL. 6 clips (068022) can be mounted in the shaker basket (068020)



Item: 161700

Tornado cap

Make a tornado in a bottle! This little cap connects two bottles - one empty and one full. When you turn the bottles upside down, the water flows from one bottle to the other



Item: 078697

Teasing needle, curved, angle

Stainless steel - needle and handle turned in one piece.



Item: 078700

Scissors, nursing scissors, rou

Scissors - straight with tip and knob. Made of stainless steel. Length: 140 mm



Item: 078702

Dissecting scissors, pointed

Sharp scissors with straight stainless steel blades. Length: Approx. 13 cm.



Item: 782515

Microcount Duo, bact.+ yeast/

Which is more clean? The toilet seat or the water dispenser? Examine bacteria, yeast and fungi easily with Mikrocount



Item: 078107

Microscope with stand, WiFi, 3

Smart little WiFi macro magnifier with 3 MP resolution and included tripod. The macro loupe is easy to use for viewing small details and surfaces and has



Item: 032700

Hand Protector Grip, -20 to +1

For safe handling of very hot or very cold bottles. Practical hand protector with effective palm and finger protection. Flexible silicone with

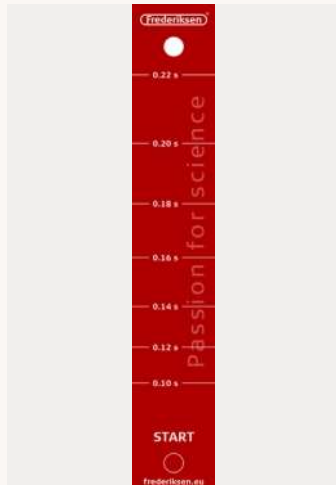

Item: 785012

Reaction time stick

For measuring reaction time in milliseconds. Interval: 0-220 milliseconds. A helper holds the reaction bar between the subject's



Item: 809100-3

Beeswax white, pure

Cleanliness: Clean.



Item: 140530

Folding rule, 2 m

The well-known carpenter's ruler made of white fiberglass with black lettering. The ruler can be folded and put in the pocket of your work trousers or field trip bag. A versatile



Item: 142800

Trundle wheel

The Meter Wheel is the smart choice for measuring areas such as sports fields, schoolyards or gardens. But it can also be used in geography lessons to teach

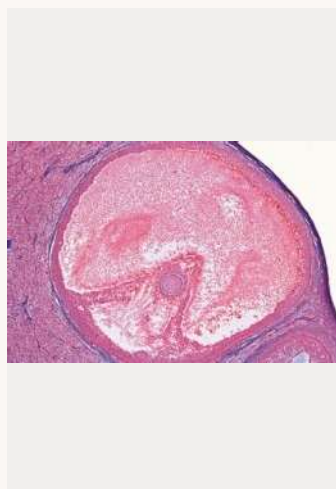

Item: NL210750

Prepared slide Ovary to show

"Similar" gestational sac, sec. selected to show Graafian follicle with detached oocyte. Sold 10 at a time. Note: Made to order,



Item: 065780

Test Tube Shaker Capp, 0 - 45

Smart little test tube shaker in a triangular design that promotes stability. The shaking frequency is adjustable from 0-4500 rpm.



Item: 066602

Water bath Nüve NB9, 7 L

The medium-sized water bath from Nüve with programmable microprocessor-controlled temperature control from room temperature +5 to 99.9



Item: 066604

Water Bath, NB20, 15 L

The largest water bath in the world with programmable microprocessor controlled temperature control from room temperature +5 to 99.9°C. With large dual digital



Item: 066620

Shaking Water Bath, Nüve, ST

Shaker water bath from Nüve. The water bath is microprocessor controlled and the tub is heated from both sides and bottom, so the heat is distributed better and



Item: 066639

Shelf, Stirrer, Erlenmeyer Flask

Shelf, shake, erlenmeyer flasks, 4 x 500 mL



Item: 838208

pH paper, 0.5-5.5, MN

Plastic cassette with indicator paper in rolls. A quality product from Macherey-Nagel. pH range: 0.5-5.5 graduation in pH: 0.5 The paper is impregnated with pH



Item: 140000

Tape measure, plastic, 150 cm

Traditional measuring tape in plastic with metal reinforcement at the ends. division in mm and cm. The division is in mm and cm as known from so-called



Item: 140010

Tape measure, metal, 2 m

Metal tape measure with self-winding and graduation in mm and cm. Length: 200 cm



Item: 140012

Tape measure, 3 m

3m, steel, in plastic housing.



Item: 140014

Tape measure, 50 m

The large tape measure for when you need to chalk up the pitch. A reusable tape measure with a metal ring at the end that



Item: 140015

Tape measure, GRP, 10 m

Glass fiber reinforced plastic tape measure in holder with roll-up mechanism. A handy tool for chalking up the roundball field or determining the aiming depth. The tape



Item: 140016

Tape measure, GRP, 30 m

Glass fiber reinforced plastic tape measure in holder with roll-up mechanism. A handy tool for chalking up the roundball field or determining the aiming depth. The tape



Item: 077455

Microscope Basic-S, monocol

Our new Basic series is characterized by being a slightly simpler monocular microscope than our normal FS-1 series (077420-33) at a very reasonable



Item: 779170

Corn (maize) seeds, segregati

Genetic experiment. American corn seeds that split green:albino in a 3:1 ratio
[Time schedule \(approximate](#)



Item: 779175

Corn (maize) seeds 9:3:3:1

American corn seeds that germinate green/albino and normal/dwarf in the ratio: 9:3:3:3:1 for



Item: 779180

Irradiated seeds, radish

Set of 5 x 50 radish seeds that have received different irradiation loads from a gamma radiation **Cobalt-60 source**. Cobalt-60 is a highly radioactive isotope that emits



Item: 785095

Reflex hammer

Used for the detection of reflexes.



Item: 785160

Eye magnification mirror, Ø50

Concave shape. Enables you to see with amazing clarity the fine structure of the outer eye, color differences in the iris as



Item: 785250

Colourblindness test, book

Fine color blindness book with nice illustrations to test and demonstrate color blindness. Both numbers and figures are shown in the



Item: 789510

Bottle garden, 6 L

New, smaller version of the well-known 20 L bottle garden 789500. With a volume of only 6 liters, you now get faster and more stable results. Lid with two holes for

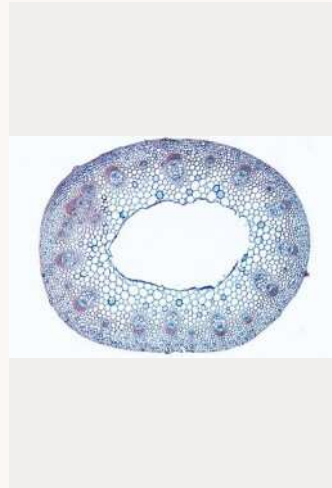

Item: NL212154

Ranunculus, buttercup ts open

Prepared specimen for microscope: buttercup, stem with open vascular bundles, no interfascicular cambium, t.s.



Item: NL212155

Chlamydomonas, small biflage

Prepared preparation for microscope: Chlamydomonas, small biflagellate algae.



Item: NL212162

Sperm smear, human

Prepared specimen for microscope: Sperm smear, human.



Item: NL212163

Ovary of rabbit

Prepared specimen for microscope: rabbit colostrum, t.s.



Item: 076710

Microscope NeoX, trinocular

Our top microscope NeoX builds on our popular high school microscope NeoLab, but with very significant upgrades added. NeoX is a great choice for either a



Item: 076756

Stage micrometer, DIV=0.1 mm

Object glass with printed 1/10 mm scale. I.e. 10 mm divided into 100 equal pieces. Used together with a measuring eyepiece when you want to determine lengths



Item: 077100

Stereolup, Trio-123

The 3 fixed magnifications in particular are a great advantage as they give you more magnification ranges to work with without having to invest in a zoom stereo



Item: 077101

Stereolup, Trio-124

Field trip stereo magnifier with good, crisp optics, practical carrying handle and great design. This stereo magnifier belongs to the Trio series, which is a clear step

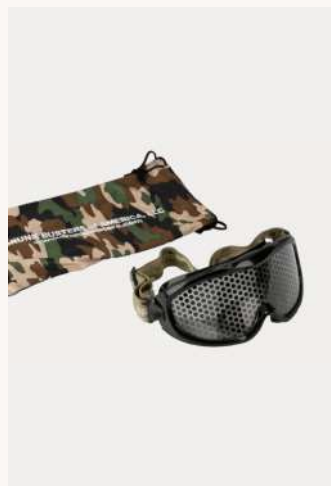

Item: 785350

Drug goggles

The drug goggles simulate many of the effects that the use of illegal drugs or drug overdose can cause. The goggles are designed to



Item: 890426

CO2 in water test set, Hanna

This is a test kit that measures carbon dioxide by titration with sodium hydroxide. The kit comes complete with all the reagents and equipment needed to



Item: 790100-2

LB broth, basis 200 g

Nutritional medium for the cultivation of bacteria. Recipe according to Luria-Bertrani (LB).

Contents Tryptone (



Item: 790120-1

LB Agar powder - 80g

Ready-to-use LB agar powder that yields approximately 200 agar plates (9 cm) per 100 g of substance.



Item: 790120-2

LB Agar powder - 200g

Ready-to-use LB agar powder that yields approximately 200 agar plates (9 cm) per 100 g of substance.



Item: 790128

LB agar tablets

Nutrient agar in tablet form (1.68 g) makes it easy to make finished agar without weighing ingredients (NOTE! Requires autoclave). The tablets have the same high



Item: 790130-1

YPD Broth, nutrient medium, 5

YPD broth ready-mixed powder for liquid growth medium. Used for selection of yeast strains with genetic defects in amino acid synthesis (mutants can grow



Item: 790140-1

YPD agar powder 100 g

YPD agar, ready-mixed powder for agar plates. Please note that the standard mix below does not have the same concentration as

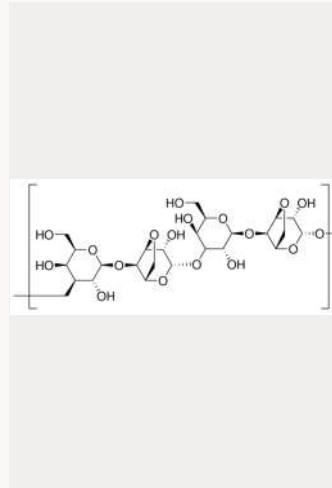

Item: 790200

Agarose, 10 g

For casting agarose gels



Item: 790210

2-Nitrophenyl beta-galactopyranoside

Synonym: ONPG, o-nitrophenyl-b-D-galactopyranoside 1 g
CAS: 369-07-3
Formula: C₁₂H₁₅NO₈

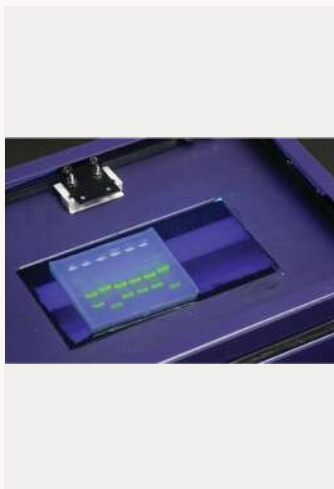

Item: 790530

SYBR Safe DNA stain for, 750

Newest DNA dye that is more sensitive to small amounts of DNA than ethidium bromide, but much safer for students and the environment.



Item: 140030

Ranging pole, 1.6 m

Surveyor stick with red and white markings and metal tip. A traditional tool for teaching students the principles of surveying, or a marker stick for a collection area,



Item: 785320

Impairment Goggles, 0.8 - 1.5,

Solid goggles in a ski goggle design that ensures a secure fit when moving. Simulates a blood alcohol level of 0.8-1.5 – well above the Danish limit for driving. The lenses are



Item: 785310

Impairment goggles, 0.4-0.6, g

Solid goggles in a ski goggle design, which ensures that the goggles stay firmly in place during movement. Simulates a blood alcohol level of 0.4-0.6, i.e. just



Item: 785330

Impairment goggles, 2,6-3,5, o

Solid goggles in a ski goggle design that ensures a secure fit when moving. Simulates a blood alcohol level of 2.6-3.5 – a very high blood alcohol level. The lenses of the



Item: 837538

pH sticks, 1-14, 100 pcs

100 pH strips 1-14. Discount version of the classic pH test strips, where four colored fields on each test strip are matched to a corresponding pH value on the outside of the



Item: 838008

pH paper, 1-11, MN

pH paper roll in plastic cassette with inlaid color scale from Macherey-Nagel. pH range: 1-11 Grade in pH: 1.0 Roll: 5.2 m x 10 mm



Item: 838038

Refill for pH paper, 1-11, 83800

Pack of 3 rolls of indicator paper from Macherey Nagel - for refilling cassette. The paper is impregnated with pH indicator color.



Item: NL210150

Hyaline cartilage of mammal, t.

Prepared specimen for microscope: Mammalian hyaline cartilage, s.t. Order from 10 pieces Note: Made to order, expected



Item: 544166

Gel tray, 7 x 7 cm Next generat

This new generation Gelkar is designed for Edvotek electrophoresis devices and measures 7 x 7 cm. It has 2 different positions for the comb, making it easy to



Item: 544167

Gel tray, 7 x 14 cm Next genera

Would you like to optimize your DNA electrophoresis teaching? Then this gel tray is the obvious choice. The gel tub fits perfectly with the Edvotek electrophoresis



Item: 778603

GoGel Agarose Gel, Pack of 10

Edvotek GoGel Agarose Gel Pack - the perfect solution for the busy biotechnology teacher. Designed for ease and convenience, these innovative single-use gel



Item: 790520

InstaStain Blue 40 sheets 7 x 7

InstaStain® Blue sheets color gels provide consistent, high-quality gel coloring with excellent results for photography. They are easy to use and environmentally



Item: 078117

Microscope camera, USB, 5M

This microscope camera can be connected to all Frederiksens Scientific microscopes. The camera is characterized

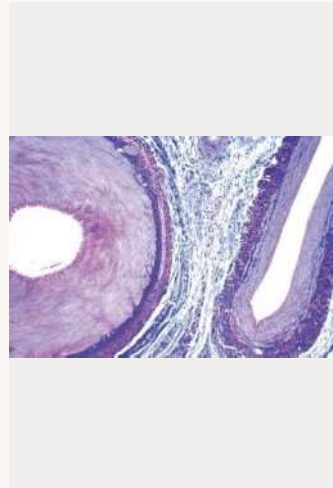

Item: 079220

Slide artery and vein of mamm

Single preparation
Order from 10 pieces Note:
Made to order, expected
delivery time 10-12 weeks
Color and shape of ordered



Item: 079225

Slide spinal cord of cat, t.s.

Single preparation
Order from 10 pieces Note:
Made to order, expected
delivery time 10-12 weeks
Color and shape of ordered

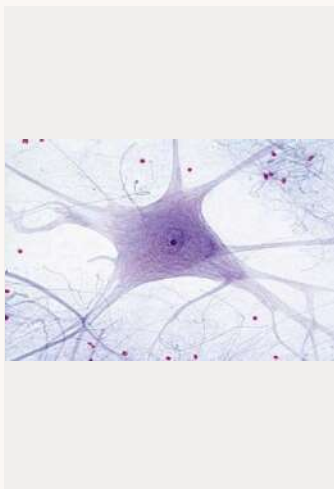

Item: 079230

Slide motor nerve cells

Micro preparation motor nerve cells, smear from spinal cord
Single preparation
Ordered from 10 pieces Note:

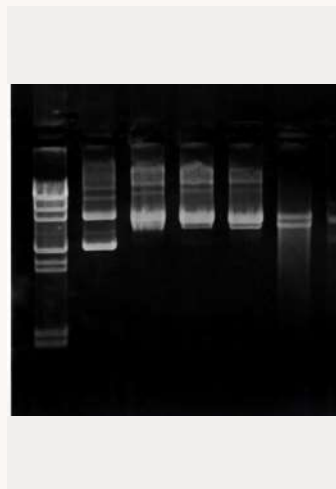

Item: 778957

UV Rays and DNA Damage

According to the World Health Organization (WHO), between 2 and 3 million cases of skin cancer occur worldwide each year. Many of these cancers are caused by



Item: 077450

Microscope Basic-A, monocol

Our new Basic series is characterized by a slightly simpler monocular microscope than our FS-1 series (077420-33) at a very reasonable price. The

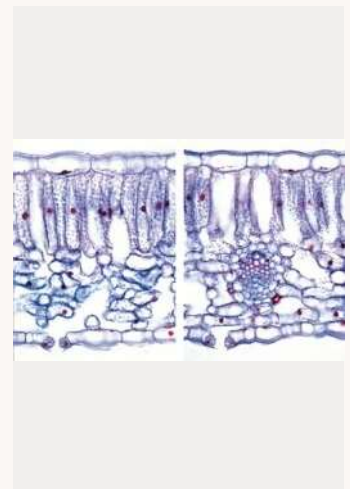

Item: NL212152

Prep Ligustrum, privet, t.s. of di

Cross-section of holly or privet; bipinnate leaves. OBS. Color and shape of ordered items may differ slightly from the picture due to the natural variation of biological



Item: 782105

Lactate strips for Accutrend/A

For lactate meter 782102
Accutrend Plus.



Item: 782162

Micro cuvettes, HemoCue

Disposable cuvettes for
hemoglobin photometer
782160.
In convenient single-piece
packs.



Item: 782180

Alcohol Breathalyser, AL-6000

Professional model for fast
and accurate measurements.
The breathalyzer can be used
both with mouthpiece ("active
mode") and without



Item: 782182

Mouth pieces for alcohol breaa

Fits 7821.80 Breathalyzer
AL6000. Very easy to
replace.



Item: 790650

Polyacrylamid gel 12%, ready-c

Pk. 3 pcs. for protein (vertical)
electrophoresis. With 10
wells. Dimensions: 9x10 cm
Edvotek states that the
polyacrylamide gels can be



Item: 791810

Map mounting bracket for ceil

Set of two brackets for
mounting a single self-rolling
card on the ceiling or wall.
"Roller blind bracket" for wall
or ceiling mounting.



Item: 792005

Rotating globe, satellite view, 1

Hold the world in the palm of
your hand and make people
swoon as you turn your hand
around while the globe
continues to rotate!



Item: 792020

Globe with light, Danish text,

Physical/political globe with
light, black plastic base and
transparent blue plastic
meridian. When the light is
on, the globe is political and
when the light is off it is



Item: 792040

Globe, relief, Ø30 cm

Relief globe that shows the land areas in 3D, highlighting mountain ranges in particular. The globe is lighted and thus also functions as a regular physical/political globe. I.e.



Item: 792045

Globe with magnet

Globe with built-in bar magnet. Used to simulate the Earth's magnetic field so that you can examine it with a magnetic probe (3435.00) or compass, for example.



Item: 792055

Write-on Globe, white, 30 cm

With outlines of continents, major country borders and major rivers.
4 dry wipe markers in different colors are included

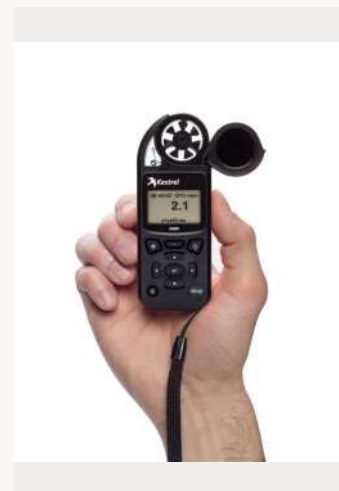

Item: 792095

Weather meter, Kestrel 5000

The Kestrel 5000 is the successor to the well-known Kestrel 4000, which is no longer produced. The new mini weather station (previously called climate



Item: 792096

USB Data Transfer Cable

Usb cable for transferring data from Kestrel 5000 mini weather station to computer (Mac/Windows). Also used for firmware updates of the Kestrel 5000. The transfer is



Item: 796015

Thermostat heater, Jaeger, 50

50 W thermostatic heater that can be used with the Greenland pump model 796020. Waterproof and with auto



Item: 796020

Ocean currents, the Greenland

This classic model for demonstrating ocean currents - including the Greenland Pump - was developed in collaboration with Danish high school



Item: 800500-2

Agar powder 200 g, normal q

Agar powder in bacteriological quality. Used as a thickening agent. Does not contain nutrients - if you want finished agar for growing fungi or bacteria,



Item: 800500-3

Agar powder 400 g, normal q

Agar powder in bacteriological quality. Used as a thickening agent. Does not contain nutrients - if you want finished agar for growing fungi or bacteria,



Item: 800638

Bromothymol blue lactose aga

Bromothymol blue agar for the cultivation and detection of coliform bacteria. When coliform bacteria are present, the agar changes



Item: 800718

Meat peptone agar, powder fo

For the cultivation of bacteria. Bag for 250 ml finished agar. This versatile meat peptone agar can be used for culturing most bacteria. The agar is



Item: 800728

Meat peptone agar.

For the cultivation of bacteria. A sterile knife is used to cut slices of the meat peptone agar sausage. Sterilize the knife by dipping the knife in alcohol and holding it in a



Item: 800738

Nutrient Agar, peptone meat e

This versatile meat peptone agar can be used for the cultivation of most bacteria. The agar is non-selective and is used for simple detection of bacteria. By adding more



Item: 800818

Malt extract agar, powder for

For the cultivation of mushrooms. Bag for 250 ml finished malt extract agar. This malt extract agar can be used for the cultivation of



Item: 800828

Malt extract agar, roll fungi. ex

For the cultivation of mushrooms. With a sterile knife, slices are cut from the malt extract agar sausage. Sterilize the knife by dipping the knife in alcohol and



Item: 800838

Malt extract agar in bottle, fun

For the cultivation of mushrooms. The bottle contains 250 ml finished malt extract agar. This malt extract agar can be



Item: 800940

PCA agar in bottle.

This versatile Plate Count Agar can be used to grow most bacteria and some fungi. The agar is non-selective and is used for simple detection of bacteria.



Item: 883320

Gravel, 3-6 mm, 3 L

Aquarium gravel with a stone size of 3-6 mm. can be used for water purification systems built in class.



Item: 077421

Microscope FS-1, mono, 100x

A student microscope with LED light, great design, 100x objective and good value for

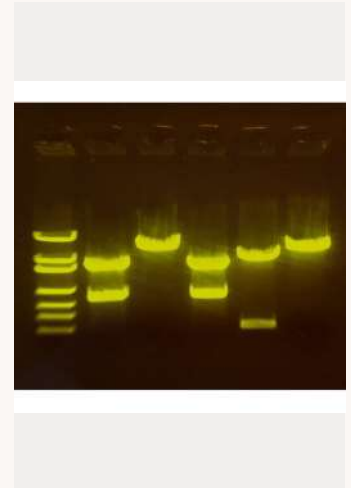

Item: 778210

A-maize-ing Editing: Using CRI

Edvotek Kit 210. Explore advanced biotechnology with this hands-on CRISPR-Cas9 simulation. Students step into the shoes



Item: 784021

Spirometer nozzles for Spirox (

Mouthpieces for Spirometer Spirox item no. 784020 Pack of 25 pcs.



Item: 778270

Antigen-Antibody Interaction:

Introduction of the principles of antigen-antibody interactions using the Ouchterlony procedure. Antibodies and antigens form complexes that precipitate,



Item: 778163

Edvotek kit 163 Developing a v

Vaccines are a powerful disease prevention tool. Vaccines are designed to train the human body to fight pathogens - without getting sick itself. In this Edvotek kit



Item: 782525

Hygicult TPC, total plate count

Quick hygiene test. The dip plate is coated on both sides with PCA agar, which supports the growth of the most common bacteria and molds. The plate is hinged at



Item: 784002

Mouthpieces for pocket spiro

For the discontinued model spirometer 784000.
Made of recycled cardboard
Inner diameter: \varnothing 10 mm
Outer diameter: \varnothing 12 mm



Item: 784010

Peak flowmeter, 60-800 L/min

To measure the largest exhalation measured in L/min. Place a disposable nozzle on the flowmeter (instead of the



Item: 784011

Mouthpiece for Peak flowmete

Disposable cardboard nozzles for Peak Flowmeter. The plastic nozzle is removed to make room for the cardboard nozzle.



Item: 763056

Mini greenhouse with heat an

Super smart little compact Mini Greenhouse 38 x 24 x 19 cm with ventilation, light and heat. Provides optimal growing conditions for smaller



Item: 078639

Microscope cleaning kit

Cleaning kit for microscopes. An indispensable cleaning kit for cleaning the microscope. The kit consists of:

- 10 wet wipes,



Item: 774792

Magnetic model, skeleton, big

Magnetic model of the body's bones. Fits the large body model (774790) where bones can be attached as both parts are



Item: 774795

Magnetic model, body, small

Magnetic model of the body showing a child. The poster is made of a magnetic material that allows it to be attached to a

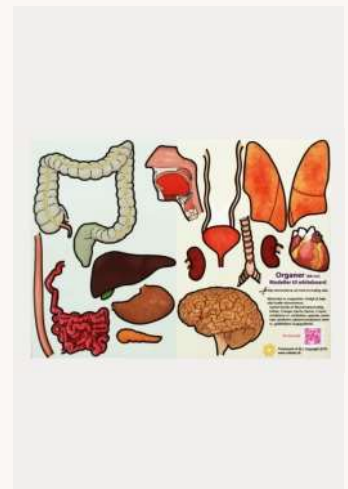

Item: 774796

Magnetic model, organs, small

Magnetic model of the body's organs. Fits the small body model (774795) where the organs can be attached as both parts



Item: 761051

Aqua net, with alu shaft

Water and bottom net, with aluminum telescopic shaft, lightweight and practical, pentagonal with wide flat bottom edge (22 cm), good for catching bottom animals



Item: 760711

Planktonnet, 250 µm, Ø30 cm,

A lightweight and practical plankton net for both plant and animal plankton. The plankton net has a strong metal hanger with 10 m of



Item: 781007

Water Cycle, magnetic poster

Magnetic material poster, ready to put up on a whiteboard/magnetic board. The poster shows all aspects and phases of the water cycle



Item: 763090

Grow Garden with light and w

Greenhouse with light source and self-watering system. The light source consists of LED grow lights at 6400 Kelvin, equivalent to bright

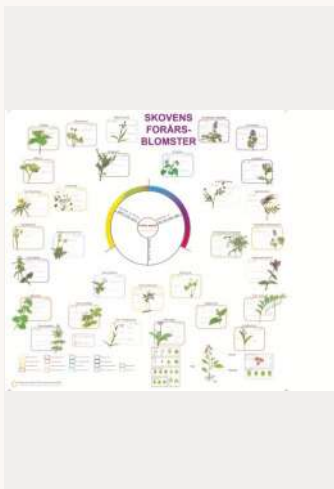

Item: 781022

Identification chart - Spring flo

Colorful identification tablecloth for identifying the flowering plants of the spring forest. The tablecloth also contains



Item: NL116551

Nutrient agar, 500 gram

Nutrient agar (2%) in powder form. Nutrient agar is a general purpose medium. Intended for the growth of a wide range



Item: 565606

Smartphone adapter with eye

With this sturdy adapter, it's easy to take good pictures with a smartphone through the microscope eyepiece. The adapter mounts in place



Item: 572220

Dissection instrument case,

Plastic box with lid, suitable for student sets of dissection tools or handy for storing tweezers, scissors and more. Dimensions: 18.5 x 8.5 x 3.2



Item: 779820

Sterile disks for antibiotics, Ø1

Small, sterile disks of filter paper that can be impregnated with various antibiotics, carbohydrates, plant extracts, antiseptics, etc. Can then be used for



Item: 779850

Streptomycin, discs for agar

Streptomycin disks for testing the effect of antibiotics on bacteria - placed on inoculated agar in Petri dishes.



Item: 779854

Neomycin, discs for agar

Neomycin disks for testing the effect of antibiotics on bacteria - placed on inoculated agar in Petri dishes.



Item: 779855

Erythromycin, discs for agar

Erythromycin disks for testing the effect of antibiotics on bacteria - placed on inoculated agar in Petri dishes.



Item: 779856

Tetracyclin, discs for agar

Tetracycline disks for testing the effect of antibiotics on bacteria - placed on seeded agar in petri dishes. Antibiotic disks are placed on



Item: 779859

Ampicillin, discs for agar

Ampicillin discs for testing the effect of antibiotics on bacteria - placed on seeded agar in petri dishes. Antibiotic discs are placed on



Item: 780003

Stethoscope, Nurse model

Model in Littmann design, with both diaphragm and cup. The powerful diaphragm amplification of the sound in combination with the perfect



Item: 780004

Stethoscope

Affordable stethoscope for physiology teaching.



Item: 780005

Stethoscope, dual

Quality model that allows two people to listen at the same time. Ideal for teaching students what to listen for during a blood pressure



Item: 780010

Eldoncards with blood lancets

Complete set for 30 tests within the ABO and Rhesus systems. With blood lancets and single plastic stirrers. With large eldon cards (7x10 cm). The Eldon cards contain

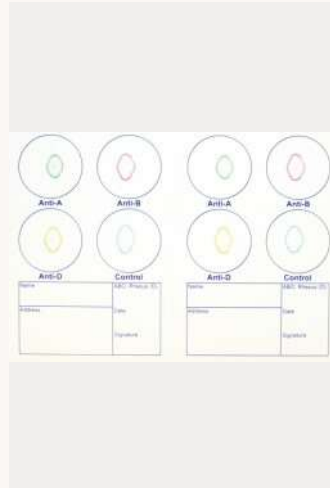

Item: 780015

Eldoncard with finger lancets

Complete set for 50 tests within the ABO and Rhesus systems. Eldon cards in credit card size (approx. 5x7 cm). The Eldon cards contain 4 fields of dried serum reagents



Item: 780025

Plastic stirrers, individual

200 plastic stirrers for eldon cards. An extra pack can be useful as the 780010 and 780015 sets only have exactly



Item: 780026

Sterilising wipes

Individually packed disinfection wipes. Useful for sanitizing before e.g. finger prick blood collection.



Item: 780030

Blood lancets

Solid disposable model without automatics. Single packaged.



Item: 780036

Blood serum, Anti-D, 10 mL

Blood typing of Rhesus + or Rhesus - without using an eldon card. 10 ml pipette bottle Store in the refrigerator. Shelf life approx. 12-15



Item: 780037

Blood serum, Anti-A, 10 mL

Pipette bottle with 10 mL anti-A serum. Used for blood typing without an eldon card. Store in the refrigerator. Shelf life: Approx. 12-15



Item: 780038

Blood serum, Anti-B, 10 mL

Pipette bottle with 10 mL anti-B serum. Used for blood typing without eldon card. Store in refrigerator. Shelf life: Approx. 12-15



Item: 780080

Blood typing kit ABO-Rh, simul

Simple and safe blood typing without using real blood. This complete kit for 30 tests contains simulated blood and simulated Anti-A, Anti-B and Anti-Rh sera. Blood typing is



Item: 780085

Refill for simulate blood type s

Refill for 780080 Blood Type Kit ABO-Rh - Simulated Blood
Contents Simulated blood from 4 different people (7 mL of each) Simulated Anti-A



Item: 780410

Blood pressure and heart rate

Good blood pressure monitor at a reasonable price. With clear display showing high (systolic) and low (diastolic) blood pressure and current heart rate. Comes with arm



Item: 780502

Blood pressure monitor, manu

Manual blood pressure monitor. Stethoscope ordered separately, more options available, see accessories.



Item: 780520

Blood pressure and heart rate

Fully automatic device with memory for the last 60 measurements. Clear display showing high (systolic) and low (diastolic)



Item: 780560

Blood pressure and pulse mo

Updated Omron RS4 model - now with memory for 60 measurements and



Item: 781015

Identification chart, Rocks/indi

Exciting determination cloth for stones/articulated blocks. Ledeblocks are stones that are almost certainly from a specific area somewhere in Scandinavia. They were



Item: 781023

Identification chart, Seaweed

Exciting new colored identification tablecloth for seaweed. Beautiful tablecloth with educational divisions and detailed color drawings.



Item: 781024

Identification chart, fungi

New, beautiful colorful identification tablecloth for forest mushrooms. Developed and illustrated by Benny Lindblad Johansen, lecturer in nature/technology



Item: 781025

Identification chart, saltwater f

Colorful identification tablecloth for saltwater animals at piers and beaches. Beautiful tablecloth with educational division and detailed color



Item: NL191104

Folding pocket magnifier, 5x/1

Triple magnifiers. Diameter 30 mm, magnification 5x, 10x and 15x. The housing is made entirely of plastic.



Item: NL210135

Prepared slide, yellow elastic c

Preparation: Yellow elastic cartilage, mens. sec. colored for elastic fibers.

Note: Made to order. If the product is not in stock, the



Item: NL116552

Petri dish, 9 cm, PCA, 10 pcs.

PCA agar in petri dishes ready to use. Precast PCA agar in 9 cm petri dishes. Ready for inoculation.



Item: NL116553

Rodac plate, 55 mm, PCA, 20

PCA (Plate Count Agar) contact plates (Rodac plate) of 55 mm. Ready to use. Easy to check surfaces. An impression of the hygiene status of the surface is



Item: 066743

Overpressure plug for VAPOU

Overpressure plug for VAPOUR-Line Lite II autoclave.



Item: 760726

Plankton net with line, 130 mic

Quality model, robust, heavy-duty quality for trapping both plant and animal plankton. The net has a strong metal bracket, with 10 m nylon line



Item: 838018

pH paper, 1-14, MN

pH paper roll in plastic cassette with inlaid color scale from Macherey-Nagel. pH range: 1-14 Graduation in pH: 1.0 Roll: 5.2 m x 10 mm



Item: 838028

Refill for pH paper, 1-14, 83801

Pack of 3 rolls of indicator paper from Macherey Nagel - for refilling cassette. The paper is impregnated with pH indicator color.



Item: 761805

Aquarium set 54 L, ready for u

Complete glass aquarium set, ready to use. The robust 54-liter aquarium comes with 10-watt LED lighting (with day and night mode), an easy-to-clean filter and a reliable



Item: 781026

Identification chart, Forest tree

Decoration tablecloth in colors for Danish trees. Beautiful tablecloth with educational division and detailed color drawings.



Item: 781027

Identification chart, Terrestrial

Beautiful colorful identification tablecloth for small terrestrial animals. The tablecloth has an educational division and detailed color drawings. Made of strong, white vinyl and



Item: 781028

Identification chart, freshwater

Colorful identification tablecloth for small animals in freshwater. Beautiful tablecloth with educational divisions and detailed color drawings.



Item: 781029

Identification chart, Trees in wi

Nice colorful tablecloth for Danish winter trees. Developed and illustrated by Benny Lindblad Johansen, lecturer in nature/technology and biology at the teacher



Item: 781030

Sorting sheet, 100 x 100 cm

White plastic tablecloth made of PE. Bring along on the trip as a seat mat or for sorting the catch. It can be placed under a bush and shaken to pick up small animals. Also

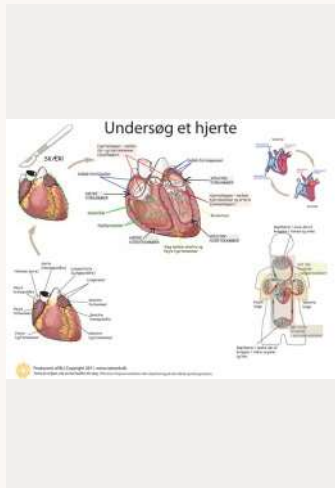

Item: 781035

Dissection sheet, Heart

Smart dissection mat for use when dissecting e.g. pig hearts. Dissections of the different parts of the heart are

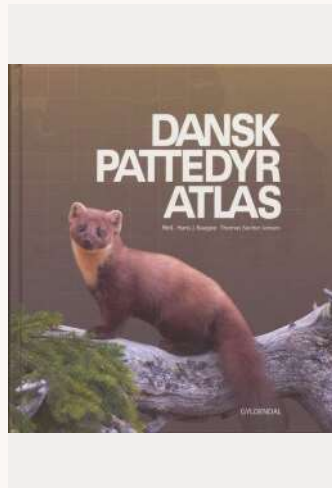

Item: 781462

Dansk pattedyratlas

The book is the first comprehensive description of the distribution of Danish mammals. It contains updated distribution maps for most of the 88 Danish



Item: 781500

Hand dynamometer digital

To measure the muscle force of the hand and forearm and the slowing down of the muscles during movement. When the handle is



Item: 771017

Brain, Neuro-anatomical, 8 par

This deluxe edition of a brain model is partially split. On the right half of the brain you'll find a colored, systematic grouping of brain



Item: 066680

Water bath BM30 with circulat

Water bath with circulation, ready to place on the table and get started. The water bath has a large, easy-to-read obbel display, one of which shows the water



Item: 066680L

Lid for water bath BM30, stainl

Reduces evaporation and shortens heating time.



Item: 066745

Autoclave, VAPOUR-Line Lite II

23L fully automatic table-top autoclave in aluminum alloy with temperature control and digital display, automatic air vent and double safety system. Pre-programmed



Item: 066746

Wire basket for VAPOUR-Line

Autoclave basket for VAPOUR-Line Lite II autoclave.
New, lighter model for easier handling.



Item: 066747

Sacrificial body for VAPOUR-L

Tearing ring for VAPOUR-Line Lite II autoclave



Item: 066748

Lid seal for VAPOUR-Line Lite I

Fits VAPOUR-Line Lite II autoclave.
Replace when it becomes stiff or tenderizes.



Item: 066777

Autoclave tape, 19 mm, 50 m,

Autoclave tape (paper) with color indicator for closing packages during autoclaving/steam sterilization.



Item: 778166

The spread of infectious disease

Edvotek #166.
Students simulate the spread of an infection using a dye that is only visible in UV light. A student is "infected" and

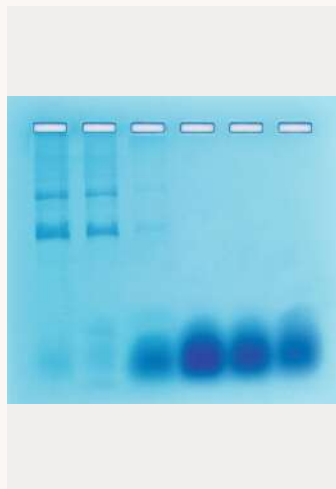

Item: 778204

Separation of DNA-RNA by ge

Students separate RNA and DNA from an RNA-DNA mixture (provided) using column chromatography. The result is then analyzed using horizontal



Item: 778221

Transformation of E.coli with p

Edvotek kit no. 221.
This experiment works with plasmid transformed bacteria. Insertion of the Lac+ phenotype in the transformed



Item: 778222

Transformation of E.coli with pl

Edvotek kit no. 222.
This experiment works with plasmid transformed bacteria. Using 2 different plasmids, a green or blue fluorescent



Item: 778223

Transformation of E.coli with G

Fun and classic experiment where students produce genetically modified microorganisms by transforming E. coli with the gene for green fluorescent

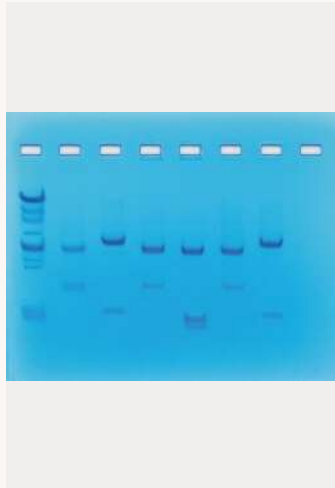

Item: 778225

DNA Fingerprinting II - Using

Edvotek kit no. 225. Application of restriction enzymes for DNA fingerprinting. An extended experiment on the use of restriction enzymes for the



Item: 778243

Column chromatography, ion

Edvotek kit 243. Exciting experiment where two chemicals in a mixture are separated and collected using an ion exchange



Item: 778271

AIDS test set I, the ELISA meth

AIDS is a severe immunodeficiency syndrome caused by the HIV virus. In this experiment, students will test simulated blood samples for the presence of antibodies



Item: 778273

Antigens, quantitative determi

Edvotek #273. With this test, the amount of antigen is determined quantitatively. The antibody is mixed into the gel, which is allowed to solidify. The antigen is placed



Item: 778274

Kissing Disease test set, ELISA

NB! Does not contain viruses or other pathogenic components. Can be used in biology and biotechnology to teach topics



Item: 778275

Western blot simulation, AIDS

Edvotek kit #275. Students use Western Blot to confirm a positive HIV ELISA result. Protein samples from hypothetical patients are separated on agarose gel and



Item: 778280

Diabetes test ELISA + urine gl

Edvotek kit #280. Students screen 3 potential patients for diabetes using both urine glucose tests and Enzyme-linked

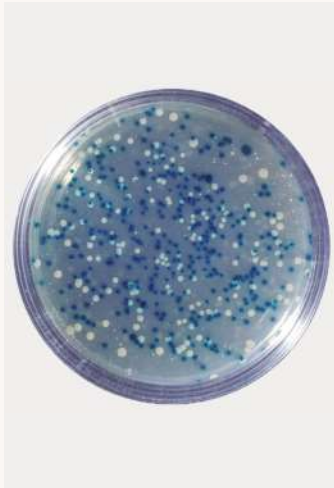

Item: 778300

Blue/white DNA cloning

Edvotek kit #300. Students ligate a linear plasmid using T4 DNA Ligase and then transform E. coli with recombinant plasmid. The number of recombinant



Item: 778303

Exploring biotechnology with

Edvotek kit #303. Is basically a combination of transformation kit 7782.23 and column chromatography kit 7782.25. Students transform E. coli with GFP



Item: 782025

Test strips Glucometer Contou

Test strips for blood glucose testing. Fits ONLY the Contour Classic glucometer (782020 - discontinued), the device is blue.



Item: 782035

Test strips NEXT Glucometer

Do you need to measure blood glucose levels? Then you can use our quality test strips for blood glucose testing! Designed for use with the Glucometer Contour



Item: 782102

Lactate/cholesterol meter Acc

Professional, handheld combination instrument that can measure blood levels of cholesterol and lactate (using separate strips).



Item: 847832

Rapitest, refill, pH, 8 capsules/

For refilling the pH test in the 847830 Rapitest soil test kit



Item: 847834

Rapitest, refill, N, 8 capsules/t

For refilling the nitrogen test in the 847830 Rapitest soil test kit



Item: 847836

Rapitest, refill, P, 8 capsules/te

For refilling the phosphate test in the 847830 Rapitest soil test kit



Item: 847838

Rapitest, refill, K, 8 capsules/t

For refilling the potassium test in the 847830 Rapitest soil test kit

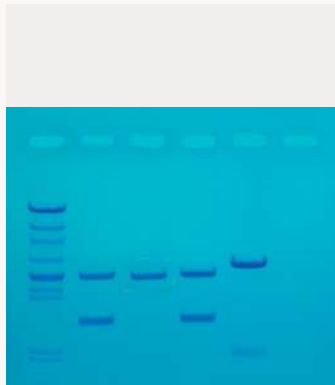

Item: 778130

DNA fingerprinting by PCR, re

Edvotek kit 130. The purpose of this experiment is to learn about DNA fingerprinting in crime solving.

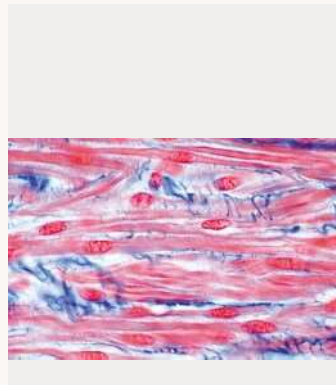

Item: NL210139

Prepared slide, smooth muscl

Smooth muscle tissue, human. Transverse and longitudinal sections. Smooth (involuntary) muscle, human l.s. and t.s.



Item: NL210207

Prepared slide, artery and vein

Artery and vein of man. Cross section, elastica coloring Artery and vein, human, cross section, elastica colored Order from 10 pieces



Item: 565721

Binoculars, FOCUS Observer,

Focus Observer 42 is an ergonomic, lightweight binocular that is easy to take with you in nature. Bright and sharp image with advanced anti-glare treatment that



Item: 838508

pH paper, 5.5-9.0, MN

Plastic cassette with indicator paper in rolls. A quality product from Macherey-Nagel. pH range: 5.5-9.0 graduation in pH: 0.5 The paper is impregnated with pH



Item: NL119620

Minit Organic and Inorganic St

Consists of 264 atomic nuclei and more than 200 pre-cut connecting tubes. Specifically aimed at (an)organic chemistry.



Item: 780058

Lancet 3 depths

Disposable finger pricker 3 connector depths. Preset to medium penetration depth in advance (1.8 mm). Select the one of the 3 penetration depths that suits the



Item: 781016

Bestemmelsesdug, sten på str

Nice colorful identification tablecloth for stones on the beach. Developed and illustrated by Benny Lindblad Johansen, lecturer in nature/technology and



Item: 781017

Bestemmelsesdug, det geolog

Nice tablecloth in color showing the geological cycle of the different types of rocks. Developed and illustrated by Benny Lindblad Johansen, associate professor of



Item: NL199110

Dino-Lite digital microscope, 1.

Quality 1.3 MP Digital Microscope / Macroscope, "handheld camera", with USB connection and adjustable lens with built-in adjustable LED

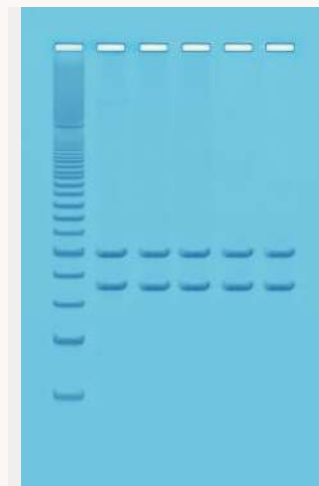

Item: 778332

PCR analysis of own mitochon

Kit 332. Students propagate two regions from their own mitochondrial DNA and then analyze them using DNA electrophoresis. Hair (preferably from eyebrows) or

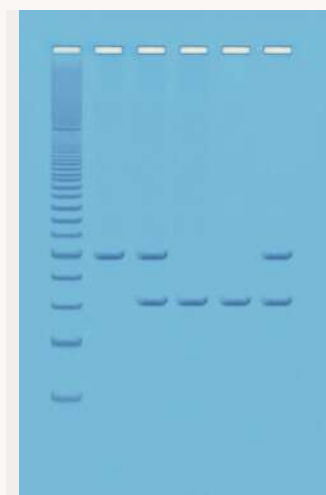

Item: 778333

PCR-based DNA-analysis of h

Kit 333. Students use primers for a 300 bp ALU insert in chromosome 16 (PV92) to determine their own genotype. Hair (preferably from eyebrows) or mouth

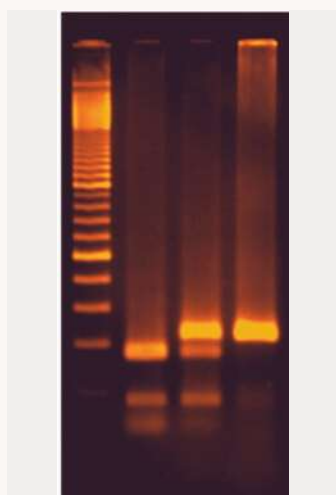

Item: 778345

Taste-no taste DNA test

Edvotek kit 345. Students test themselves for the taste-not-taste gene, which determines whether we can taste bitter. Students

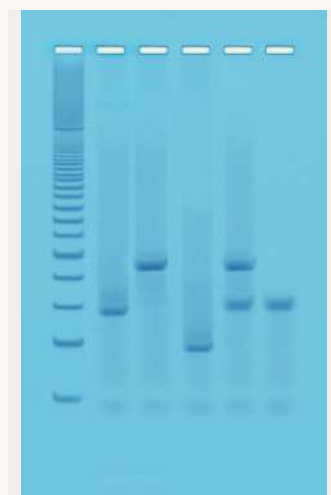

Item: 778371

PCR-based DNA Fingerprintin

Kit 371. Students solve a criminal case using PCR. DNA from a crime scene and from suspects is propagated in a PCR machine/water bath and subsequently analyzed



Item: 778372

PCR, Quick PCR

In this experiment, students gain an understanding of the traditional three-step polymerase chain reaction (PCR). Using PCR and agarose gel electrophoresis,



Item: 778851

The effect of alcohol on C. ele

OBS! Use within 2 weeks of receipt.
Students observe and document the effect of alcohol on the nematode *C.*



Item: 778956

Eco-toxicology: Oil-eating bact

Edvotek kit 956.
Students cultivate a mixture of oil-eating bacteria and observe their efficiency on different types of oil.

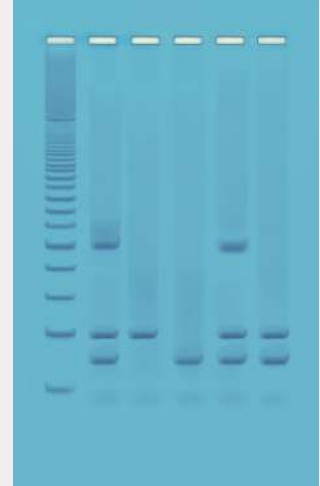

Item: 778962

PCR identification of GMO pro

Edvotek kit #962.
Students extract DNA from foods suspected of containing GMO products (e.g. tofu, cornflakes or soy products).



Item: 779215

Taste test control strips, tastel

Test paper without flavor.
Used together with 779210 Taste test PTC, which tests for bitter flavors.
By using the control paper,



Item: 779300

Flat-bottomed specimen tube

Preparation jar with flat bottom. 100 x 24 mm.



Item: 779302

Flat-bottomed tube stoppers i

Made of foam rubber.

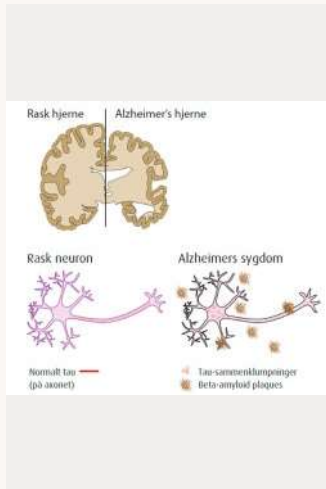

Item: 7781115

Alzheimer's Disease, Edvotek

Edvotek kit 1115. Detection of Alzheimer's risk factors using Western Blot Purpose: The purpose of this experiment is to familiarize students with and test western blotting.



Item: 774791

Magnetic model, organs, big

Magnetic model of the body's organs.
Fits the large body model (774790) where the organs can be attached as both parts

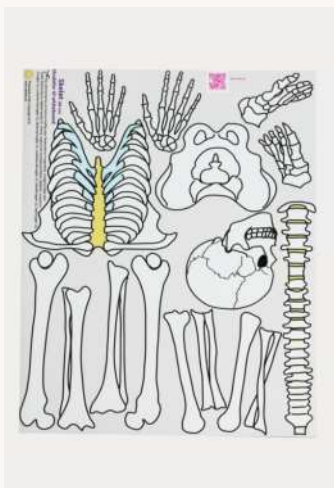

Item: 774797

Magnetic model, skeleton, sm

Magnetic model of the body's bones.
Fits the small body model (774795), where bones can be attached as both parts are



Item: 768101

Field spade, foldable

Practical folding trowel with steel blade and wooden shaft.
Folding dimensions: 15 x 48 cm (incl. shaft)
Blade dimensions: 16 x 21



Item: 890932

Winkler bottle, 100 mL

Glass Winkler bottle, 30 mL with NS 14/23 glass stopper.

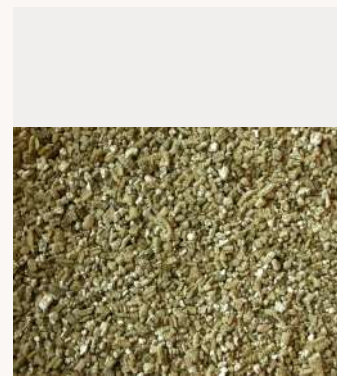

Item: 891278

Vermiculite 10 liter

Guaranteed nutrient-free culture medium for cultivation trials. Optimal for cultivation trials where the amount of nutrients must be varied between each



Item: 891280

Vermiculite, 100 L

Guaranteed nutrient-free culture medium for cultivation trials. Optimal for cultivation trials where the amount of nutrients must be varied between each

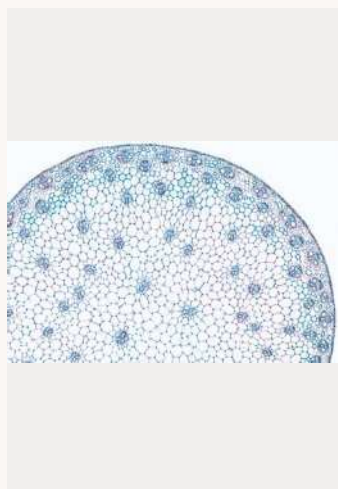

Item: NL218123

Prepared slide, monocot stem,

Stalk of a single-seeded plant, corn (Zea Mays) with scattered, closed, collateral vascular bundles. Transverse cut.

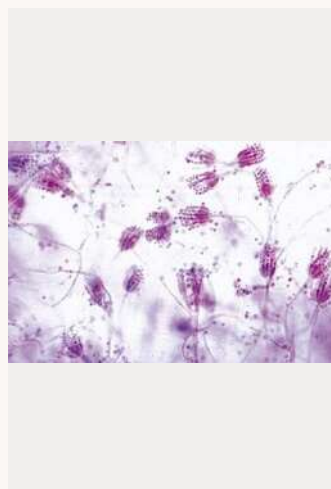

Item: NL219020

Prepared slide, Penicillium sp.,

Preparation Blue fungus, mycelium and spores total preparation.
Order from 10 pieces.
Note: Made to order,



Item: 774512

Animal cell, foam model

This over-cut soft foam model of an animal cell makes it easy to introduce the structure of the cell and its organelles to younger



Item: 774514

Animal cell, 3B

Divided model showing the shape and structure of a typical animal cell as it appears under the electron microscope.



Item: 763000

Flower pots, Ø9 cm, 18 pcs. pe

18 plastic flower pots for growing experiments
Diameter: 9 cm



Item: 763055

Mini greenhouse with heating

Robust mini greenhouse with heating mat (35 x 25 cm). With ventilation buttons in the lid. The heating mat can be controlled using an on/off timer (not included). With



Item: 763070

Mini greenhouse, model M, 28

Plastic, with clear lid. Opaque base with space for 28 cultivation briquettes (included)
Dimensions (L x W x H): 36 x



Item: 763085

Growing pellets

With cultivation hole for seeds or cuttings. The cultivation briquette absorbs water, making it a size suitable for mini greenhouses. The briquettes



Item: 763100

Plant press in wood

Table model with ash wood clamping roller and MDF clamping plates.
Ventilation holes in the clamping plates reduce the



Item: 763101

Blotting paper for plant press

Highly absorbent tracing paper that guides moisture away from the plants and ensures the fastest evaporation.



Item: 763103

Herbarium mounting paper

Strong, white quality. Suitable for mounting pressed plants and inserting into binders.
Format: A4, 100 sheets.



Item: 767001

Aquatic plant grapnel

For collecting aquatic plants and seaweed at greater depths than rubber boots allow. Drag with 6 bendable



Item: 767015

Water sampler

Professional water sampler made of heavy-duty plastic material and acrylic with stainless steel or brass metal parts to ensure durability and longevity. The product comes



Item: 767021

Line 10 m, braided nylon, 3 m

10 meter line for water sampler or plankton net. The line is made of braided white nylon, and mounted on a plastic handle that acts as a



Item: 767022

Line 20 m, Braided Nylon (3 m)

Made of braided nylon with high tensile strength. Length: 20 m, Thickness: 3 mm, Suitable for extending lines etc. Supplied on a plastic reel.



Item: 767027

Water sampler, without handle

With this smart water sampler it's quick and easy to take a water sample from a water surface, deep well or similar. It consists of a 1000 mL beaker (made of



Item: 767055

Secchi disc, black/white

Sighting disk (Secchi disk) for use in lakes etc. The sighting disk is made of plastic and has a black and white design on the upper side, while the underside is completely



Item: 767510

Earthworm viewing chamber, 2

To demonstrate earthworm life in the soil, including aeration, mixing of soil materials and decomposition of fallen plant material. Made of clear acrylic with 2



Item: 767702

Berlese apparatus

With stand, plastic funnel Ø22 cm and grate. For expelling small animals from soil samples. For example, take a



Item: 767704

Screen, Berlese apparatus, Ø2

For reading device.
Used in conjunction with the sieve that comes with our berlese apparatus. Place on top of the existing grate to



Item: 767930

Heat lamp with out bulb, Ø21 c

CE approved heat lamp with porcelain socket.
With 2.5 m cord, hanging chain and saving button.
For bulbs up to 175W.



Item: 767940

Heat lamp bulb, infrared, 150

Fits e.g. 767930 Heat lamp (E27), which is recommended for chicks after hatching in an incubator.
Specifications:



Item: 768001

Auger, professional model, 130

Professional model, consisting of a twist handle with approx. 60 cm rod and joint, in which an Edelmann drill tip is mounted. By pressing while turning the



Item: 768006

Gouge auger, broad opening

Soil auger made of rust-protected steel with an opening of almost 180 degrees so that the different layers of the soil sample can be easily examined.



Item: 760860

Net bag for daphnia net

Fits daphnia net type 760820. For replacement (i.e. without shaft and without ring). Mesh width: Approx. 70 micrometers.



Item: 774521

Animal cell, standard

The model shows the typical structure of an animal cell. It shows the cell membrane, cytoplasm, and a variety of organelles and structures.



Item: 774522

Plant cell, standard

Plant cell approximately 2000 times magnified, showing the typical structure of a plant cell and its organelles. The organelles are numbered



Item: 774552

Plant cell, 3B

Plant cell magnified 0.5 - 1 million times.
The model consists of two parts and shows the main structures of the plant cell



Item: 774562

Plant cell, foam model

This foam model of the plant cell makes it easy to introduce the structure of the cell and its organelles to younger students.



Item: 774700

Poster - Skeleton front and rear

Beautiful and colorful osteology poster with practical lamination, ready to hang up in the clinic or classroom. The poster shows and names all 206 bones in

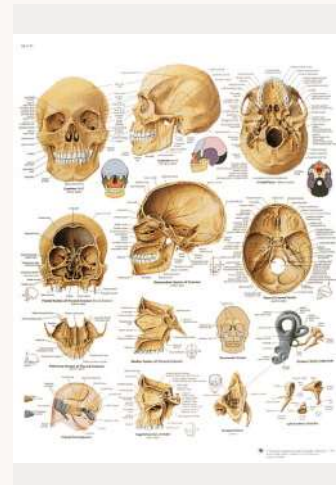

Item: 774710

Poster - The skull

Beautiful and colorful poster of the 29 bones of the human skull. Everything from lower jaw to ear bones are shown. The skull box is shown opened up so you can see



Item: 774725

Poster - The ear

Beautiful and colorful poster with practical lamination. English text.
Dimensions: 50 x 67 cm



Item: 775015

Dicot flower, model, Somso

Model of a two-petal flower approx. 10x magnified. The flower is cut through to reveal petals, ovary with style, stigma and stamens with anthers. One anther is cut



Item: NL210210

Prepared slide, heart muscle,

Heart muscle, human. Transverse and longitudinal sections. Transverse bands colored.
Heart muscle, human t.s. and



Item: 763010

Grow lamp, E27, LED

This growth lamp is ideal for demonstrating photosynthesis and respiration. With a very high color temperature, high output and full spectrum, this lamp is perfect for stimulating



Item: 309800

Food Coloring Set

Red, green, blue and yellow.
35 ml in total.



Item: 078114

Digital Camera, 5G WiFi, 5.0 M

This microscope camera is an upgraded version of the 078115 and replaces the 078115. It has a round robust metal body and much higher refresh rate and 5G



Item: 761040

Aquatic Net , bottom

Bottom net, with lightweight aluminum shaft, lightweight and practical, net with wide flat bottom edge of 30 cm. Good for catching benthic animals, as well as plant and



Item: 778043

Practice gel for electrophoresis

Practical for practicing proper pipetting technique without unnecessary consumption of agarose gels. Molded in soft plastic and



Item: 778044

Practice in micropipetting

Edvotek kit no. S-44 for micropipetting training. Provides both training in volume calculations in liters/microliters and practical practice in handling

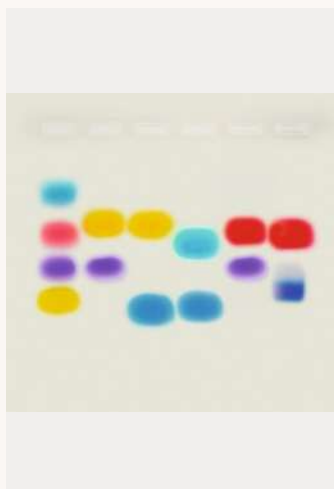

Item: 778049

In search of my father

The kit demonstrates in practice how genetic fingerprinting can be used to study relationships between individuals. Students use electrophoresis to find the



Item: 778051

Who has left DNA behind?

Simple experimental kit that demonstrates in practice how genetic fingerprinting is used in forensics. Students use agarose gel electrophoresis to solve a crime mystery by



Item: 778075

Do onions have DNA?

Edvotek Kit S-75. Students build DNA models and then extract and precipitate DNA from onions, strawberries or bananas (not



Item: 778091

Whose fingerprints were left b

Edvotek Kit S-91. Students solve a crime using fingerprint powder and fluorescent powder.

Materials 10 groups at high

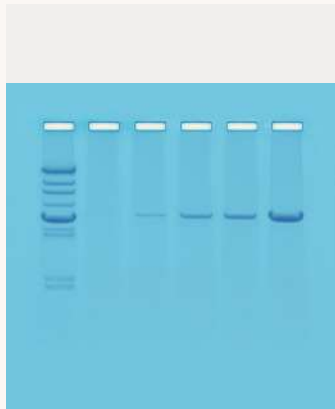

Item: 778103

Introduction to PCR

Illustrates the PCR principle without the use of a PCR machine! Students do not perform PCR themselves, but using electrophoresis, DNA that has already been



Item: 778108

Gel filtration chromatography

Edvotek kit #108. Students are introduced to column chromatography by separating dyes using a chromatography column

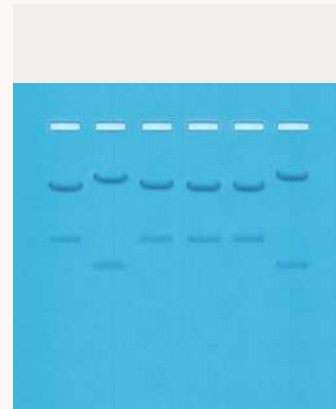

Item: 778109

DNA fingerprinting I

Edvotek kit #109. Students use DNA electrophoresis to solve a crime mystery by comparing DNA from a crime scene with DNA from suspects. DNA is already



Item: 778114

Paternity test Edvotek

Edvotek kit #114. Students use DNA Fingerprinting to solve a paternity case. DNA is simulated.

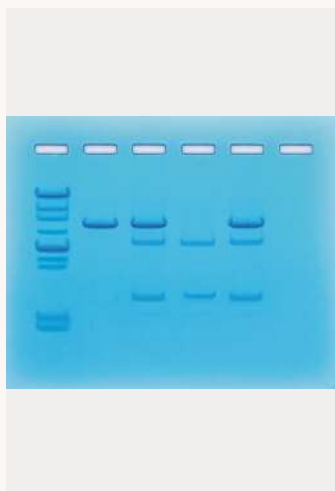

Item: 778115

In search of the cancer gene I

Students create a family tree for a family suspected of carrying the classic Li-Fraumeni syndrome (cancers caused by mutation of the p53 gene) and analyze the

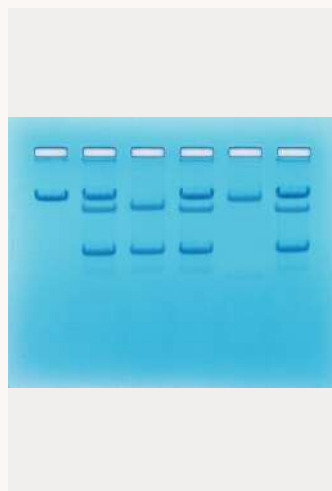

Item: 778116

Looking for sickle cell anaemi

Edvotek kit #116. Sickle cell anemia. Hereditary diseases in humans can be caused by a single mutation of a nucleotide. This change can alter the structure and thus

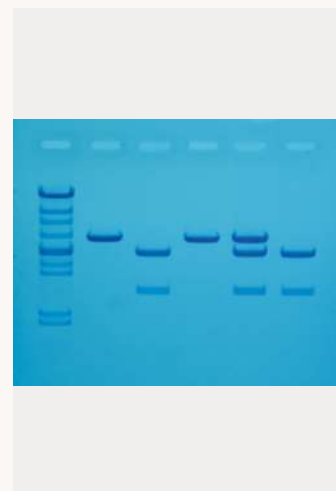

Item: 778118

Cholesterol diagnostics Edvot

Edvotek kit #118. Students test the parents from a hypothetical family for "Hereditary high blood cholesterol" (Familial hypercholesterolemia - FH).



Item: 778119

DNA necklace, own DNA

Edvotek Kit 119. Students extract and precipitate their own DNA. DNA can then be transferred to microcentrifuge tubes that



Item: 778120

DNA sequencing, ready-to-look

Edvotek kit no. 120. Students work with DNA sequencing using pre-sequenced DNA pieces (nucleotides A, C, G and T).

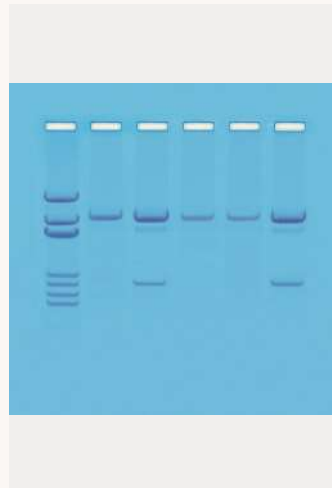

Item: 778121

Investigation of GMO, ready-to-look

Edvotek kit no. 121. Students analyze pre-processed DNA samples for the presence of GMO products. The samples are



Item: 767705

Funnel, for Berlese apparatus

Plastic funnel for Berleseapparatur, used for collecting e.g. soil organisms. The funnel is made of red plastic and has a diameter of



Item: 768008

Auger, length 110 cm

Ground drill in a very solid design. Diving length approx. 100 cm, with divisions every 10 cm. Total length: 110 cm



Item: 768501

Sieve set 6 pcs

6 plastic sieves with stainless steel mesh, lid and bottom collector. Complete with plastic lid and bottom collector



Item: 798003

Water Cycle model

The water cycle, low rainfall in the classroom. Simulation model consisting of a plastic tank with a sloping landscape of mountains,



Item: 302010

Lid for aquarium

Lid for 20 liter plastic aquarium (761525)



Item: NL210812

Prepared slide, spinal cord, hu

Spinal cord, human. Overview preparation. Transverse section.

Spinal cord, human, t.s. for general structure



Item: NL211055

Prep. Ho135e Compact bone,

Preparation of bone tissue, human. Compact bone, human, t.s. Note: Made to order. If the product is not in stock, the expected delivery time is 10-12 weeks.



Item: 781001

Organisms Freshwater, magne

Magnetic cut-out kits for building models of ecosystems. Use on whiteboard or other magnetic material.



Item: 760103

Shrimping net, large model

Hold the shrimp pole net in front of you in shallow water and walk slowly forward and you will catch something. A large shrimp pole net with a

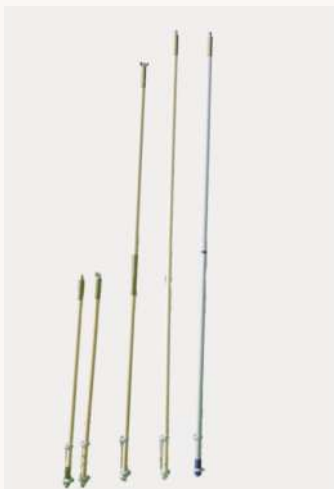

Item: 760620

Wooden handle, end section,

End shaft Type: modular mesh shaft

Material: wood

Length: approx. 95 cm



Item: 076729

Eyepiece Wide Field WF10x/18

Standard 10x microscope eyepiece with pointer. Can be used as an additional eyepiece for vertical tube on 077422 or 077151.



Item: 760624

Wooden handle, end section, 1

End shaft

Type: modular mesh shaft

Material: wood

Length: approx. 140 cm



Item: 760695

Net storage/net hanger

Practical hanger for 20-30 traps, nets or garden tools in 2 rows.

Made of galvanized steel and with a stop plate on the



Item: 760701

Line 15 m, with snaphook

15 meter line on spool.
The line has a thickness of 2 mm and is equipped with a carabiner with swivel.
Easy to mount on plankton



Item: 760800

Catch sieve, economy model,

Economy model with a solid stainless steel mesh frame with an interchangeable stainless steel sieve with a diameter of 20 cm.



Item: 7608001

Sieve, stainless steel, Ø20 cm

Stainless steel, for installation in catch sieve no. 760800 when replacement is required.
Diameter: 20 cm.



Item: 7608011

Sieve, stainless steel, Ø16 cm

Stainless steel, for mounting in catch sieve (760801) when replacement is required.
Diameter: 16 cm.



Item: 760808

Catch sieve, without crosspiec

For capturing and sifting benthic animals in streams. Diameter 20 cm. The heavily reinforced edge of the sieve ensures that it will never bend backwards during use. The



Item: 760818

Catch sieve, with crosspiece,

New improved version with reinforced welds, more robust version.
Same as no. 760808, but further reinforced with a cross



Item: 760820

Daphnia net, without handle

Consisting of a heavy-duty aluminum net hanger with a replaceable net bag made of extra durable plastic and a heavy-duty zinc-plated wing nut for mounting the net on



Item: 760822

Aquatic net, 1 mm, whitout han

Consisting of a strong aluminum net hanger, replaceable plastic net bag with reinforced edge and a strong zinc-plated wing nut for mounting the net on one



Item: 760830

Plankton net with collecting gl

For mounting on shaft.
Net ring made of aluminum.
Net bag made of durable and hard-wearing plastic. The bag is equipped with a removable



Item: 760874

Net bag for aquatic insects

Fits water insect net no. 760822 and 760900.
For replacement.
Net bag length: approx. 38 cm



Item: 760900

Aquatic net, 28 cm, with wood

Water net with strong aluminum frame. Net bag made of strong plastic with reinforced edge.
Due to the large net diameter,



Item: 760901

Dip net, 1 x 1 m

Consisting of 2 collapsible winch poles and a 1 x 1 m net. The net is lowered horizontally into the water and when a small fish, frog, etc. is above it, it is pulled



Item: 761050

Aquatic net with telescopic ha

Smart little water net with telescopic aluminum handle. Not quite as powerful as the larger water nets, but still a good alternative due to its price and flexible size. When



Item: 761155

Throwing rake, aquatic plant r

If you need to catch seaweed because you are inspired by the new Nordic cuisine or just want to see what seaweed species the local coast has to offer, this is an indispensable



Item: 761201

Sweep net

For capturing insects in vegetation. With heavy-duty aluminum net hanger. Net bag made of heavy canvas.
Net diameter: 35 cm



Item: 761252

Butterfly net, telescopic handl

Affordable butterfly net with large net bag.
Net diameter: 35 cm
Lightweight telescopic handle: 46-78 cm (fully



Item: 761255

Butterfly net

With collapsible sturdy lightweight 35 cm diameter net hanger. The net is made of soft, non-rotting plastic, Length: 75 cm



Item: 761260

Insect screen

For collecting insects and other small animals that live in withered leaves or on tree trunks. The insect screen has two



Item: 760869

Net bag for sweep net

For percussion net no. 761201. Replaces easily and without the use of tools.



Item: 761262

Insect Beating Tray

With handle and spill bars for collecting insects under bushes and trees. Solid construction with double-reinforced stitched



Item: 761400

River aquarium, 75 x 20 x 15 c

Lighter revised design. Current aquarium to demonstrate wildlife in running water. Using rocks, etc. to create



Item: 761410

Submersible circulating pump

Submersible pump for flow aquariums with adjustable speed 250-600 liters/hour. 220 volts. Powerful and stable aquarium



Item: 761501

Aquarium/terrarium, model s

With lid, liner and carrying handle. Dimensions: 17.5 x 11.5 x 13 cm Volume: 1.5 l



Item: 761502

Aquarium/terrarium, model m

With lid, liner and carry handle. Outer dimensions: 20 x 14 x 14 cm Volume: Approx. 2.6 L



Item: 761503

Aquarium/terrarium, model XL

With lid, liner and carrying handle. Dimensions: 34 x 20 x 22 cm Volume: 10 l



Item: 761504

Aquarium/terrarium, model lar

With lid, liner and carrying handle. Dimensions: 27 x 17 x 18 cm Volume: 6 L



Item: 761506

Aquarium/terrarium, model m

With lid and feed hatch - without carrying handle! Dimensions: 41 x 23 x 29 cm Volume: 20 l



Item: 761510

Aquarium, plastic, 2.5 L

Plastic aquarium without lid. Made of polystyrene. Glossy aquariums with sharp corners that reduce optical distortion. The top edge is



Item: 761520

Plastic aquarium, 6 L

6 L Plastic aquarium. Plastic aquarium without lid. Made of polystyrene. Glass clear aquariums with sharp corners that reduce



Item: 761525

Refraction vessel, large

20 l plastic aquarium Dimension 40 x 22 x 24 cm.



Item: 761550

Viewing chamber

For studying and photographing collected water insects. Made of Plexiglas with a rounded bottom so there are no corners where the water



Item: 761551

Bucket, clear, 5 L, no lid

Transparent plastic bucket that is an excellent alternative to the classic plastic containers as it holds more and can be transported more

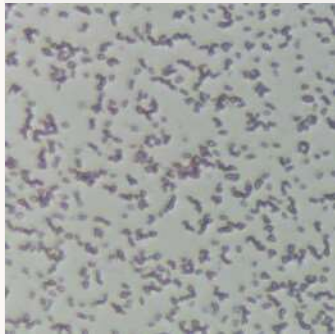

Item: 778160RF

Replenisher BactoBeads to kit

This is a refill kit for Edvotek kit 160 (778160). Bacteria. The kit contains only BactoBeads with bacterial cultures:

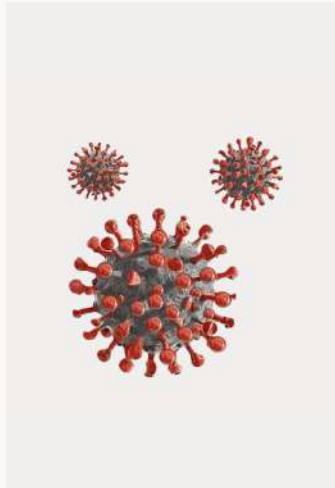

Item: 778263

Covid-19 test ELISA, Edvotek 2

COVID-19 Antibody Test, ELISA. Simulation test. Larger kit for 10 groups. Simulation of COVID-19 antibody test, via ELISA test.



Item: 778500

EDGE™ Integrated Electrophor

All you need is the new electrophoresis device and an Edvotek analysis kit. The built-in transilluminator makes the DNA bands visible and allows you to follow the



Item: 778540

EdvoCycler™ Jr. Personal PCR

Small compact PCR machine for only 16 tubes (0.2 ml PCR tubes). If you are new to the PCR technique or just don't need the large number of samples, this is the right



Item: NL212815

Prepared slide, tulip leaf epide

Preparation Tulip leaf epidermis with stomata and locking cells
Tulip, tulip, leaf epidermis with stomata and guard cells

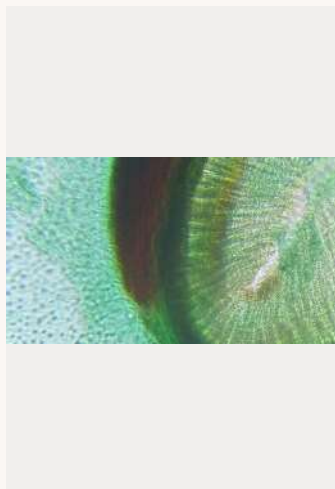

Item: NL213908

Prepared slide, spiracle (stigm

A preparation with a spiracle from an insect. The preparation shows a complete insect respiratory opening. The specimen is



Item: 800918

PCA agar, powder for 250 mL

For the cultivation of bacteria. Bag for 250 ml finished agar. This versatile PCA agar can be used for culturing most bacteria and some fungi. The



Item: 565884

Telescope binoculars 20-60 x

A very bright telescopic binocular with a large front lens of 80 mm. The perfect binoculars. Easy to handle and easy to focus.



Item: 076706

Adapter, Vertical Camera Tube

Adapter for the NeoX microscope, for mounting an extra eyepiece or smartphone adapter.

Ocular and/or smartphone



Item: 761552

Lid for clear bucket, 761551

Less lid (white plastic) that fits the clear plastic bucket 761551



Item: 761571

Air pump Tetrattec, 100 L/h

A good air pump with the option to adjust the air flow. Suitable for aquariums in sizes 80 - 150 L. The output is 100 L/h. Used together with aquarium/air hose (038512)



Item: 761576

Airstone, small pores, white

Air stone with small pores for aquarium tubing
Fits Tetrattec pumps
10 per package
Dimensions: 3 x 1.5 x 1.5 cm



Item: 761578

Air pump Tetrattec, 50 L/h

The smallest air pump with an output of 50 L/h, which makes it suitable for the smallest aquariums 30 - 60 l. Used together with aquarium/air hose item no.

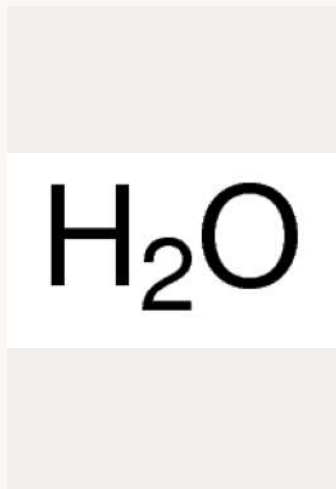

Item: 890300-5

Vand, demineraliseret

Synonym: Ion-exchanged water
Formula: H₂O



Item: 890300-6

Water, demineralised

Synonym: Ion-exchanged water
Formula: H₂O



Item: 541225

Oxygen meter OxyGuard Polar

A reliable oxygen meter is essential for accurate measurements of oxygen levels in both air and water. With this pocket-sized wireless electrochemical



Item: 078605-1

Immersionolie

Immersion oil for use between the sample and objective lens when using 100x objective. An immersion oil with low



Item: 077460

Microscope FS-1, Semi-plan, Tr

Trinocular microscope with LED light in an elegant design. The microscope is a good choice for teaching in primary schools as it is equipped with a 60x



Item: 768281

Geology field set

This kit contains most of the materials you need if you want to investigate different minerals and rocks. The kit contains:



Item: 798002

Water Stream Table kit

Demonstration kit for visualizing the creation of a watercourse and its course with erosion and sedimentation.



Item: 784061

Lung Volume Bag kit

A kit for lung capacity testing. The kit consists of four bags with holder. The bags are made of durable plastic and silk-screened with



Item: 774010

Female genital organs, median

Cross-section of the female pelvic bartia consisting of two parts. The model shows important anatomical structures of the pelvis, including the uterus, ovaries,



Item: 774070

Chick Life Cycle Exploration S

Follow the chick's development day by day inside the egg with this set of 21 eggs. The eggs can be opened and contain realistic illustrations of a chick's



Item: 774201

Foetal development, 9 stages

The model consists of 9 parts showing:

- Fetalization
- Fetal at 6 days
- Fetal at 1 month



Item: 774202

Female genital organ, model

Cross section of the female pelvic bartia. The model shows important anatomical structures of the pelvis, including the uterus, ovaries, fallopian tubes, fallopian tube



Item: 774203

Male genital organ, model

Cross section of the male pelvic bartia. The model shows important anatomical structures in the pelvis, including testicles, epididymis, spermatic cord

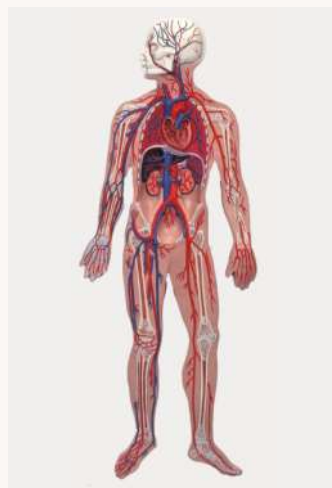

Item: 773530

Blood circulation, relief model

Relief model in 1/2 life size. Provides a schematic representation of the blood vessel system with arteries and veins and the blood supply to the different organs.



Item: 768161

Towel, narrow

Fiskars planting spoon, narrow
Lightweight, robust model ideal for children
The planting spoon is



Item: 768162

Trowel, wide

Fiskars planting spade, wide
Lightweight, robust model.
Universal tool for all small digging and planting tasks.
Glass fiber reinforced



Item: 768025

Rock collection, oil rocks

Set of 7 rocks that are important for the oil industry in Norway and elsewhere. It contains source rock, reservoir rock and "roof rock (seglet)".



Item: 768027

Rock collection, rocks/mineral

Stone collection with four important rocks and four minerals that are part of them.
Rocks: Sandstone, limestone,



Item: 768030

Rock collection, metamorphic

24 different metamorphic rocks, including different types of marble, slate and gneiss.
Delivered in a beautiful



Item: 768031

Rock collection, sedimentary r

24 different sedimentary rocks, including various types of sandstone, shale and limestone.

Delivered in wooden box,



Item: 768032

Rock collection, igneous rocks

24 different igneous rocks. Supplied in a wooden box, Danish instructions available on this page.

Contents:



Item: 780451

Finger pulse oximeter

Measures oxygen saturation, fingertip pulse and respiratory rate using an infrared sensor

Incredibly easy to use 1.

Turn the device on by



Item: 883300-3

Sand for Chladni plates, 400 g

Quartz sand. Grain size: 0.4-0.8 mm



Item: 768048

Hardness scale, Mohs

Small stone collection with 10 different stones with different hardness according to Mohs classification (hardness 1-10). It is therefore possible to determine the hardness of



Item: 052036

Sorting Tray, mini, 12 pcs.

Small white sorting trays made of impact-resistant plastic (CPET). 12 pieces per package.

The tray is good for storing



Item: 781070

Identification chart, Stones in

Educational and visually appealing identification tablecloth for stones found in the Danish landscape. The tablecloth can be used for all grade levels and higher



Item: 050601

Drigalski spatulas, stainless st

Stainless steel Drigal spatula Length: 165 mm Spatula width: 40 mm



Item: 888770

TAE buffer, 50x conc. Edvotek

500 mL 50x concentrated buffer.
Gives 25 L of finished electrophoresis buffer.

[Examples of mixing ratios](#)



Item: 768163

Seed trowel, narrow

Slim planting spoon with a metal shovel head and a handle in plastic material.
Length: 32 cm
Width: 5.5 cm



Item: 142900

Gun Clinometer

This simple protractor made of impact-resistant plastic allows you to measure heights of distant objects such as houses, trees and towers or the physical



Item: 078210

10.5" LCD Pad Camera, for mic

This is the successor to the 078200. 10.5" LCD touchscreen with integrated 4K digital camera for microscopes. Can be placed in a camera tube and capture



Item: 048601

Inoculating loops, single use, 1

Solid disposable plastic pointer needle
Eye size: 10 µL Total length: 200 mm
Number: 48 pcs per package



Item: 055882

Collecting Glass, 120 mL

Brown tinted glass with black bakelite screw cap with inlaid gasket. Used for storing plankton samples, among other things.



Item: 780050

Safety blood lancet, pink 2,4 m

100 easy-to-use safety finger prickers similar to the type found in the popular Eldon card sets (780015). The safety lancing device is used to puncture the skin to collect



Item: 767070

Turbidity tube - 60 cm

The tube is used to accurately measure the turbidity (cloudiness) of water from shallow or flowing water bodies where a sieve disc cannot be

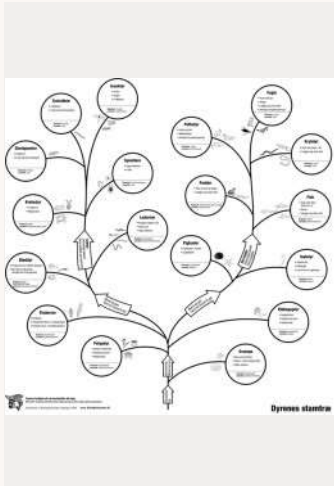

Item: 768066

Evolution chart, the animal fam

The Evolution Canvas, the animal family tree, provides an overview of the different animal groups, based on the relationship between the groups.



Item: 768070

Fossil set, 8 fossils

An exciting set with important groups of fossils, Nordic and foreign.

It contains trilobite, tooth from an extinct shark, sea lily,

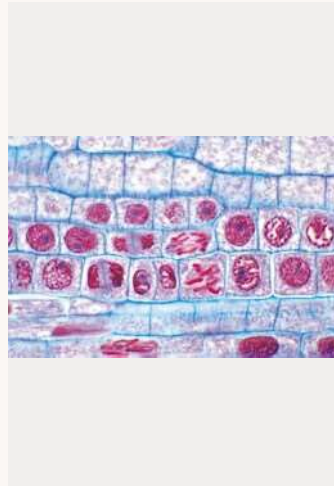

Item: 079166

Microslide, DNA in nucleus

To illustrate all plant stages of mitosis

Micro preparation of cell division in onion/root

Staining method: quadruple



Item: 076715

Darkfield slide, simple, NeoLab

The darkfield slide is easily pushed into the condenser of the NeoLab or NeoX microscope to achieve good contrast in the colorless object.



Item: 768152

Field spade, folds into 3

Handy folding model that takes up so little space that it fits in a small bag. Both blade and handle are made of steel.



Item: 768160

Trowel, painted, wide

All-purpose heavy-duty garden model.

Length: 32 cm

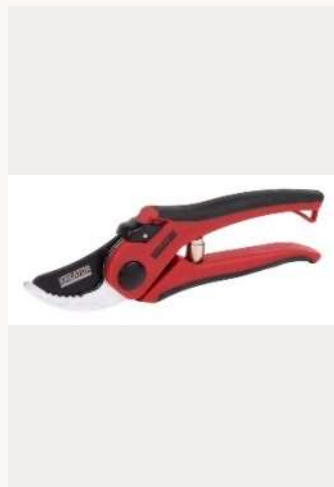

Item: 768213

Secateurs

With eagle beak and solid anatomical handle.

Teflon blade top, blade bottom chrome-plated Soft coating on handle, Handle PP



Item: 768270

Geologist's hammer, pointed

With a head that is flat at one end and pointed at the other.

Professional model forged in one piece in an excellent steel quality.



Item: 782031

Glucometer Contour NEXT

The model has the same accuracy as the previous version +/- 20% to +/- 10%.
Measurement range: 0.6 mmol/L –33.3 mmol/L glucose



Item: 781002

Organism Sea Water, magneti

Magnetic cut-out kits for building models of ecosystems. Use on whiteboard or other magnetic material.



Item: 781003

Organism from the Land, mag

Magnetic cut-out kits for building models of ecosystems. Use on whiteboard or other magnetic material.



Item: 797025

Water filter, Sawyer, MINI kit

New water filter for water purification experiments or field trips.
With the Sawyer MINI water filter you have the ability to



Item: 544400

Light box, white light, 25 x 25

Practical light plate with a full 25 x 25 cm observation area. Lit by LED and therefore has a very long lifetime. Very useful for visualizing



Item: 778001

Glo Germ Powder, fluorescens

Used to demonstrate the spread of "bacteria" and "viruses", such as the corona virus.
Dry the powder on a critical

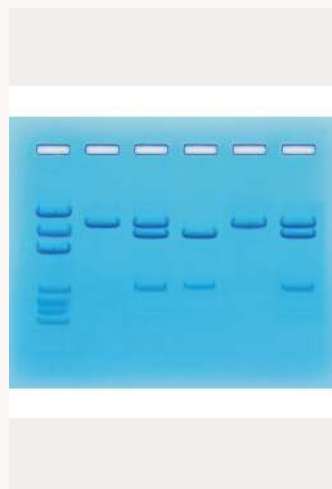

Item: 778123

COVID-19 test, RT-PCR, Edvote

Edvotek kit 123. COVID-19, coronavirus, caused by SARS-CoV-2 coronavirus. This simulated test uses electrophoresis to detect the presence of SARS-CoV-2



Item: 768310

Clipboard

It's important to be able to take notes, both in class and on the field trip.
Double writing pad so the paper doesn't get wet if



Item: 768340

Carry case, with lid, type 120

Type 120 with hinged lid. Made of 6.5 mm birch plywood with 4 mm lid. Fitted with a suitcase handle in both ends.



Item: 768343

Carry case, field box

Made of impact-resistant plastic. Compartmentalized and with handles. Stackable. Size: approx. 37 x 28 x 11 cm.



Item: 768410

Repair set for waders

Consisting of special glue and patches.



Item: 768438

Waders size 38, junior

Consisting of plastic-coated polyester trousers with welded-on non-slip plastic boots and 2 shoulder straps. The pants reach to the



Item: 768439

Waders size 39

Consisting of plastic-coated polyester trousers with welded-on non-slip plastic boots and 2 shoulder straps. The pants reach to the



Item: 768440

Waders size 40

Consisting of plastic-coated polyester trousers with welded-on non-slip plastic boots and 2 shoulder straps. The pants reach to the



Item: 768441

Waders size 41

Consisting of plastic-coated polyester trousers with welded-on non-slip plastic boots and 2 shoulder straps. The pants reach to the



Item: 768442

Waders size 42

Consisting of plastic-coated polyester trousers with welded-on non-slip plastic boots and 2 shoulder straps. The pants reach to the



Item: 768443

Waders size 43

Consisting of plastic-coated polyester trousers with welded-on non-slip plastic boots and 2 shoulder straps. The pants reach to the



Item: 768444

Waders size 44

Consisting of plastic-coated polyester trousers with welded-on non-slip plastic boots and 2 shoulder straps. The pants reach to the



Item: 768445

Waders size 45

Consisting of plastic-coated polyester trousers with welded-on non-slip plastic boots and 2 shoulder straps. The pants reach to the



Item: 768446

Waders size 46

Consisting of plastic-coated polyester trousers with welded-on non-slip plastic boots and 2 shoulder straps. The pants reach to the



Item: 078858

Microscope slide set, artery a

Get a complete set of 25 identical micro slides showing cross sections of an artery and vein. The microscope slides can be used as reference material to help



Item: 078859

Mikropræparatsæt, menneske

Discover the world of blood cells with our exclusive microscope slide set for blood slides! This set includes 25 human blood slides, each drop of which is a fascinating



Item: 078860

Microscope slide set, sperm c

Explore sperm cells with this micro-prep kit, designed to explore and study sperm cells in detail. With 25 identical preparations of colored sperm cells, this kit allows you to



Item: 781021

Identification chart, Plants from

Take the tablecloth into nature when the class investigates a waterhole. The tablecloth provides quick answers to what



Item: 768502

Soil sieve set, 9 sieves, alumi

Solid design in aluminum, consisting of 9 sieves, lid and base.

Sieve mesh: Made of stainless steel



Item: 768503

Soil sieve set, 3 sieves

Sieve set in stainless steel, with large diameter sieves and mesh sizes according to Danish standards. Solid stainless steel construction, consisting of 3 sieves, lid and



Item: 768560

Soil permeability tube

Investigate the porosity of different soil samples. Fill the tube with different soil samples and pour the same amount of water into them.



Item: 768600

Raunkjær's circle

Iron ring with an area of 1/10 m².

Laid out randomly in a field, meadow, forest floor or similar where you want to



Item: 769500

Bathyscope, large

Large funnel-shaped model with round tempered glass window and soft anatomically shaped rubber cuff against the face. The binoculars split easily into 3 parts, so they



Item: 048550

Cotton applicators, sterile, 150

Sterile wooden swabs with cotton wool. Packed in bags, 2 pcs. in sterile packaging Length: 150 mm



Item: 048605

Inoculating loop, nichrome ey

Nicrom grafting needle, 7 cm with 20 cm aluminum shaft



Item: 048613

Inoculating loops, single use, 1

Soft and flexible swab needle. Sterile packaged. Eye size: 1 µL



Item: 050610

Drigalski spatula, glass, 45/14

Digallic glass spatula
Diameter: 5 mm Spatula
width: 45 mm Total length:
145 mm



Item: 050620

Drigalski spatula, plastic, steril

Plastic triple spatula. Packed
sterile.
Spatula width 40 mm, length
150 mm.



Item: 052030

Sorting Tray, 35 x 27 cm

This black ring tray is a handy
multi-purpose tool and is easy
to carry both in the classroom
and on field trips. It is made of
durable, impact-resistant
plastic and has a flat



Item: 767541

Insect collector

Consisting of a collection jar
with stopper and two hose
pieces. For gentle collection
of small insects from soil,
leaves, etc.



Item: 052033

Sorting Tray, 49 x 30 x 9 cm

Plastic tray produced in white
impact-resistant polyethylene
(LD-PE) with flat bottom and
carrying handle. The tray is
approved for storing minced
meat, raw meat and other



Item: 052037

Sorting Tray, 70 x 45 x 18 cm

Plastic tray produced in white
impact-resistant polyethylene
(LD-PE) with flat bottom and
carrying handle. The tray is
approved for storing minced
meat, raw meat and other



Item: 055970

Sample cup, PP, 60 mL, screw

Pipes for collecting or storing
various materials or for sterile
cultivation of plant cultures.
Clear plastic jar with red
screw cap.

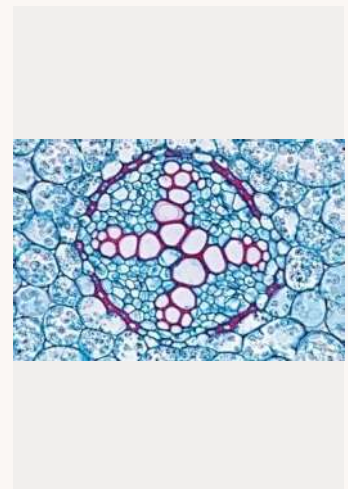

Item: 079215

Slide Ranunculus, buttercup, d

Single preparation
Order from 10 pieces. Note:
Made to order, expected
delivery time 10-12 weeks.
Color and shape of ordered



Item: 781037

Dissection sheet, blue mussel

This clever mussel dissection cloth measures 60 x 73 cm and is ideal for teaching when dissecting mussels with your students – maybe even as part of [outdoor school](#)?



Item: 763082

Mini greenhouse, model XS, 6

Plastic, with clear lid. Opaque base with space for 6 cultivation briquettes (included)
Dimensions (L x W x H): 16 x



Item: 778728

BactoBeads E. coli GFP Host

Includes: 5 beads Storage: Dried out in the fridge
BactoBeads bacterial cultures have a minimum shelf life of 6 months, but in practice can



Item: 768511

Kitchen sieve, 20 cm

Water screen - diameter 20 cm.



Item: 769501

Bathyscope, small

With square window of clear plastic and soft, anatomically shaped cuff against the face.
Window size: 20 x 17 cm,
Length: Approx. 40 cm



Item: 769520

Sediment sampler

For picking up bottom deposits in soft bottoms.
Clear acrylic tube, 30x500 mm, with a sharp edge at the end to be inserted into the



Item: 770013

Eye in bony orbit, 7 parts

Divided into 7 parts:
- Eye socket with eye muscles
- Retina in 2 halves with cornea and eye muscles (



Item: 770015

Eye, 6 parts, 3x enlarged

Dividable into 6 parts:
- Retina in 2 halves with cornea and eye muscles (outer part, white)
- Retina in 2 halves with iris



Item: 770110

Ear, 3 parts

Dividable into 3 parts, approx. 3x magnified.
With removable eardrum with hammer, anvil plus stirrup and snail with balance organ.



Item: 771016

Brain, 4 part, detailed

High quality model of the human brain that can be divided in half to show the two hemispheres, midbrain, Corpus callosum, brain stem, Medulla oblongata and

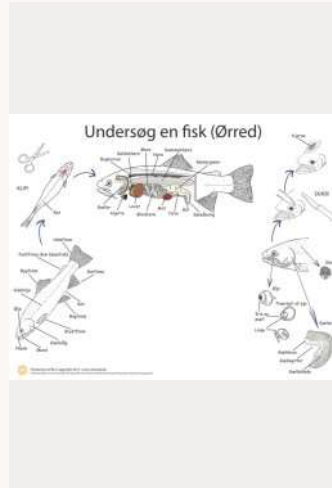

Item: 781036

Dissection sheet, Fish

Smart dissection cloth for use when dissecting fish such as trout.
Dissections of the different parts of the fish are depicted



Item: 704244

Knife, standard

A fine quality knife (dagger) at a very reasonable price. The knife has a stainless steel blade and non-slip grip.
With finger guard and plastic



Item: 062102

Thermometer, digital

Digital pocket thermometer with measuring range -50 to 300 °C (-58 to 572 °F) with 0.1 degree resolution.
Absolute accuracy: 1 °C (1 °F)



Item: 014410

Capp Starter Set, 2-20, 20-20

Practical starter kit with 3 different Capp Bravo pipettes, 3 boxes of pipette tips, digital stopwatch and pipette stand with space for 5 pipettes.



Item: 771018

Brain, foam model, life size

Simple foam model of the brain to help students understand the complexity of the brain.
The model can be split in two



Item: 077423

Microscope FS-1, monocular,

The popular FS-1 microscope is now also available with battery. This makes the microscope ideal for taking into the field. Can also be used with a regular power



Item: 076705

Phase Contrast objektive PH P

Phase contrast objective PH Plan 40x negative. The phase contrast objective only works with a phase contrast sled and a centering



Item: 771750

Skull: Sinanthropus

Homo erectus pekinensis (Sinanthropus pekinensis) - 'the upright man'. A member of the Homo erectus branch of the Homo



Item: 771751

Skull: Neanderthal

The skull of Homo sapiens neanderthalensis - the close relative of Homo sapiens sapiens. The skull is a replica of a skull



Item: 771752

Skull: Cro Magnon

Skull of Cro Magnon man. Cro Magnon means 'the great cave' and refers to the cave in Les Eyzies in France where five skeletons of Homo sapiens sapiens were found



Item: 771753

Skull: Ancestor of Neanderthal

Reconstruction of a skull found in a gravel pit in Steinheim in southern Germany in 1933. The fossil, which bears



Item: 771754

Skull: Rhodesian (Broken Hill)

Copy of a Homo erectus rhodesiensis skull found at the Broken Hill mine in Northern Rhodesia in 1921. The skull is one of the most



Item: 771755

Skull: Boisei (KNM-ER 406)

This skull is a replica of a skull found in East Africa in 1959 belonging to Australopithecus boisei or Paranthropus boisei - one of the early hominids. The



Item: 771760

Skull: Chimpanzee

Copy of the skull of Pan troglodytes. The skull is a cast of a female chimpanzee skull. Together with the orangutan and gorilla, chimpanzees are the large



Item: 772010

Skeleton, Stan, 170 cm

Life-size skeleton in high casting quality from 3B. Anatomical details are reproduced very lifelike - for example, the skeleton contains 200 bones and has



Item: 7720102

Base for skeleton, 5 wheels

Without metal rod for skeleton attachment.
Made of plastic.



Item: 772016

Skeleton, standard, 168 cm

Skeleton is smaller than life size, in ok casting quality from Ningbo Kelsun

Anatomical details are not



Item: 772017

Skeleton with muscle origins a

Skeleton is smaller than life size, in ok casting quality from Ningbo Kelsun

Anatomical details are not quite sharp and some of the



Item: 772020

Cranium: Human, homo sapien

A life-size cast of a premium human skull (Homo sapiens sapiens).

Anatomical details are reproduced very lifelike with



Item: 772082

Knee joint with ligaments

Functional model. Shows the position of the ligaments and the changes in them with different movements.



Item: 772530

Teeth, demonstration model

Foam model of teeth and mouth.

Works as a hand puppet and is great for demonstrating oral and dental hygiene.

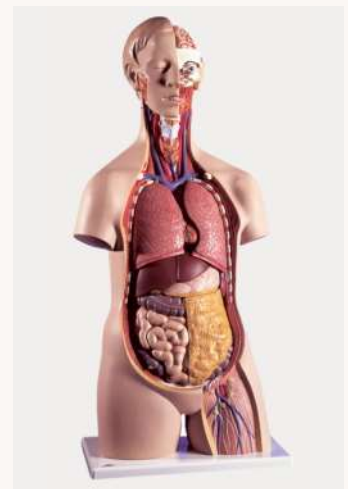

Item: 773013

Torso, unisex, 14 parts

The torso has 14 removable parts:

Head with exposed brain and skull

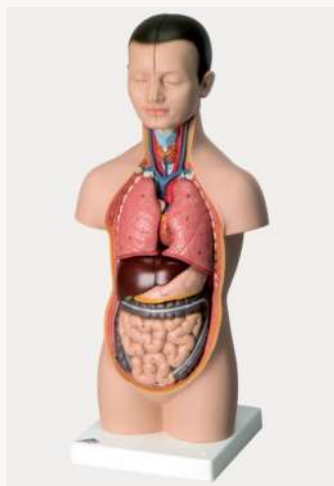

Item: 773022

Torso mini, with removable he

Half-size torso with 12 removable parts - great for communicating the body's organs and structure. This economical torso is similar in its reproduction of details to



Item: 773025

Torso, unisex with open back

Classic 84 cm full-size torso in nice quality. The torso consists of 17 removable parts, all with good detail and lifelike colors. The torso allows you to see the



Item: 773035

Torso, dual sex

Luxurious life-size torso with interchangeable female and male genitals. Ideal for teaching anatomy, physiology and medicine.



Item: 773400

Heart, 3 parts

The heart is 3-4 times larger than a normal heart and can be divided into three: the atria and vascular trunk can be removed and the two chambers can be opened



Item: 773410

Heart on stand, 2 parts

Life-size model of the heart. The heart is mounted on a stand that can be removed and divided into 2. The model has clear veins, arteries and heart muscles and has many



Item: 773413

Heart, 5 part, 2x enlarge

Luxury model of the heart in 2x magnification. The heart is mounted on a removable base and consists of 5 parts. The heart's vascular trunks and the part of the esophagus



Item: 773528

Lung function model

This special and very user-friendly lung model shows in a very clear way what happens when we breathe in and out.



Item: 076724

Phase contrast set for NeoX a

A complete phase contrast set that allows you to see even the smallest cells without prior staining. The phase contrast lenses



Item: 078634

Lens and LCD cleaning set – b

Lens and LCD cleaning kit for easy cleaning. Suitable for lenses and LCD screens. Clean easily and quickly. Use cleaning fluid: Wipe off dirt first as usual Pour the

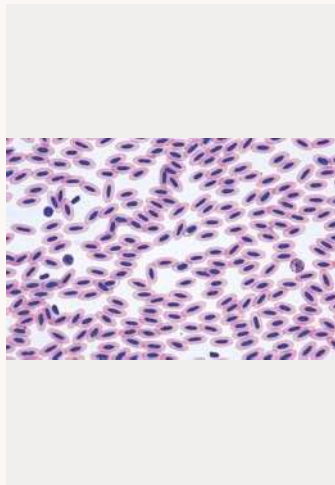

Item: 079235

Slide chicken, blood smear

Gallus domesticus. Johannes Lieder Micropreparation for chicken blood smear is of high quality and is manufactured with great care.



Item: 067412

Centrifuge tube, PS, conical Ø

Polystyrene (PS) centrifuge tube, 12 ml, graduated, sterile, with screw cap and conical bottom. Fits centrifuge 067900, for

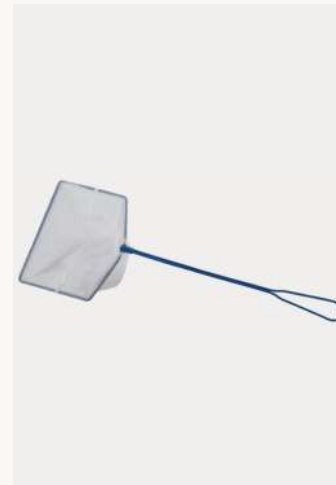

Item: 761433

Aquarium net ,15 cm wide

Aquarium net, 15 cm wide, mesh size approx. 1 mm Used for larger aquariums or small fish ponds. Dimensions: 15 x 12



Item: 782521

Urine stick, Glucose + Protein,

Test strips for protein and glucose (sugar) detection in urine.

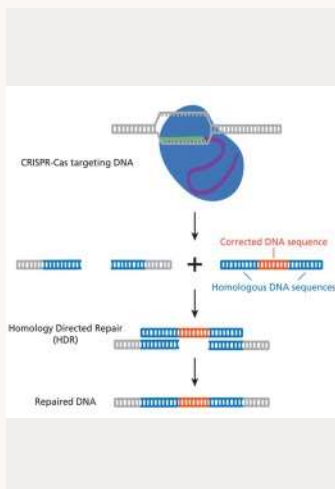

Item: 778135

Brug af CRISPR til behandling

Edvotek kit 135. Using the CRISPR method to treat cystic fibrosis In this experiment, the CRISPR-Cas9 method is



Item: 598301

Lærervejledning til Vind og Ve

Extra teacher's guide for the "Wind & Weather" subject case. 28 pages in Danish.



Item: 598302

Elevhæfte til Vind og Vejr

Extra workbook for the "Wind & Weather" theme case. 16 pages in Danish.

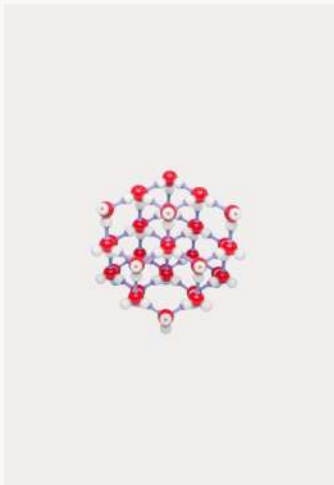

Item: 527578

Ice

Molecular model of "Ice". Contains 105 atomic spheres and 130 links and comes unassembled but with assembly instructions.



Item: 544124

Electrophoresis power supply,

Digital power supply from Edvotek for both DNA and protein electrophoresis. Can run all combinations of DNA and protein electrophoresis (vertical), but only 2 M36



Item: 544150

Electrophoresis apparatus, hor

Edvotek electrophoresis machine with 6 gel chambers. M36 has a platinum electrode on each side and safety lid equipped with safety cables.



Item: 534000

Periodisk system, A4, dansk

[The Periodic Table of the Elements](#) is specially designed as an aid in chemistry teaching. The Periodic Table of the

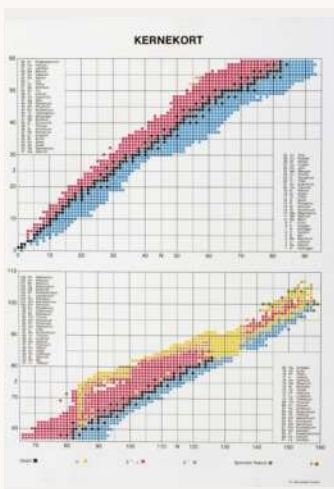

Item: 536000

Isotoptavle, A4, dansk

The isotope chart is also called the nuclide and nucleus map. One side of the isotope chart shows the most common



Item: 544155

Electrophoresis apparatus hori

Flexible electrophoresis device for horizontal (DNA) electrophoresis. Includes 1 x 7 x 14 cm gel tray for use when separating

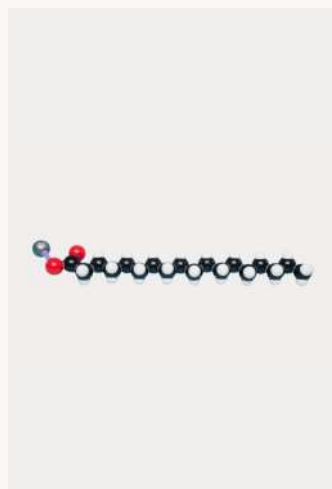

Item: 527548

Model, soap

Molecular model of "Soap". Contains 56 atomic spheres and 57 links and comes unassembled but with assembly instructions.



Item: 527551

Model, fat

Molecular model of "Fat". Contains 173 atomic spheres and 175 links and comes unassembled but with assembly instructions.



Item: 541251

Flow meter, PC

Compact current speed meter with the option to transfer to computer (CSV file)

New version, now also with built-in temperature sensor



Item: 544122

Electrophoresis power supply

The popular electrophoresis power supply has been updated and upgraded and includes a built-in timer! Results can be read in just 20-30



Item: 598300

Wind and weather, CVK case

This case contains a mobile weather station with everything needed to systematically measure and observe wind and weather. With the equipment and



Item: 061006

Field thermometer

Small plastic thermometer with pocket clip. A good field trip thermometer that quickly sets itself to the correct temperature. The thermometer can withstand



Item: 061515

Soil thermometer, mini

Small simple thermometer with spear. Comes with holster.

Measuring range: -10 to +110 °C



Item: 061520

Soil thermometer, 20 cm

Soil thermometer, length 20 cm, bimetal, extra solid. Measuring range: -20 °C - +60 °C



Item: 061530

Soil thermometer, 30 cm

Handy little soil thermometer with easy to read dial.

The thermometer is inserted into the ground



Item: 061550

Soil thermometer, 50 cm

Soil thermometer 50 cm, Bimetal, extra solid (Karpen: nickel-plated steel plate). Measuring range: -20°C - +60°C



Item: 340010

Compass, transparent, set of 1

For demonstration of magnetic field lines.
Dimension : Ø 21,5mm
Dimension : Ø 21,5mm



Item: 340505

Pocket compass with ring, Ø4

Diameter: 40 mm



Item: 340512

Compass, student model

Classic compass with 360° scale and ruler.
For orienteering we recommend Silva compasses.



Item: 340517

Compass, Silva Field

The classic compass in a slightly updated design and in the well-known good quality from Silva. Like Silva Ranger (3405.15), but without magnifier. 360°



Item: 340518

Compass case with foam inlay

Foam-lined case for storing and transporting up to 28 map compasses.
Compasses are not included.
Fits Silva Field (340517) and



Item: 271205

Introduction to thin layer chro

Students use color chromatography to investigate different water-soluble pens.
For further analysis, students



Item: 649855

Air pump Eheim 3704, 400 l/h

Quality pump from Eheim with a high output of 400 L/h distributed over two outflow nozzles. Comes complete with pump, hose and 2 outflow



Item: 757544

Formicarium

Take the ants into the classroom and see how they live.
An educational tool to demonstrate how ants live.



Item: 757545

Refill for formicarium

Bag with finished gel for ant nest 250444. Place the bag in boiling water for about 5 minutes until the gel has melted and after 5-10 minutes of cooling, carefully pour it



Item: 760102

Shrimping net, fine-meshed

Hold the shrimp net in front of you in shallow water and walk slowly forward and you'll catch something.

This newly developed model



Item: 704240

Knife, Mora

High quality knife from Swedish Mora.

With finger guard and sheath. Blade in high-quality stainless steel to maintain sharpness.



Item: 670137

Counting chamber with ruling

Used for both physics and biology/biotech. Plastic plate with 10 counting chambers with an engraved counting square in each chamber.



Item: 544162

Gel tray for M6Plus, 7 x 10 cm

Fits Edvotek M6+



Item: 544170

Electrophoresis apparatus, ver

Redesignet protein elektroforeseapparat fra Edvotek med platinelektroder. Kan køslash;re 1 stk. 9 x 10 cm polyacrylamid gel (vare nr. 790650)



Item: 544200

PCR machine EdvoCycler tube

Simple, easy-to-use PCR machine made especially for educational use.

Space for 48 PCR tubes of 0.2 ml.



Item: 526300

Atom model, vibrating

Molecular model whose connections consist of strong feathery to show that molecules are only static at 0 K. Does not represent a specific substance, only



Item: 544450

Transilluminator, Blue and Whi

Transilluminator with large field of view and both blue and white light.

- Large platform: 17 x 27.5 x 1.5 cm
- Dual light



Item: 545900

Hand-held Refractometer, 0 -

Handheld refractometer for measuring sugar content between 0 and 32%.

For measuring or determining the concentration and mixing



Item: 545910

Hand-held Refractometer 0-8

Handheld refractometer for measuring sugar content 0-80% (liquid honey)

Scale division: 0.5%
Length / diameter: 155 mm /



Item: 545913

Refractometer, salinity

This saltwater refractometer is a high-quality instrument specifically designed to accurately measure the salt concentration in seawater. With the automatic



Item: 545916

Salinometer with suction bulb

Salinometer - with built-in scale to read the salt content in g/l.

The meter, which is specially developed for the aquaculture



Item: 560000

Planetarium, Helios

The planetarium is a mechanical model of the solar system.

Outside the sun, Mercury, Venus, Earth, Mars, Jupiter



Item: 560030

Planetarium, mini model

To demonstrate our solar system, the movements of the planets and the Moon and the direction of their orbits.

The planets are mounted on



Item: 561020

Tellurium N

Robust and movable model of the sun/earth/moon system, equipped with light and collection lens that allows the device to be used in class without dimming the lighting.



Item: 561030

Tellurium, illuminated

This demonstration model shows the rotation of the Earth and Moon around the Sun, properly geared to show their positions month by month.



Item: 527564

DNA model, 12 layers

Small model of DNA double helix. The model consists of 6 parts, each with its own color. The parts are made up of the bases: thymine, adenine, guanine and cytosine, while



Item: 527565

DNA model, 22 layers

This DNA model makes it easier to study the double helix structure. The model contains 22 base pairs consisting of:



Item: 527566

RNA-model

An RNA model makes it easier to study the structure. The model contains 12 bases: 3 thymine (T), 3 adenine (A), 3 guanine (G) and 3 cytosine (C) in different



Item: 527570

Protein synthesis, constructio

The protein synthesis kit contains the following parts: 6 Uracil (U) 6 Adenine (A) 6 Guanine (G) 6 Cytosine (C) 12 Ribose 12 Phosphate 4 amino acid parts 4 tRNA

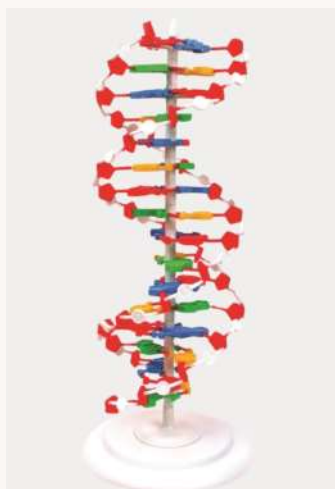

Item: 527577

DNA model, 50 cm, assemble

Same as 527565 but with 12 base pairs: 6 thymine (t), 6 adenine (A), 6 guanine (G),



Item: 527581

Sodium chloride

Molecule model of "Sodium Chloride". Contains 36 atomic spheres and 80 links. The model comes



Item: 527600

DNA model, large, for hanging

Large, beautiful DNA model that can be mounted on a tripod pole or hung from the ceiling. Displays DNA in double helix



Item: 561035

Bulb for tellurium, 561030

Bulb for tellurium, 561030



Item: 565712

Lens pen, cleaning pen for opt

Greasy and dusty lenses are now a thing of the past with this exciting product! The brush at one end removes dust and other debris from the lens surface and the



Item: 565715

Binoculars, Focus Action III, 8

New and improved version. Now with rubber armoring, twist-up eyepieces and larger field of view. Lightweight and compact



Item: 565717

Binoculars, 8 x 25

Practical and compact 8x25 binoculars with a very good field of view of 122 m at 1000 m distance. It draws sharply and has a close range of approx. 1 m. Comes with a



Item: 565719

Binoculars, 8 x 21

Compact 8 x 21 binoculars with a large field of view of 126 m at 1000 m distance. Close-up distance approx. 2.5 m.



Item: 565757

Monocular for smartphone, 7 x

Small monoculars that take up little space and are easy to carry, so you always have a little extra magnification in your back pocket. Works like a small mini telescope with 7x



Item: 565853

Telescope, tripod Velbon DV-7

A sturdy tripod that provides good stability and is therefore suitable for telescopic use. The legs can be placed in a "wide" position for extra stability. Equipped with



Item: 566130

Solar system, inflatable

Inflatable beach ball models of the Sun, 9 planets and the Moon, 11 models in total. The models are not to scale. Includes activity suggestions



Item: 544161

Gel tray for Edvotek M12, 7 x 14

Fits the M12 Dual electrophoresis devices (544155).



Item: 525000

Molecule construction set, stu

With this basic set you can build many different compounds in both inorganic and organic chemistry. 2 types of molecular



Item: 525010

Molecule construction set, org

With this basic set you can build many different compounds in organic chemistry. Two types of molecular structures can be built:



Item: 526000

Molecule construction set 001,

Basic kit that allows you to build organic compounds such as, hydrocarbons, alcohols, carboxylic acids as well as more complicated ones like vitamin C, nicotine



Item: 526010

Molecule construction set 00

Building kit that allows you to build most organic compounds such as hydrocarbons, alcohols, esters, ketones, aromatic compounds, amino acids,



Item: 526020

Molecule construction set 00

Organic and inorganic kit that offers endless possibilities for building organic and inorganic compounds and complex ions.



Item: 526040

Molecule construction set 007

Biochemical kit that allows you to build structures such as amino acids, peptides, mono-, di- and polysaccharides, nucleic acids, nucleosides,



Item: 526070

Molecule construction set 051,

Organic stereochemical student kit. Includes MOLYDOME hydrogen shells, which provide a good combination of calotte model and sphere model. 2 types of



Item: 526086

Molecule construction set, BA

An affordable molecule building kit containing 54 atoms and 24 bonds. The kit contains:
Number Name Color Holes

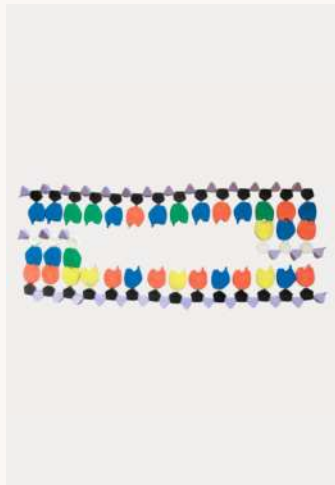

Item: 527654

Molecule model, DNA fingerpr

A plastic molecular model that demonstrates how DNA fingerprinting uses small pieces of primer to identify and possibly



Item: 528000

Bright Atom model, student

Bright Atom er en revolutionær og prisvindende atommodel, som giver den enkelte elev mulighed for at



Item: 528005

Bright Atom model, set

Bright Atom Science kit er et grundlæggende modelsæt for opbygning af et atoms indhold af protoner, neutroner, elektroner.



Item: 066705

Water bath, Edvotek, 1.8 L

Practical small water bath with stainless steel chamber. Temperature from room temperature to 95 °C. Comes with transparent plastic lid.



Item: 068010L

Memmert lid for water bath wi

Mounts on 068010 to turn this water bath into a shaker water bath. With frame for mounting shaker basket and accessories (not included). Shaking speed: 10-150



Item: 068011

Memmert Water Bath 17 L , wit

Solid, high-quality water bath from German Memmert.

User-friendly design and easy



Item: 076841

Objective 4x achromatic (100F

Lens with 4x magnification provides a fine first impression of any object lying on the cross table. Especially for the slightly less

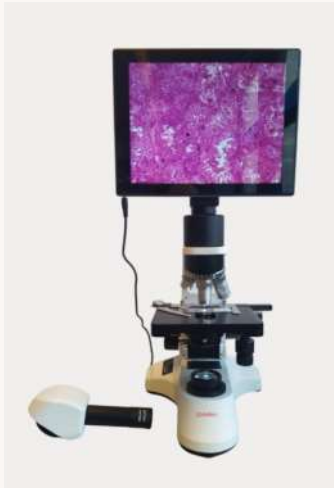

Item: 078220

Adapter for microscope and L

Adaptor for LCD monitor to fit most eyepiece diameters on microscopes and stereo loupes



Item: 079100

Plastic slides mailer – for ship

Plastic transport case for shipping a slide. Made of polypropylene. This small smart box fits one pc. micropreparation. The box



Item: 079121

Rhizobium radiculicola, nitrogen

Rhizobium radiculicola nitrogen-fixing bacteria.

A fantastic micro-preparation showing nitrogen-fixing Rhizobium



Item: 140002

Tape Measure, mini, 1,5 m

Minimum tape measure in a plastic cassette with key ring. The 150 cm long tape measure has a cm scale on one side and an inch scale on the



Item: 185708

Weather station Wifi W830

Ventus W830 Wi-Fi wireless weather station with temperature, wind and rain gauge. Ventus W830 is a robust weather station with a wide range of features. The



Item: 185760

Weather station, Davis Vantag

Get accurate weather data without any hassle! This wireless weather station has an impressive range of up to 300 meters in open terrain and between 60-120 meters



Item: 268800

Convection chamber, air

The Convection Chamber is designed to demonstrate the principle of convection in air. The simple and illustrative experiments help to clearly show the principles of



Item: 526085

Molecule construction set, CV

Plastic molecule building kit. The molecule building kit is made of hard plastic where the bonding



Item: 763081

Mini greenhouse S Plus Coco,

Is your garden small? In this manageable 27.5 x 11.5 x 11 cm S PLUS COCO greenhouse you can safely plant flowers,

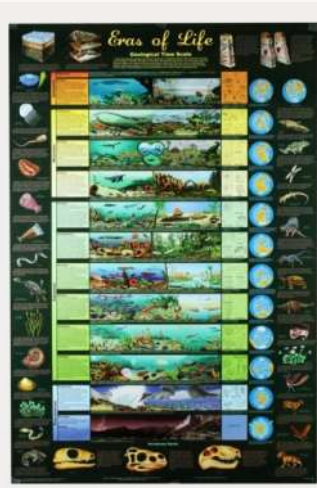

Item: 768057

The eras of life, poster

Laminated poster showing 12 different periods in geological history. For each period there are illustrations of animal and



Item: 770215

Skin, block model, Small

Small model of human skin. Practical format in soft and durable plastic. Size: 17 x 13 x 17.5 cm. Ideal for illustrating the



Item: 774060

Condom training, 20 models

To give students some practice using a condom properly, this penis model is a great tool. It is made of styrofoam and has two adhesive pads at the bottom,



Item: 774065

Condom pack

Pack size: 200 pieces (not sterile as they are not individually wrapped) Standard condom for practicing condom application



Item: 774575

Dicot Stem model, small

Model of stem from twokims. The model measures 36 x 24 x 17 cm. Wood tubs and sickle tubs are indicated in different colours and are clearly visible. The material is

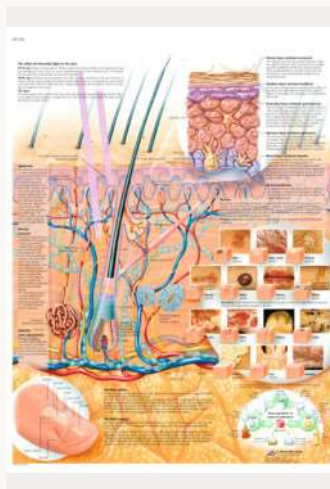

Item: 774735

Poster - The skin

Dive into the complex world of human skin with this poster about the skin - the largest human organ that is not only a visual delight but also a source of scientific insight.



Item: 778117

Edvotek 1116 Researching Alzh

In this experiment, students are brain scientists looking for Alzheimer's disease biomarkers. Students will explore potential biomarkers by analyzing simulated



Item: 796021

Inclined plate for ice compart

Inclined plate for the ice room in the Grøndlandspumpen (796020). You install the plate in the aquarium and pour ice into it so that you can see a thermohaline



Item: 799011

Tectonic plate model

A model of an underwater volcano forming new seabed. It also shows faults, fold mountains and deep trench formation.

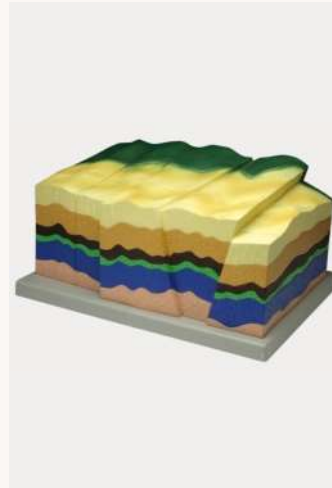

Item: 799013

Folds, faults and oil traps

When soil layers are compressed or stretched, faults can occur. Multiple faults or fractures can cause blocks to move up or down.



Item: 799015

Volcano, model

This simple model of a volcano makes it easy and fun to create your own erupting volcano. The volcano can be opened



Item: 799020

Stratovolcano, model

Nice hand-painted model of a stratovolcano (cone volcano). An incision has been made in the volcano so you can see the path of the lava flow to



Item: 799109

String, 120 m

Wall cord, white
Length: 120 meters



Item: NL180609

Sand ruler, 10 standard fractio

Sand ruler with 10 different fractions of sand grains.
Grain size: 63, 90, 125, 180, 250, 355, 500, 710, 1000, 1400 and 2000 µm.



Item: 076884

Lens 40x, achromatic

Standard achromatic objective with 40x magnification. Provides, together with a 10x eyepiece, a total magnification of 400x. REACH. 0.65 and springy



Item: 077458

Digital microscope with 7 inch

Small lightweight microscope / stereo magnifier with 7 inch LCD screen with a resolution of 1024x600 that can be tilted at an angle of 120 degrees for optimal



Item: 210840

The Rocket - building kit

The rocket is a building kit from Woodstein. The kit comes in a cardboard box with all parts included, as well as an extra rocket and building instructions.



Item: 210845

The Lava Lamp - building kit

The lava lamp is a kit from Woodstein. The kit comes in a cardboard box with all parts included, as well as building instructions.

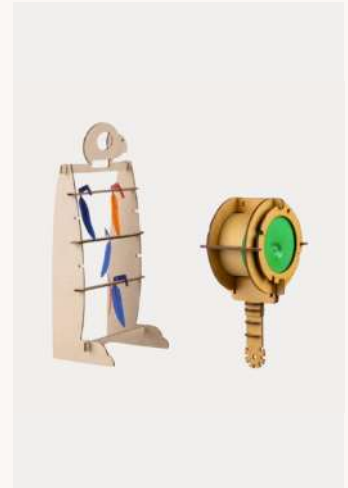

Item: 210850

The Vortex Cannon - building

The Vortex cannon is a kit from Woodstein. The kit comes in a cardboard box with all parts included, as well as building instructions.



Item: 776002

Amazon Rainforest Ecosystem

Print, cut out and assemble the Amazon Rainforest Ecosystem - one of the most diverse ecosystems on the planet. The model will show how species interact and



Item: 776004

Arctic Ecosystem - Origami O

Print, cut and assemble the Arctic ecosystem. The model shows how species interact and depend on each other to survive.



Item: 776006

Simple Photosynthesis - Origami

Print, cut out and assemble a plant that produces energy in sunlight. This model shows how this happens and what roles different parts of the plant play. Buy once, print



Item: 776008

Evolution - Origami Organelles

Evolution is explained in an engaging way with this fun board game. Players each have an island with a population of animals. The population is reduced by



Item: 776010

Phases of the Moon - Origami

Model of the moon, earth and sun. First, make the models of the moon, earth and sun. Then use the models to look at the phases of the moon starting with a new



Item: 776012

Simple Plant Cell - Origami Or

Learn more about cells with this colorful model. The model covers all main parts of plant cells (cell membrane, cell wall, chloroplasts, nucleus, chromosomes,



Item: 776014

Simple Animal Cell - Origami

Learn more about cells with this colorful model. The model covers all main parts of cells (cell membrane, nucleus, chromosomes, mitochondria). For more



Item: 776016

Bacteria - Origami Organelles

Explore different bacteria. Bacteria come in all shapes and sizes and were one of the earliest forms of life on our planet. However, they can also cause serious illness like



Item: 776018

DNA Structure - Origami Orga

Learn about DNA structure with this interactive model. Make base pairs and combine them to create a model of a DNA double helix. Learn about the importance



Item: 776020

Immune System - Origami Org

Make the immune system easy to understand. This innovative model provides an understanding of the cellular interactions of the immune system. Models helper T



Item: 776022

Leaf structure - Origami Orga

Learn how leaves are adapted to perform gas exchange and transpiration with this colorful model. Leaves are beautifully adapted to photosynthesis



Item: 776024

Seed Dispersal - Origami Org

Plants use many strategies to disperse their seeds to improve their chances of survival. These include wind, animals, water and explosive methods. This model shows



Item: 066690

Water bath BS30, circulation and cooling

Water bath with circulation and cooling from Nuve. This versatile water bath from Nuve is not only characterized by Nuve's high



Item: 077426

Microscope FS-1, binocular 60

A sturdy and versatile microscope with LED light and rechargeable battery. The microscope is an obvious choice for student use in primary, secondary and high



Item: 260814

Surface thermometer, Infrared

Practical handheld infrared thermometer in top quality for quick and contactless body temperature measurement. The thermometer can



Item: 052034

Sorting tray, junior 41 x 29 x 9

Very practical and very useful tray, especially for younger students. Bring the tray on excursions and collect plants and animals



Item: 039560

Hose clamp, white pp plastic

A small versatile hose clamp in white pp plastic. The clamp can be used to close soft plastic and silicone hoses with an



Item: 078693

Tweezers, plastic, 25 pcs

Easy-to-use tweezers for small jobs in the lab and more.

The tweezers measure 123 mm (l) x 22 mm (w) x 8 mm (t)

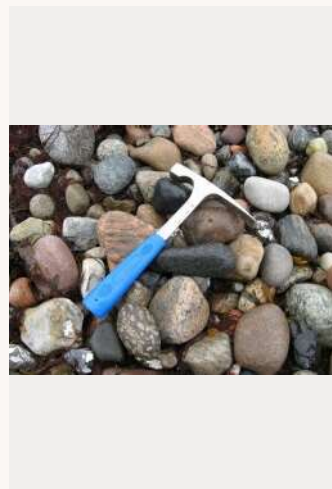

Item: 768260

Geologist hammer, chisel-shaft

Professional model with a hammer head that is flat at one end and chisel-shaped at the other. The hammer is covered with rubber on the shaft for a good and secure

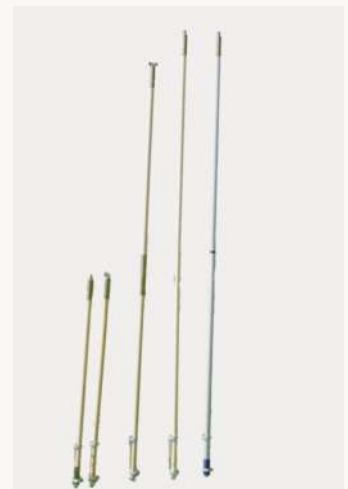

Item: 760625

Net handle, telescopic, 120 - 2

End shaft Type: telescopic shaft
Material: aluminum
Length: approx. 179 cm (extended), 101 cm (retracted)



Item: 760801

Economy model with stainless steel frame and replaceable sight (item no. 7608011), sight diameter of 16 cm.

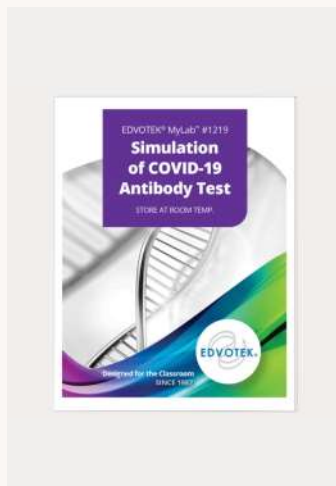

Item: 7781219

COVID-19 Antibody Test, ELISA

This kit tests via ELISA method whether 2 test persons have formed anti-SARS-CoV-2 antibody against

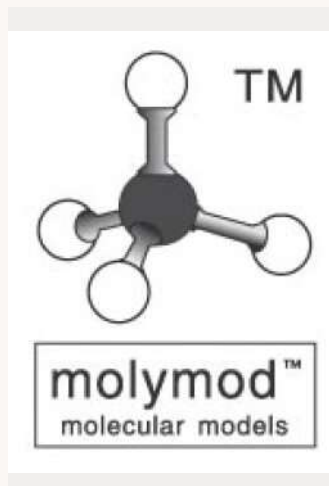

Item: 526501

Sphere, hydrogen, 1 hole

Plastic sphere for MOLYMOD molecular models

Material: Hydrogen



Item: 526507

Sphere, oxygen, 2 holes, 105 d

Plastic sphere for MOLYMOD molecular models

Fabric: Oxygen



Item: 526510

Ball, sulfur, 6 holes

Plastic ball for MOLYMOD molecular models
Material: Sulfur

Color: Yellow



Item: 526515

Ball, nitrogen, 3 holes

Plastic ball for MOLYMOD molecular models
Material: Nitrogen

Color: Blue

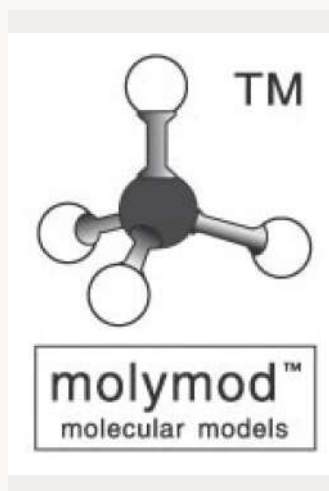

Item: 526518

Ball, carbon, 3 holes, VNU

Plastic ball for MOLYMOD molecule models

Fabric: Carbon

Color:



Item: 526519

Ball, nitrogen, 3 holes, square

Plastic ball for MOLYMOD molecular models
Material: Nitrogen

Color: Blue



Item: 526522

Ball, carbon, 4 holes

Plastic ball for MOLYMOD molecule models
Fabric: Carbon
Color: Black



Item: 527010

Tie rod, short, white

Plastic connector for MOLYMOD molecular models.
Length: Short (1.9 mm)
Color:



Item: 527020

Connecting link, medium, gray

Binding link for MOLYMOD molecular models.
Color: Gray
Dimension: "Medium" (



Item: 527030

Tie rod, long, gray

Plastic connector for MOLYMOD molecular models.
Length: Long (3.2 cm)
Color:



Item: 527050

Tie rod puller, tool

Molymod link puller for molecular models.



Item: 185840

CO₂ meter, digital

Smart CO₂ monitor that measures CO₂ content, humidity and temperature in the air.
Very useful device for



Item: 779210

Taste test, PTC test sticks

Practical test strips for testing students' ability to taste phenylthiocarbamide (PTC), which tastes distinctly bitter.
About 70% of the population

Tech & eng.

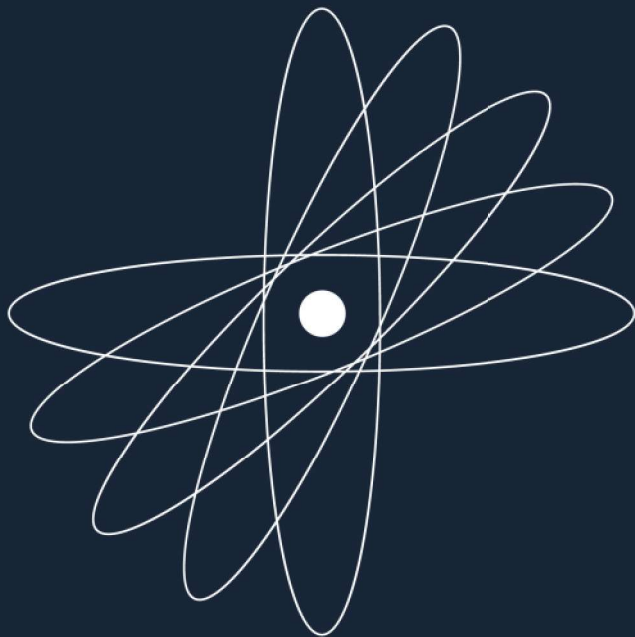



Item: 663039

Water pump 3 V - 4.5 V

Do you want to make your own self-watering greenhouse or a fascinating fountain or riverbed project? Then our water pump is designed to be an integral



Item: 663029

Starter kit for micro:bit

This micro:bit starter kit can be used to introduce how electronic components can be connected with micro:bit. Contents:



Item: 663021

Climate sensor board for micr

This MonkMakes sensor board allows you to detect sound levels, temperature and light levels. Records the sound level (



Item: 663000

Micro:bit processor (board onl

V2 is the latest version of the micro:bit processor board. Where the V1 version (the model sold in recent years) is used today, V2 can also be



Item: 660120

Arduino Starterkit

This beginner kit helps you with the basic steps of using the Arduino microprocessor and coding programs. The kit includes a breadboard that, along with its components,



Item: 660215

Edison creator's kit

Edcreate is a new accessory kit for the Edison robot. If you already have Edison robots, the kit allows you to expand your robots to create new and exciting programming with



Item: 660211

Spare Parts Pack for Edison

If you have a broken part on your edison robot, you can repair the damage yourself with this edison spare parts package.

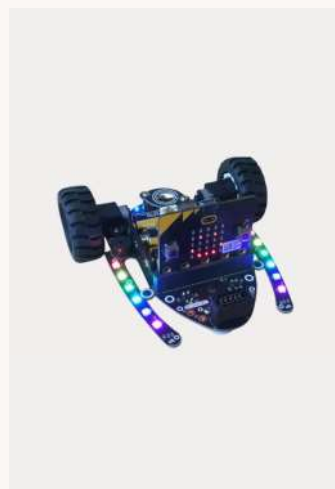

Item: 664585

Bit:Bot Robot til Micro:Bit XL

Bit:bot is tailor-made for the micro:bit universe and its diverse possibilities provide a number of advantages in use. A microbit processor board is NOT included, and the same



Item: 663180

IR sensor module, reflective

The module consists of an IR LED and an IR sensor that measures the reflected light. When the signal exceeds the preset level, the digital output switches to high. For



Item: 667630

Switches, Tactile with Buttons,

Push switches (15 pcs) with matching buttons (35 pcs) in seven different colors. Supplied in a compartmentalized plastic



Item: 667510

LED Kit, 5 Colors, 300 pcs

Combination box with both 3 and 5 mm LEDs. The set contains a total of 150 LEDs in 75 x 3 mm and 75 x 5 mm. The set contains five different



Item: 663470

Relay Module, 5 pcs.

Relay with one set of 10 A contacts. Can be used as both switch and circuit breaker. Should only be used for voltages below 30 V DC / 24 V



Item: 663150

PIR Sensor Module, 5 pcs.

The PIR sensor detects changes in the infrared "image" in the sensor's coverage area. This type of sensor is used, for example, in burglar



Item: 655020

Electronic Starter Kit

This electronics kit is aimed at the group of students who are experiencing their first encounter with electronics, and the kit is therefore best suited as an introductory



Item: 663480

RGB LED Module, Including R

With an RGB (red, green, blue) LED, you can mix the color of the light yourself. The necessary resistors are built in, so the module can be connected directly to an

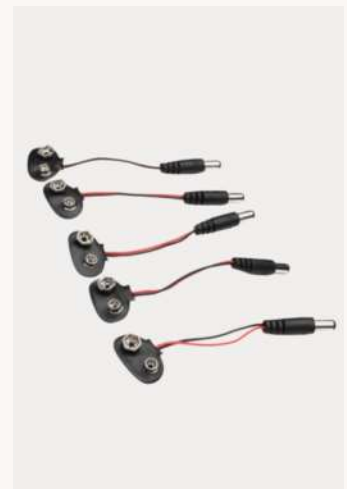

Item: 663810

Cable, 9 V Battery Clips, DC PI

Handy little adapter, e.g. for powering an Arduino Uno when not connected via USB cable.



Item: 616439

Capacitor, Electrolytic, 10 μ F, 6

Electrolytic capacitor (Elco) 63 V with a capacity of 10 μ F.

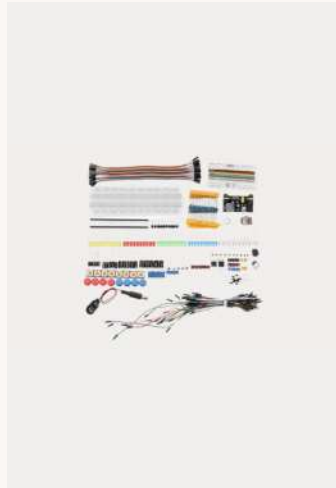

Item: 664010

Breadboard kit, Large

Large breadboard with 63 rows of 5 + 5 holes. Also 2 x 2 long tension buses (10 x 5 holes). Equipped with dovetail joints



Item: 664015

Breadboard kit, small

Breadboard with 30 rows of 5 + 5 holes. Also 2 x 2 long tension buses (5 x 5 holes each). Equipped with dovetail joints



Item: 664020

Breadboard, 830 Holes, 5 pcs.

Large breadboard with 63 rows of 5 + 5 holes. Also 2 x 2 long tension buses (10 x 5 holes). Equipped with dovetail joints

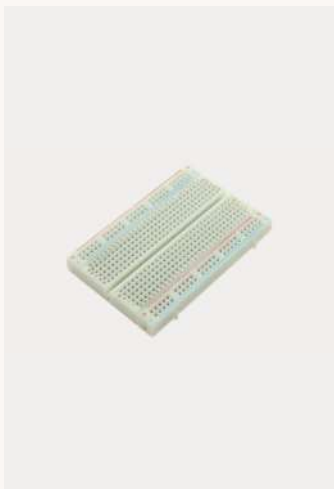

Item: 664030

5 x breadboard, 400 Holes

Breadboard with 30 rows of 5 + 5 holes. Also 2 x 2 long tension buses (5 x 5 holes). Equipped with dovetail joints so that several of these



Item: 663250

Angle Sensor Module, Potnet

A 10 k Ω potentiometer, mounted on PCB with pin legs - easy to use on breadboard. Switched between 5 V and 0 V, the potentiometer provides an



Item: 663270

Joystick module with switch, 5

Outputs two analog signals (x and y) and includes a switch that is activated by pressing the joystick button. Compatible with Arduino (5 V)



Item: 663410

Traffic Light Module, LED, 5 pc

Each of these modules consists of three LEDs, mounted like a traffic light (red, yellow, green). The LEDs are equipped with resistors so that the module



Item: 664040

Breadboard Cables, 10 cm, M

Assortment of short mini cables for breadboard: Male-male, female-female and male-female - 40 pieces of each.



Item: 660130

UNO R3 extended kit

Large kit with lots of accessories:
Processor board according to Arduino Uno R3 specifications



Item: 660140

UNO R3 basic kit

An affordable start to the Arduino universe.

- Processor board, pin-compatible with Arduino Uno R3



Item: 667110

Resistor kit 43 values, 860 pcs

Values from 1 Ω to 1 MΩ. Metal film resistors, 5% tolerance, 0.25 W. Ohm values: 1, 10, 20, 22, 33, 47, 51, 68, 75, 82, 90,



Item: 663420

Buzzer Module, Passive Trans

Passive piezo transducer that can reproduce different tones (like a microscopic speaker). Compatible with Arduino (5 V).



Item: 660150

UNO R3 incl. USB cable 5 pcs.

Five processor boards in the familiar Arduino Uno format. Bone-compatible with Arduino Uno R3. USB cables included.



Item: 655030

Student set Electricity and Ele

Basic electronics kit from Phywe, where 35 experiments can be conducted on the following topics:



Item: 663910

Robot car with 2 motors, Uno

Do-it-yourself robot car with ultrasonic sensor. Comes with wheels and geared motors, UNO microcontroller, motor controller, sensor shield, servo motor, tachometer



Item: 663002

Microbit board V2, GO with Ac

This micro:bit processor board is a package with all the parts needed to get started using the micro:bit processor.



Item: 663020

Microbit board V2, GO 10 pcs.

This micro:bit processor board is a 10 piece package with all the parts needed to get started using the micro:bit processor.



Item: 663905

Wheel for gear motor

This wheel is designed to fit the 660507 gearmotor. It has a solid plastic rim and rubber tires. They are perfect for creating your own buggy



Item: 663023

Ultrasonic Distance Sensor Br

This ultrasonic distance sensor for micro:bit from 4Tronix can be used by mini:bit and bit:bot XL to detect objects in front of the robot. On the front of both



Item: 663031

Breakout for BBC Micro:Bit

Breakout board for micro:bit processor board with pin header for direct connection to many different accessories (sensors etc.) with breadboard wires (664040)



Item: 663038

BBC Micro:Bit, Starter Kit

Beginner kit with accessories for micro:bit.
 - Breakout board with Edge connector for your micro:bit
 - On/Off switch with Blue



Item: 663007

2xAAA Battery Cage with JST

Battery holder for micro:bit - 2 x AAA



Item: 663018

Traffic Light for micro:bit

Traffic light for use with micro:bit. It can be connected with a hook hook connector.
Contains:
 1 x STOP: bit to micro:bit.



Item: 663030

Break out board and bread bo

Breakout board for micro:bit that is paired with a bread board, allowing the micro:bit processor to be combined with traditional electronic



Item: 663032

Connector Breakout Board for

This Edge Connector Breakout Board for micro:bit provides access to all the important pins on the bottom edge of the micro:bit processor



Item: 663036

Noise Pack for micro:bit

This audio package for micro:bit can be used to build the five exciting sound experiments. You can explore how to build and code musical instruments,



Item: 663037

Inventors Kit for micro:bit

Good expansion kit for micro:bit that combines micro:bit processor board and breadboard for use with common electronic components with



Item: 624710

Transistor, BC 547B

B547B Bipolar (BJT) NPN 45 volt, 300 MHz, 500 mW, 100 mA, 110 hFE transistor



Item: 603190

Resistor, 0.4 W, 10 kΩ

Solid resistors type SFR25, 0.4 W, metal film, 5%, E-12 series.
Resistance: 10 kOhm.



Item: 622010

LED, 3 mm, 20 mA, red

Red LED.
Diameter: 3 mm.
Current: 20 mA.
Voltage: 1.9 V.
Wavelength: 643



Item: 622020

LED, 3 mm, 20 mA, yellow

Yellow LED.
Diameter: 3 mm.
Current: 20 mA.
Voltage: 2.1 V.
Wavelength: 590



Item: 622030

LED, 3 mm, 20 mA, green

Green LED.
Diameter: 3 mm.
Current: 20 mA.
Voltage: 2.1 V.
Wavelength: 590



Item: 622110

LED, 5 mm, 20 mA, red

LED - red.
Diameter: 5 mm.
Current: 30 mA.
Voltage: 1.7 V - 2.5 V.
Light intensity: 80



Item: 622120

LED, 5 mm, 20 mA, yellow

LED - yellow.
Diameter: 5 mm.
Current: 20 mA.
Maximum voltage: 2.6 V.



Item: 622130

LED, 5 mm, 20 mA, green

LED - green.
Diameter: 5 mm.
Current: 20 mA.
Maximum voltage: 2.6 V.



Item: 622140

LED, white, 5 mm, 3.2 V, 20 mA

White LED.
Diameter: 5 mm.
Current: 20 mA, 3.2 V.
Luminance intensity: 8.09 cd.



Item: 604610

Resistor, 5 W, 10 Ω

Fixed resistors type AC05, 5 W, wire wound and cemented, 5%. Resistance: 10 Ohm



Item: 603250

Resistor, 0.6 W, 1 %, 100 kΩ

Solid resistors type SFR25, 0.4 W, metal film, 5%, E-12 series.
Resistance: 100 kOhm.



Item: 637630

Loudspeaker, mini, Ø50 mm, 8

Dimensions:
Diameter: 50mm.
Thickness: 16mm.



Item: 638281

Toggle switch, on-off-on, singl

Push button for plate mounting - red - Toggle switch two-way contact
Single pole and suitable for low voltage up to 125 volts.il



Item: 639225

Lamp holder E10 with solder ta

Mini lamp socket E10 with solder tabs, ideal for use with mini cords (106220)



Item: 637618

Buzzer, 6 V

(Speaker) Buzzer, 6 V, 25 mA, 360 Hz



Item: 603310

Resistor, 0.6 W, 1 %, 1 MΩ

Solid resistors type SFR25, 0.4 W, metal film, 5%, E-12 series.
Resistance: 1 MOhm.



Item: 638071

Pushbutton, red, normally off

Push button for plate mounting - red Suitable for plate mounting, low voltage.



Item: 638312

Switch, 2-Pole

Topole slide switch. Applicable for "power reversal" for an electric motor (forward - reverse).



Item: 624705

Transistor BC 517 NPN Darling

Transistor BC 517 NPN Darlington

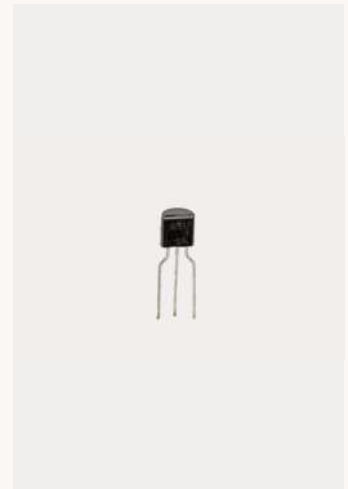

Item: 624720

Transistor, BC557B

Transistor.
Model: BC 557B.
Specification: PNP, 50 V - 0.1 A.



Item: 638320

Switch, 1 pole

Two-position, single-pole slide switch with 6 solder ears. Suitable for low voltage.



Item: 603130

Resistor, 0.6 W, 1%, 1 kΩ

Solid resistors type SFR25, 0.4 W, metal film, 5%, E-12 series. Resistance: 1 kOhm



Item: 603150

Resistor, 0.4 W, 2.2 Ω

Solid resistors type SFR25, 0.4 W, metal film, 5%, E-12 series. Resistance: 2.2 kOhm. Components (resistors,

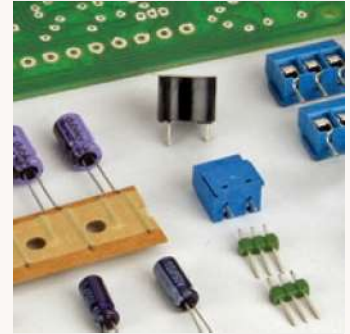

Item: 623300

Diode, 1N4148, 100 mA

Diode. Model: 1N4148. Specification: 75 V - 75 mA.



Item: 708025

Soldering iron set

Set consisting of 25 W soldering iron item no. 708010 and iron holder item no. 708410 and a roll of solder.



Item: 602970

Resistor, 0.6 W, 1%, 2.2 Ω

Solid resistors type SFR25, 0.4 W, metal film, 5%, E-12 series. Resistance: 2.2 Ohm



Item: 602990

Resistor 0.4 W, 4.7 ohm

Solid resistors type SFR25, 0.4 W, metal film, 5%, E-12 series. Resistance: 4.7 Ohm



Item: 641750

Leads, 10 different colours

The bag contains the following mounting wires:

- Red and black: 10 m



Item: 603090

Resistor, 0.6 W, 1%, 220 Ω

Fixed resistors type SFR25, 0.4 W, metal film, 5%, E-12 series.
Resistance: 220 Ohm.



Item: 623390

Diode, 1N4007, 1 A, 700 V

Diode.
Model: 1N4007.
Specification: 700 V - 1 A.



Item: 702011

Side cutter, mini

Length: 110 mm
Cutting width: 17 mm
- Nickel-plated tool steel with double spring
- Non-slip insulated grip



Item: 603100

Resistor, 0.4 W, 330 Ω

Solid resistors type SFR25, 0.4 W, metal film, 5%, E-12 series.
Resistance: 330 Ohm.



Item: 603010

Resistor, 0.4 W, 10 Ω

Solid resistors type SFR25, 0.4 W, metal film, 5%, E-12 series.
Resistance: 10 Ohm.



Item: 647550

Tip Activator

Contains a material that melts and forms a protective film on the hot soldering tip.
Extends the life of the soldering tip. Reduces



Item: 655000

Breadboard Electronics Set, 6

Electronics education - so everyone can join in.
Complete teaching material that encourages creativity and innovation in teaching.



Item: 603110

Resistor, 0.4 W, 470 Ω

Solid resistors type SFR25, 0.4 W, metal film, 5%, E-12 series.
Resistance: 470 Ohm.



Item: 703125

Wire stripper, self-adjusting

Automatic wire stripper. Professional quality with adjustable screw. Removes 0.6 -6 mm. wire.



Item: 647517

Solder, lead-free, 4 m, in dispe

Lead-free solder in a convenient holder from which the canister can be easily dispensed. 0.8 mm diameter x 4 meters



Item: 670163

Toggle switch

Small on-off switch. Good for model building.



Item: 670166

Buzzer, 3 V

Small buzzer, sounder, buzzer or buzzer. Gives a whistling sound when the circuit is closed. Remember red wire goes to



Item: 603050

Resistor, 0.6 W, 1%, 47 Ω

Solid resistors type SFR25, 0.4 W, metal film, 5%, E-12 series. Resistance: 47 Ohm



Item: 603055

Resistor 0.6W 1% 56 ohm

Fixed resistors type SFR25, 0.4 W, metal film, 5%, E-12 series. Resistance: 56 Ohm



Item: 655010

Solar energy experiment set

Solderless solar kit for fun solar projects. 10 exciting projects with user-friendly instructions. The instructions are in English. Completely solder-free



Item: 660200

Edison robot - Version 2

Edison (ver. 2) is a robust robot designed for education and innovation. The robot can be controlled in several different ways, so it



Item: 660205

Edison, activitymat

This activity mat EdMat is in A1 size and is used for the robot Edison. The track is printed in vinyl and is therefore easy to wipe clean so the mat can be



Item: 609023

Resistor, NTC, 1/2 W, 47 Ω

Philips series 642 non-linear resistor, 0.5 W. Type: NTC. Resistance: 47 Ohm / 25 degrees Celsius.



Item: 609420

LDR Resistor

Non-linear resistance. 200 V Type: LDR. Resistance: 6 kOhm - 1 MOhm.



Item: 603070

Resistor, 0.6 W, 1%, 100 Ω

Solid resistors type SFR25, 0.4 W, metal film, 1%, E-12 series. Resistance: 100 Ohm.



Item: 602950

Resistor, 0.6 W, 1%, 1 Ω

Solid resistors type SFR25, 0.4 W, metal film, 5%, E-12 series. Resistance: 1.0 Ohm



Item: 603035

Resistor, 0.6 W, 1%, 27 Ω

Fixed resistors type SFR25 of 0.6 W. Type: metal film, 1%, E-12 series. Resistance: 27 Ohm



Item: 616802

Capacitor, 10 μF 50V

Electrolytic capacitor 10μF 50V - 100 pcs



Item: 622450

Phototransistor PT202C

Osram Opto SFH 3310, Phototransistor, Hole Mount, 3 mm (T-1) Enclosure, 150° Infrared/Ultraviolet/Visible Light (Pack of 10)



Item: 638050

Switch

Minipush button with 5 mm leg spacing. Ideal for use in breadboards. Max. voltage DC: 12 V Max. current: 50 mA.



Item: 660202

Edison robot V.3

Edison V.3 is a robot that can be programmed to be controlled via block programming (Edblocks or Edscratch) and can be used by everyone from the first

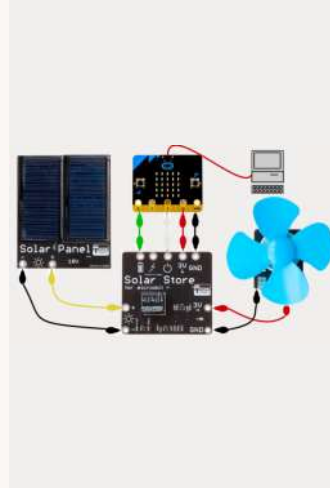

Item: 663034

Solar Experimenters Kit for mi

The kit consists of a solar panel and a storage unit that stores the energy converted by the solar cells, a low-energy light bulb, and a motor with blades that runs on



Item: NL115110

Connecting link

Locktronics LK5250 connection straight

FREDEKIKSEN™ [Scientific]

*Viaduktvej 35
6870 Ølgod
+45 7524 4966
export@frederiksen-scientific.com
export.frederiksen-scientific.com/*